

4-bit I/O CONNECTION REAL TIME CLOCK MODULE

RTC-58321/58323

- Built-in crystal unit allows adjustment-free efficient operation.
- Incorporating time counter (hour, minute, sec.) and calendar counter (year, month, day of week).
- Either 12 h or 24 h selectable and leap year automatically adjustable.
- Standard signal output selectable among a choice of 1024 Hz, 1 sec., 60 sec., and 1 hour.
- Provided with counter start, stop and reset functions.
- Data transmission is by 4-bit bidirectional bus line and memory read and write method.
- Low current consumption and backup function provided.

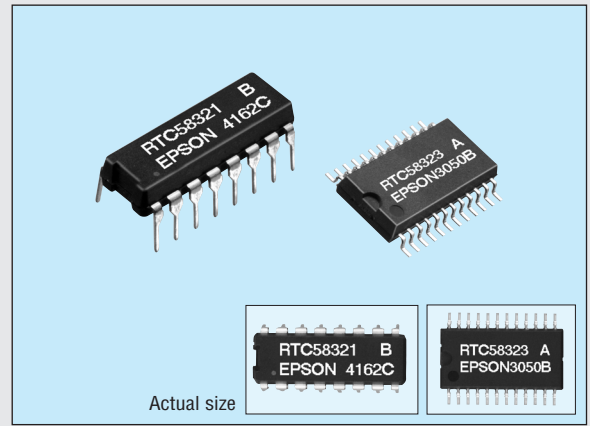

Specifications (characteristics)

Absolute Max. rating

Item	Symbol	Condition	Specifications	Unit
Power source voltage	V_{DD}	$T_a=+25\text{ }^\circ\text{C}$	-0.3 to 6.5	V
Input and output voltage	$V_{I/O}$		-0.3 to $V_{DD}+0.3$	
storage temperature	T_{STG}	—	-55 to +85	$^\circ\text{C}$
Soldering condition	T_{SOL}	RTC-58321	Under +260 $^\circ\text{C}$ within 10 s (lead part) (package should be less than +150 $^\circ\text{C}$)	
		RTC-58323	Twice at under +260 $^\circ\text{C}$ within 10 s or under +230 $^\circ\text{C}$ within 3 min.	

Operating range

Item	Symbol	Condition	Specifications	Unit
Operating voltage	V_{DD}	—	4.5 to 5.5	V
Operating temperature	T_{OPR}	RTC-58321	-10 to +70	$^\circ\text{C}$
		RTC-58323	-30 to +85	
Data holding voltage	V_{DH}	—	2.2 to 5.5	V
CSI data holding time	t_{CDR}	Refer to the data holding timing	0 Min.	μs
Operation restoring time	t_r			

Frequency characteristics and current consumption characteristics

Item	Symbol	Condition	Specifications	Unit	
Frequency tolerance	$\Delta f/f_0$	$T_a=+25\text{ }^\circ\text{C}$ $V_{DD}=5\text{ V}$	58321 A	± 10	$\times 10^{-6}$
			58321 B	± 50	
			58323	5 ± 20	
Frequency temperature characteristics	—	-10 $^\circ\text{C}$ to +70 $^\circ\text{C}$ (+25 $^\circ\text{C}$ reference temperature)	+10/-120		
Aging	f_a	$V_{DD}=5\text{ V}$, $T_a=+25\text{ }^\circ\text{C}$, first year	± 5 Max.	$\times 10^3/\text{year}$	
Shock resistance	S.R.	Three drops on a hard board from 750 mm or 29400 $\text{m/s}^2 \times 0.3\text{ ms} \times 1/2$ sine wave $\times 3$ directions	± 10 Max.	$\times 10^{-6}$	
Current consumption	I_{DD1}	$V_{DD}=5\text{ V}$, $CS_1=0\text{ V}$	40 Max.	μA	
	I_{DD2}	$V_{DD}=3\text{ V}$, $CS_1=0\text{ V}$	20 Max.		

DC characteristics

Item	Symbol	Condition	Min.	Typ.	Max.	Unit	Applicable terminal
"H" input voltage	V_{IH1}	—	3.6	—	—	V	Input other than CS_1
"H" input voltage	V_{IH2}		$V_{DD}-0.5$	—	—		
"L" input voltage	V_{IL}	—	—	—	0.8	—	—
"L" output voltage	V_{OL}		$I_{OL}=1.6\text{ mA}$	—	—		
"L" output current	I_{OL}	$V_O=0.4\text{ V}$	1.6	—	—	mA	—
"H" input current	I_{IH}	$V_I=5\text{ V}$	10	30	80	μA	Input other than D_0 to D_3
"L" input current	I_{IL}	$V_I=0\text{ V}$	—	—	-1		
Input leak current	I_{LIH}	$V_I=5\text{ V}$	—	—	1	μA	D_0 to D_3
Input off leak current	I_{LIL}	$V_I=0\text{ V}$	—	—	-1		
Input capacity	C_I	$f_{\text{input frequency}}=1\text{ MHz}$	—	5	—	pF	—
Oscillation start-up time	t_{OSC}	$V_{DD}=5\text{ V}$ $T_a=+25\text{ }^\circ\text{C}$	1.5	3.0	—	s	Busy output

Terminal connection

RTC-58321

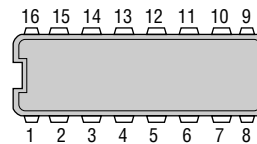

No.	58321	No.	58323
1	CS_2	1 to 4	N.C
2	WRITE	5	CS_2
3	READ	6	WRITE
4	D_0	7	READ
5	D_1	8	D_0
6	D_2	9	D_1
7	D_3	10	D_2
8	GND	11	D_3
9	ADDRESS WRITE	12	GND
10	BUSY	13	ADDRESS WRITE
11	STOP	14	BUSY
12	TEST	15	STOP
13	CS_1	16	TEST
14 to 15	N.C	17	CS_1
16	V_{DD}	18 to 24	V_{DD}

RTC-58323

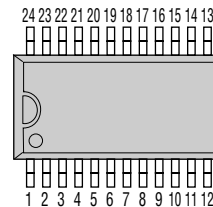

● NC is not connected internally.

External dimensions

(Unit: mm)

RTC-58321

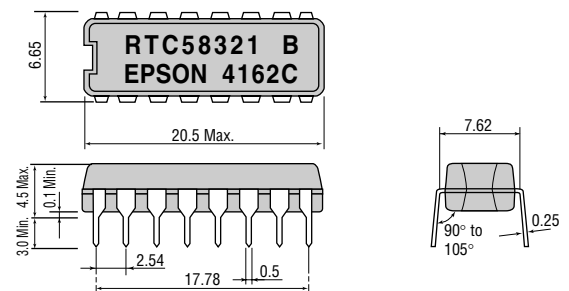

RTC-58323

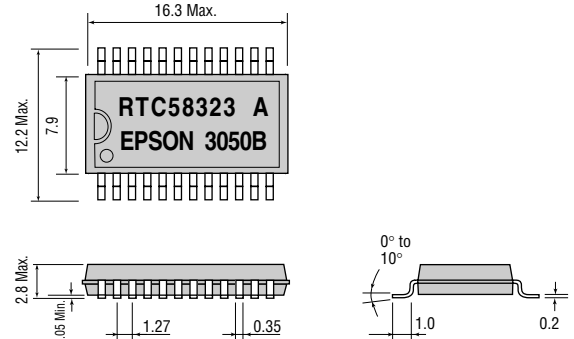

Supplement

0= "L" level 1= "H" level

Item	Description																									
* mark	Writable. Recognized as 0 while in read mode																									
24/12	"1" =24 h mode, "0" =12 h mode																									
PM/AM	"1" =PM, "0" =AM. In 24 h mode, this will be "0"																									
D ₃ and D ₂ of 10 days digit	Used to select leap year. Calculated according to the surplus after dividing 10 year digit by 4 <table border="1" style="margin-left: 20px;"> <thead> <tr> <th>Calendar</th> <th>D₃</th> <th>D₂</th> <th>Surplus after dividing 10 year digit by 4</th> <th>Example of leap year</th> </tr> </thead> <tbody> <tr> <td>Gregorian calendar</td> <td>0</td> <td>0</td> <td>0</td> <td>96, 00</td> </tr> <tr> <td></td> <td>1</td> <td>1</td> <td>3</td> <td></td> </tr> <tr> <td>Spare</td> <td>1</td> <td>0</td> <td>2</td> <td></td> </tr> <tr> <td></td> <td>1</td> <td>1</td> <td>1</td> <td></td> </tr> </tbody> </table>	Calendar	D ₃	D ₂	Surplus after dividing 10 year digit by 4	Example of leap year	Gregorian calendar	0	0	0	96, 00		1	1	3		Spare	1	0	2			1	1	1	
Calendar	D ₃	D ₂	Surplus after dividing 10 year digit by 4	Example of leap year																						
Gregorian calendar	0	0	0	96, 00																						
	1	1	3																							
Spare	1	0	2																							
	1	1	1																							
Reset register	These selections are for resetting 5-stage and the busy circuit after 1/2 ⁵ frequency stage. Resetting is activated by latching this code on to the address latch and setting WRITE=H																									
Standard signal register	By latching this code to the address latch and setting READ to H, the standard signals will be output at D ₀ to D ₃																									

- Note:
- Do not enter erroneous data for clock.
 - This may result in time keeping error.
 - Do not change STOP more than once while in BUSY mode.

Switching characteristics

Write & read mode

(V_{DD}=5 V±0.5 V)

Item	Symbol	Condition	Min.	Typ.	Max.	Unit.
CS setup time	t _{CS}	—	0	—	—	μs
Address setup time	t _{AS}		0.5			
Address write pulse width	t _{AW}		0.1			
Address hold time	t _{AH}		0			
Data setup time	t _{DS}		2			
Write pulse width	t _{WW}		0			
Data hold time	t _{DH}		—			
Read inhibit time	t _{RI}		—			
Read access time	t _{RA}		—			
Read delay time	t _{DD}		—			
CS hold time	t _{CH}	0	—			

*1 t_{RA}=1 μs+C x R x ln [V_{DD}/(V_{DD}-V_H)]
 C: Data line capacity
 R: Pull-up resistance
 V_H: "H" input voltage connected to the data line
 ln: Natural logarithm

Date holding timing

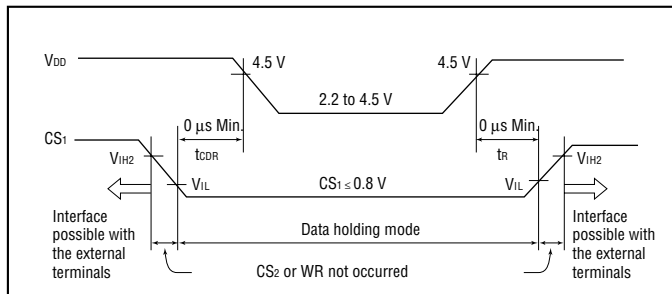

Register table

Address	D ₃	D ₂	D ₁	D ₀	Name of register	D ₃	D ₂	D ₁	D ₀	Count	Note
	A ₃	A ₂	A ₁	A ₀		D ₃	D ₂	D ₁	D ₀		
0	0	0	0	0	S ₁	S ₈	S ₄	S ₂	S ₁	0 to 9	1 - sec. digit register
1	0	0	0	1	S ₁₀	*	S ₄₀	S ₂₀	S ₁₀	0 to 5	10 - sec. digit register
2	0	0	1	0	MI ₁	mi ₈	mi ₄	mi ₂	mi ₁	0 to 9	1 - min. digit register
3	0	0	1	1	MI ₁₀	*	mi ₄₀	mi ₂₀	mi ₁₀	0 to 5	10 - min. digit register
4	0	1	0	0	H ₁	h ₈	h ₄	h ₂	h ₁	0 to 9	1 - hour digit register
5	0	1	0	1	H ₁₀	24/12	PM/AM	h ₂₀	h ₁₀	0 to 2 or 0 to 1	10 - hour digit register
6	0	1	1	0	W	*	W ₄	W ₂	W ₁	0 to 6	Week register
7	0	1	1	1	D ₁	d ₈	d ₄	d ₂	d ₁	0 to 9	1 - day digit register
8	1	0	0	0	D ₁₀	Leap year selection		d ₂₀	d ₁₀	0 to 3	10 - day digit register
9	1	0	0	1	MO ₁	mo ₈	mo ₄	mo ₂	mo ₁	0 to 9	1 - month digit register
A	1	0	1	0	MO ₁₀	*		mo ₁₀		0 to 1	10 - month digit register
B	1	0	1	1	Y ₁	y ₈	y ₄	y ₂	y ₁	0 to 9	1 - year digit register
C	1	1	0	0	Y ₁₀	y ₈₀	y ₄₀	y ₂₀	y ₁₀		10 - year digit register
D	1	1	0	1	—	*					Reset register
E	1	1	1	0	—	1 hour	1 min.	1 sec.	1024 Hz		Standard signal register
F	1	1	1	1	—						

Write and read timing

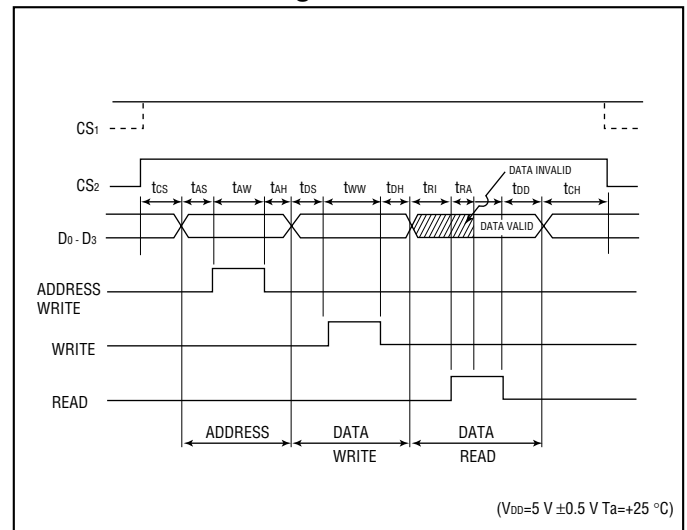

Block diagram

