

Quadcolor™ I Operation Manual

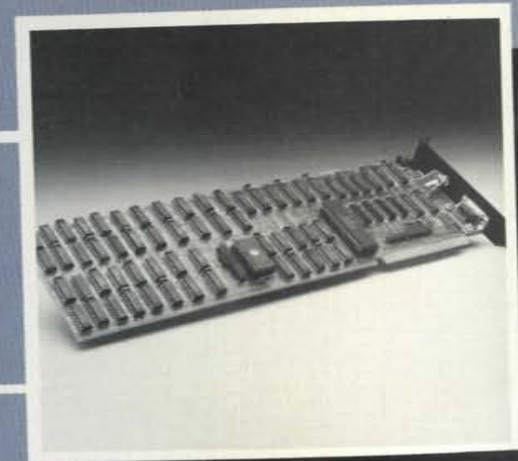

4355 International Blvd. / Norcross, Ga. 30093 / (404) 923-6666
TWX 810-766-4915 (QUADRAM NCRS)

PART NO. 9520-1



Quadcolor™ I Operation Manual

Quadcolor I Operations Manual

Before attempting to install Quadram's Quadcolor I read this operations manual thoroughly. Should you experience difficulty either in the installation or operation of the board, contact your local computer dealer for assistance.

© Copyright 1984 by Quadram Corporation. All Rights Reserved

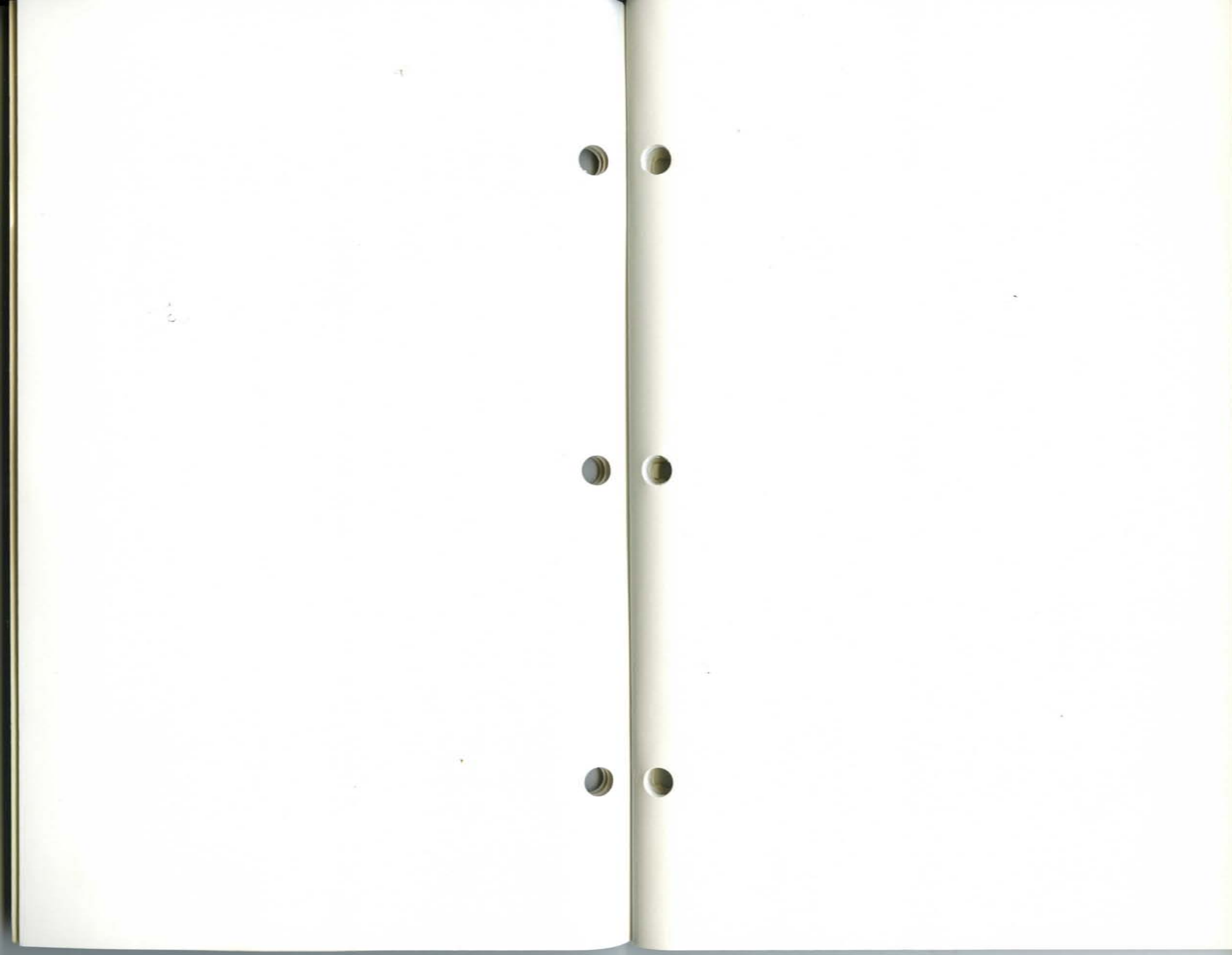

CONTENTS

PAGE

INTRODUCTION	1
Quadcolor I	1
The Quadcolor I Package	2
Structure of the User's Manual	3
INSTALLATION	4
Opening the PC	4
Inserting Quadcolor I	7
Cabling Quadcolor I	8
OPERATION	10
OPERATIONAL DESIGN	11
Major Block Definitions	12
6845 CRT Controller	12
I/O Registers	12
Display Buffer	12
Character Generator	13
Timing Generator	14
Wait State Generator	14
Composite Color Generator	14
Address Decoders	15
MODES OF OPERATION	16
Text	16
Medium Resolution Graphics	20
High Resolution Graphics	23
6845 CRT Controller	24
Mode Control Register	26
Color Select Register	28
Status Register	29
Clear Light Pen Strobe	30
Set Light Pen Strobe	30
Quadcolor I Register	31
Character Generator	33

TIPS & TECHNIQUES	39
Alternate Bank Selection Technique	39
Fast Memory Accessing	40
J5 Description	40
Alternate Character Set Uses	42
Third Medium Resolution Palette	42
IBM Technical Reference Manual	43
Bank Swapping	43

TABLES

Table 1: 256 Character Set	17
Table 2: Text Memory Allotment	18
Table 3: Summary of Available Colors	18
Table 4: Memory Mapping for the First Page of Display Memory in 80 Column Mode	20
Table 5: Color Table	21
Table 6: Medium Resolution Color Sets	21
Table 7: Medium Resolution Graphics Storage Map	22
Table 8: 6845 Program Parameters	25
Table 9: Contents of the Mode Control Register	27
Table 10: IBM "A" Dot Pattern	34
Table 11: Custom "A" Dot Pattern	37

FIGURES

Figure 1: Rear Panel of the IBM Personal Computer	5
Figure 2: Sliding the Cover Off the PC Chassis	6
Figure 3: Cabling to a Monitor	8
Figure 4: Cabling to a Light Pen	9
Figure 5: Medium Resolution	21
Figure 6: High Resolution Pixel Format	23
Figure 7: Pin Numbers for J6	35
Figure 8: Connections to J6	35
Figure 9: J3 Pin Assignments	41

WARRANTY PROVISIONS

The Quadram Corporation warrants this product to be in good working order for a period of one year from the date of purchase as a new product. Should this product fail to perform properly any time within that one year period, Quadram Corporation will, at its option, repair or replace this product at no cost except as set forth in this warranty. Replacement parts or products will be furnished on an exchange basis only. Replaced parts and/or products become the property of Quadram Corporation. No warranty is expressed or implied for products damaged by accident, abuse, misuse, natural or personal disaster, or unauthorized modification.

Warranty service described herein may be obtained by delivering this product, during the one year warranty period, to any authorized Quadram Dealer or to Quadram's Factory Service Center located at 4355 Intl. Blvd., Norcross, Georgia, 30093. Whether delivering to a Dealer or to the Factory, product must be accompanied by proof of purchase date. If shipped by U.S. Mail or any common carrier, owner agrees to insure and accept all liability for loss or damage to this product, to prepay all shipping charges, and to use shipping container equivalent to original packaging.

WARRANTY LIMITATIONS

All warranties for this product expressed or implied, including merchantability and fitness for a purpose, are limited to a one year duration from date of purchase, and no warranties, expressed or implied, will apply after that period.

If this product does not perform as warranted herein, owner's sole remedy shall be repair or replacement as provided above. In no event will Quadram Corporation be liable to any purchaser for damages, lost revenue, lost wages, lost savings, or any other incidental or consequential damages arising from purchase, use or inability to use this product, even if Quadram has been advised of the possibility of such damages.

Periodic updates or changes to this material will be made in new editions of this publication.

Requests for dealer information, comments or other inquiries may be addressed to: Quadram Corporation 4355 Intl. Blvd., Norcross, Georgia 30093. Quadram Corporation has no obligation to return or hold confidential any material or information you supply unless arrangements are made pursuant to Quadram's receipt of said information.

INTRODUCTION

Quadcolor I

Quadcolor I is a plug-in enhancement board for the IBM PC and PC XT. Using it along with a color display screen, Quadcolor I greatly enhances the graphics capabilities of your Personal Computer.

Among the advantages of Quadcolor I is the fact that it is hardware and software compatible with the PC. With most other color graphic cards you must first install special software into the system before using any of the card's features. But Quadcolor I works with the software already in the PC.

Additionally, Quadcolor I offers twice the memory found on IBM's color graphics card: 32K of RAM. This lets you store two complete pages of data in graphics mode and up to 16 pages in text mode. You can also create the affect of animation by using a simple BASIC command to instantly swap visual pages.

Another advantage Quadcolor I offers is that it allows for the use of two true colors in high resolution mode. Instead of black and white, you can now make the foreground and the background each one of the sixteen colors normally available only in text mode.

Display memory on the Quadcolor I can be accessed at any time by the microprocessor without causing glitches on the screen. Quadcolor I will also support a light pen for fully controlled graphics work and contains a connector for an RF modulator so you may use the card with a standard NTSC color television set.

The Quadcolor I Package

One nice thing about using Quadcolor in your system is that it is very "system-friendly". There is no special software to install, no new commands to learn. The board is compatible with the Personal Computer. The entire Quadcolor I package consists of just two parts: the Quadcolor I printed circuit board and the operations manual.

When you first get the Quadcolor home from your retail store, open it to make sure both parts are there. (Of course, since you are reading this right now, we know the operations manual was not left out.)

Check to make sure that the board has not been damaged in any way. And be sure that the jumpers located on the center of the board (see figure 3) are in place.

If your Quadcolor looks damaged, or if any parts are missing, contact your local retailer as soon as you can. He will be happy to replace anything that is missing.

Structure of the User's Manual

Quadcolor I is easy to use. Reading this manual will make it a little easier. It is structured so you can get the board up and running in your system in no time. Each of the three sections gives you a little more in depth information on the board.

Section II concerns itself with installing the Quadcolor I in your PC. Section III and IV give operational details concerning the use of the Quadcolor board. For many users these sections might be considered optional reading. (Since the board works so closely with the PC you may wish to simply plug Quadcolor in and ignore it, treating it just like the IBM color graphics adapter). But if you wish to take advantage of the unique characteristics of Quadcolor I, you will find the necessary information here. The last section - section V - is for your reference.

INSTALLATION

Opening the PC

Quadcolor I is easily installed in your PC system. You need only remove the computer's chassis cover, snap the card into one of the available expansion slots, cable the Quadcolor according to your system configuration, then reinstall the cover and turn the PC on. All you will need for this operation is a standard screwdriver and a little patience.

WARNING: Before opening the Personal Computer make sure all power has been turned off to the computer and all power cords have been disconnected from any power source you are using. Installing expansion cards in the PC with power on could result in damage to the PC or the expansion card.

Now that you are ready to begin, let's make sure the Quadcolor is ready, too. To make sure of this you need only check one thing. As illustrated below (figure 3, page 8) there is a set of jumpers towards the center of the Quadcolor. Before the board can work properly in your PC you must make sure these jumpers are in place. If they are not, Quadcolor 1 will fail to operate.

With the jumper in place, you can now begin the installation process. With the power off and all power cables disconnected, the PC cover is easy to remove. First, you should remove the keyboard cable from the back panel plug. And, if your system already has one, you should remove your monitor cable, too. This will give you a little working room. Next, turn the computer around so that the rear panel is facing you as shown below.

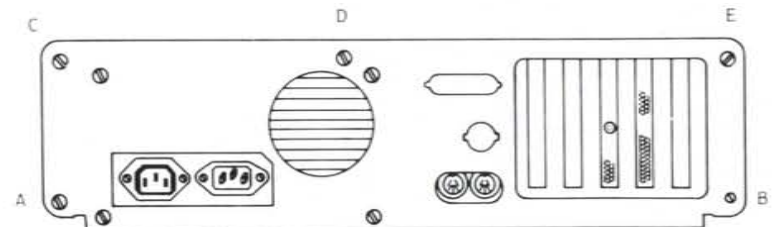

Figure 1: Rear panel of the IBM Personal Computer

With a small standard screwdriver loosen the two screws found on the lower corners of the rear panel. These are marked A and B in figure 1. (Note: On newer PCs, you may also have to loosen the screws marked C, D, and E.) Remove the screws and put them in a safe place for later.

Now gently slide the cover to the PC forward, away from the rear panel, lifting the front edge slightly as shown in figure 2. The cover should slide off easily, leaving the PC chassis and system board exposed.

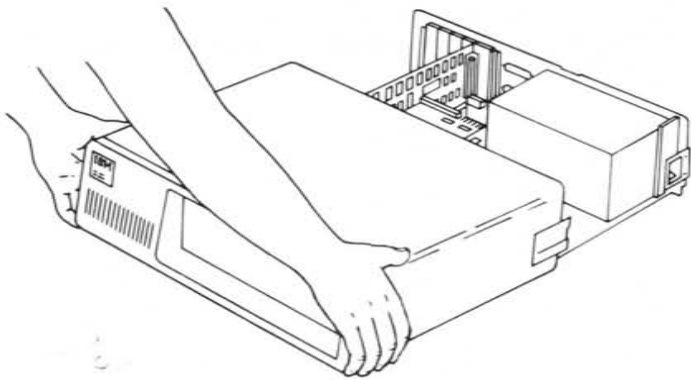

Figure 2: Sliding the cover off the PC chassis.

Put the cover aside. Now, if you look down on the system board from the rear panel you will see the internal circuitry of the personal computer. To the left will be a large black or silver box housing the power supply. Toward the front will be the disk drive unit(s). And on the lower right corner of the system board will be found five (possibly eight, depending on the system you own) elongated connectors called expansion slots.

Some of these expansion slots may already contain expansion boards. They might hold extra-memory cards, a serial port adapter, or maybe Quadram's multifunction Quadboard. In any case, one of the expansion slots will be needed for the Quadcolor card.

When installing the Quadcolor I in your PC system certain system board switches must be set to reflect a color graphics adapter card. For this information consult your IBM Guide to Operations Manual.

Inserting the Quadcolor I

Inserting the Quadcolor into the expansion slot is easy. First if you have any other type of color graphics card you must remove it from your system. Quadcolor I will not work with any other color card (It *will* work with a monochrome card so if you have one in your system you can leave that in).

Along the lower edge of Quadcolor I you will find a rim of gold fingers forming what is called an edge connector. This connector is designed to fit into the expansion slot. Plug the card into the expansion slot by inserting the connector into the slot first and then pushing down on the card. It should snap into place with the metal end plate sitting flush against the corresponding rear panel opening. There should also be a plastic card guide at the other end of the Quadcolor board that fits between the edge of the board and the front panel of the chassis to help hold the board in the proper place. This card guide will snap onto the inside of the front chassis panel in line with the expansion slot being used to hold the Quadcolor board. Snap the card guide in place before inserting the Quadcolor board into the expansion slot.

You can secure the board in place by screwing the end plate down to the top of the computer chassis with the screw provided in the screw hole opening over the corresponding rear panel slot.

With it properly installed in the system expansion slot, Quadcolor I can now be cabled to your monitor and, if you so choose, to a light pen.

Cabling the Quadcolor I

Quadcolor I can be cabled to any kind of color monitor. If your system uses an RGB or IRGB Direct Drive color monitor, the cabling is done through the male 9-pin connector located at the center of the board's end plate. If your system uses a NTSC Composite signal monitor the cabling is done through the RCA phono plug just above the 9-pin connector on the Quadcolor's end plate. And, finally, if your system uses a regular NTSC home color television set the cabling is accomplished by installing an RF modulator (available at most electronics stores) to the set of 4 pins (with pin 2 missing) labeled P1 on the Quadcolor printed circuit board and then cabling this modulator to your television set.

The following three illustrations detail the necessary cabling connections from the Quadcolor I to each of the three color monitor types.

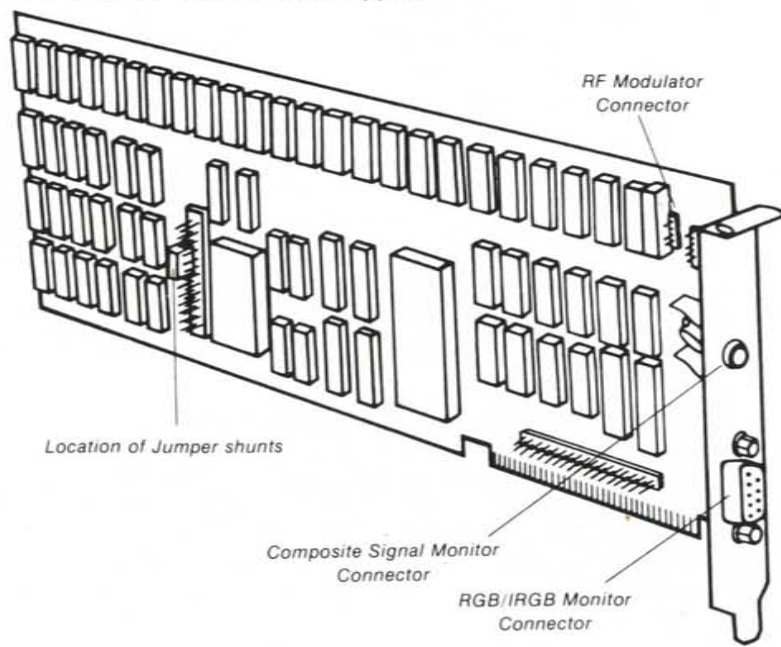

Figure 3: Cabling the Quadcolor I to a Direct Drive RGB or IRGB monitor; and an RF modulator. Note position of jumpers.

If you are using one in your graphics work, you will want to install the light pen now. Next to the RF modulator's P1 connector on the Quadcolor's printed circuit board (see figure 3 above) is a 6 pin connector (with pin 2 missing) labeled P2. The light pen is installed here.

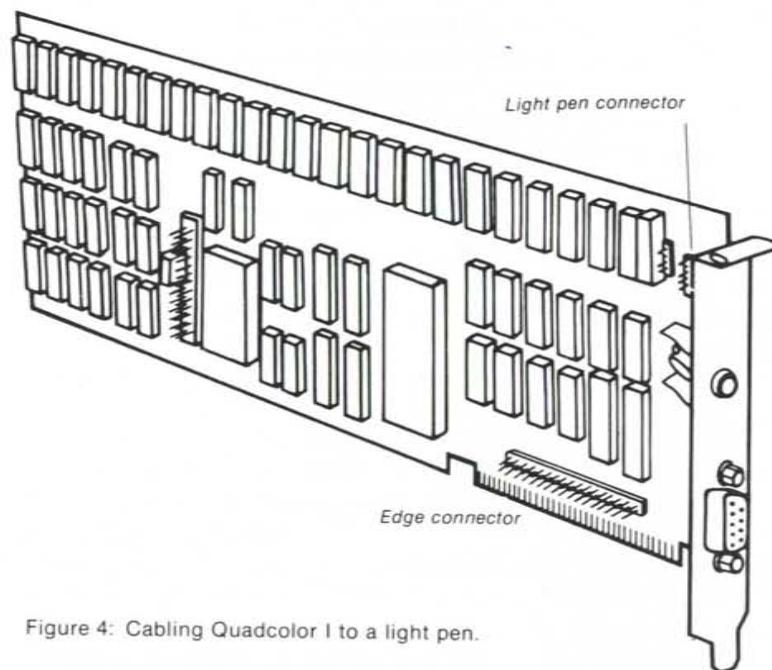

Figure 4: Cabling Quadcolor I to a light pen.

With all the necessary cables attached to Quadcolor I, the Personal Computer cover can now be reinstalled in the computer chassis. This is done by simply following the cover removal procedure in reverse. Slide the cover back over the chassis until it seats flush against the rear panel, tighten it in place with the screws you removed earlier, connect any power cables you removed, reattach the keyboard and the monitor, and you are now ready to turn the computer on.

OPERATION

Quadcolor I is a color graphics adapter for the IBM Personal Computer. It provides the interface between the computer and a video display device. The display device may be a black-and-white or color composite monitor, a direct drive IRGB (or RGB) monitor, or a standard color television set (which requires the addition of an RF modulator). Quadcolor I operates in several modes to display text and graphics. It is plug compatible with IBM's Color Graphics Adapter. No special software is needed to use Quadcolor I as a replacement for IBM's card.

In addition to being plug compatible with IBM's Color Graphics Adapter, Quadcolor I features several enhancements. These enhancements include twice as much memory as IBM's color card, faster access to the display memory by the processor, the choice of sixteen colors for foreground and background colors in high-resolution mode, and expansion connectors to interface to Quadcolor II for even higher resolution graphics.

Quadcolor I also contains a light pen interface as well as a connector for an RF modulator. An RCA phono plug is provided for connection to composite monitors and a 9-pin D-type connector is provided for direct drive monitors.

OPERATIONAL DESIGN

Quadcolor I operates in two fundamental modes: text and graphics. Within each of these modes are several possible display variations. (All modes are completely compatible with any software written to interface to the IBM PC color graphics adapter.)

Text mode allows the display of text characters in a 25 row by 80 column or 25 row by 40 column screen format. Each character can have its foreground color and background color determined independently. Additionally, characters may be blinked on an individual basis. You can select one of sixteen colors for foreground dots and one of eight colors for background dots.

There are two graphics modes available on Quadcolor I. The first is a medium resolution mode that is 320 pixels horizontally by 200 lines vertically. Each pixel can be one of four colors selected from one of two palettes. One of the four possible colors is the background color, which can be selected from any of sixteen colors. The remaining three colors depend on which of two palettes is selected. Selection of one palette gives the colors red, green, and brown; while selection of the second palette gives cyan, magenta, and white.

The second graphics mode is a high resolution mode which has a 640 pixel horizontal by 200 pixel vertical resolution in black-and-white. When a pixel is ON it is white and when it is OFF it is black. The ON color and the OFF color of each pixel can be changed to any one of sixteen colors. This allows true two color selection in high resolution mode.

MAJOR BLOCK DEFINITIONS

The major functional blocks of Quadcolor I are described in brief detail in the following paragraphs. More detail on some of the blocks is given in the Technical Reference section.

6845 CRT Controller

The CRT controller is a Motorola 6845 IC. It provides all the addressing of the video memory for display purposes as well as the video signals required for a standard raster scan display. The IC is highly programmable and provides for cursor control and a light pen interface as well as complete programmability for most display parameters.

I/O Registers

The I/O Registers program various control lines to set-up the various text and graphic modes. Additionally, the border colors in text mode and the background color in high resolution mode are set at I/O port registers. Two I/O port addresses are decoded to allow control of the light pen interface latch. A status register is also available to read horizontal sync, vertical sync, and light pen information.

Display Buffer

Quadcolor I contains 32K bytes of memory for display purposes. The display buffer occupies memory locations B8000H to BFFFFH. It is implemented as dual ported memory to allow equal access by the CPU and the CRT controller at all times. The format of the stored data is defined differently depending on the display mode selected.

Character Generator

In Text mode ASCII character codes and attribute bytes are stored in the display buffer. When the ASCII character code is read out of display memory it is used, with three ROW ADDRESS lines (RA0-RA2) out of the 6845 CRT controller, to form an eleven bit address to the character generator EPROM. The data outputs of the character generator then become the eight dot pattern for that particular ASCII code.

The character generator is a 2716 (single voltage) type EPROM. It contains the bit patterns for 256 characters. These include the standard 96 ASCII character set as well as 16 characters for the game port, 15 characters for editing purposes, 48 characters for foreign languages, 48 characters for business block graphics, 16 Greek characters, and 15 scientific notation characters.

Characters are defined in an 8x8 matrix and are formed in a 7x7 double dot format. This allows a one row descender for the characters that have tails. Information is provided in the Technical Reference section to allow you to program your own character set EPROM.

By cutting a trace and soldering a jumper, you can use a 2732 or 2764 type EPROM. Replacing the 2716 allows you to define a character set with more than eight scan lines per character (with a 2732), two character sets with eight scan lines per character (with a 2732) or two character sets with more than eight scan lines per character (with a 2764). When using a 2732 or 2764, a software controllable "Character Set Select" line is used to select which character set is being used.

Timing Generator

All timing signals are generated in this functional block. These signals include memory address mux signals, memory address strobes, character clocks, shift register loading, shifting clocks, and the color burst frequency (3.58 MHz).

Wait State Generator

The Wait State Generator serves to synchronize the CPU's accessing of display memory to prevent glitches on the screen caused by address and data bus contention problems between the 6845 CRT controller and the CPU. One, two, or three Wait States (210 ns, 420 ns, 630 ns delays) will be asserted every time the CPU accesses display memory.

Composite Color Generator

Quadcolor I provides a composite signal to drive a composite monitor (Black-and-White or color) or to drive an RF modulator connected to a standard TV. The inputs to the composite color generator are the same signals that appear on the direct drive connector. Horizontal sync, vertical sync, and the four color signals (I, R, G and B) are combined into a single base band analog composite video signal. This signal is a NTSC (National Television Standards Commission) composite signal that varies from 0 volts to about 1.5 volts. It will drive most composite monitors designed for use in the U.S. since they are specifically designed to be driven by an NTSC compatible signal.

Address Decoders

Quadcolor I's memory occupies 32K bytes of the IBM PC's memory space starting at B8000H. The upper five address lines (A15-A19) are decoded to create a "Memory Select" signal. Quadcolor I/O ports occupy the sixteen locations from 3D0H to 3DFH. Selection of this sixteen byte block is accomplished by decoding address lines A4-A9.

MODES OF OPERATION

Quadcolor I, like the IBM Color Graphics Adapter, has two basic modes of operation: text and graphics. For each of these two modes there are variations.

Text mode allows the display of 25 rows by 40 columns or 25 rows by 80 columns of text with multiple pages. Two resolutions may be selected in graphic modes: 320 x 200 (medium resolution) or 640 x 200 (high resolution). These modes are explained in more detail in the following sections.

Text

Text characters are stored as 8 bit extended ASCII codes (ASCII characters are normally 7 bits long to give a possible 128 character codes, but an eight bit code is accepted by the IBM PC to give an additional 128 codes). Each character on the screen requires two bytes of storage in the display buffer. The first byte is the 8-bit ASCII character code (0-255) while the second byte is the attribute byte. The attribute byte is used to define the character's foreground color, background color, and whether or not it blinks. A character's code must be stored at an even address while its attribute byte must be stored at the succeeding odd address. The complete 256 character set is shown in Table 1.

DECIMAL VALUE	HEX (DECIMAL VALUE)	0	16	32	48	64	80	96	112	128	144	160	176	192	208	224	240	
0	0	BLANK (NULL)	▶	BLANK (SPACE)	0	@	P	·	p	€	E	á	▨	▨	▨	▨	∞	≡
1	1	☺	◀	!	1	A	Q	a	q	ü	Æ	í	▨	▨	▨	▨	β	+
2	2	☹	↑	"	2	B	R	b	r	é	FE	ó	▨	▨	▨	▨	γ	≥
3	3	♥	!!	#	3	C	S	c	s	â	ô	û	▨	▨	▨	▨	π	≤
4	4	♦	¶	\$	4	D	T	d	t	ä	ö	ñ	▨	▨	▨	▨	Σ	∫
5	5	♣	§	%	5	E	U	e	u	ã	õ	Ñ	▨	▨	▨	▨	σ	∫
6	6	♠	■	&	6	F	V	f	v	â	û	á	▨	▨	▨	▨	μ	÷
7	7	•	↓	'	7	G	W	g	w	ç	ù	o	▨	▨	▨	▨	τ	≈
8	8	●	↑	(8	H	X	h	x	ê	ÿ	ï	▨	▨	▨	▨	Φ	°
9	9	○	↓)	9	I	Y	i	y	ë	Ö	Γ	▨	▨	▨	▨	⊕	•
10	A	◉	→	*	:	J	Z	j	x	è	Ü	⌈	▨	▨	▨	▨	Ω	•
11	B	♂	←	+	;	K	I	k	l	ì	ç	½	▨	▨	▨	▨	δ	√
12	C	♀	└	,	<	L	\	l	l	î	ℓ	¼	▨	▨	▨	▨	∞	η
13	D	♪	↔	-	=	M	I	m	l	ï	ÿ	ï	▨	▨	▨	▨	∅	²
14	E	♫	▲	.	>	N	^	n	~	Ä	Pts	«	▨	▨	▨	▨	Ε	■
15	F	⊙	▼	/	?	O	_	o	Δ	Å	f	»	▨	▨	▨	▨	∩	BLANK

Table 1: 256 Character Set

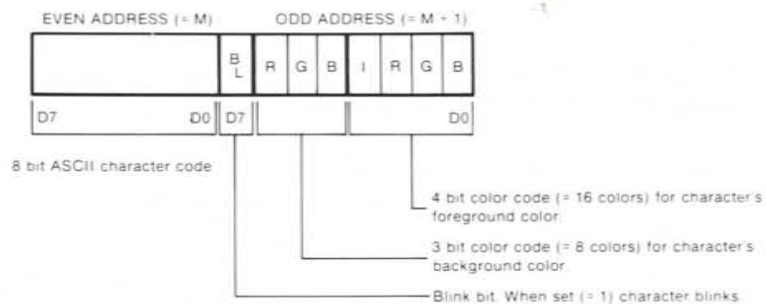

Table 2: Text Memory Allotment

Table 3: Summary of Available Colors				
I	R	G	B	color
0	0	0	0	black
0	0	0	1	blue
0	0	1	0	green
0	0	1	1	cyan
0	1	0	0	red
0	1	0	1	magenta
0	1	1	0	brown
0	1	1	1	white
1	0	0	0	gray
1	0	0	1	light blue
1	0	1	0	light green
1	0	1	1	light cyan
1	1	0	0	light red
1	1	0	1	light magenta
1	1	1	0	yellow
1	1	1	1	high intensity white

NOTE: If you are using a direct drive monitor that only accepts RGB inputs, you will be limited to eight colors instead of sixteen.

The Blink bit (D7) in the attribute byte may be redefined to be the character's background Intensity bit. This allows the choice of sixteen background colors but no blinking. The Blink bit is redefined by setting bit 5 low (0) in the Mode Select register.

Text Mode is the default mode for the IBM PC. Eighty or forty columns of text can be displayed while in text mode. The number of column rows is selected while in BASIC with the WIDTH statement and in DOS with the Mode command.

When forty columns are displayed, 1,000 characters can be put on the screen. Since every displayed character uses two bytes for storage, 2,000 memory locations are required to display a full screen. The 16K bytes of IBM compatible memory on Quadcolor I allows up to eight pages of 40 column text to be stored in the display memory at one time. Similarly, up to four pages of 80 column text may reside in the 16K bytes of IBM compatible memory.

The various pages are selected as parameters in the BASIC SCREEN command. Each 40 column text page starts on an even 0800H (2K) page boundary while each 80 column page starts on an even 1000H (4K) page boundary.

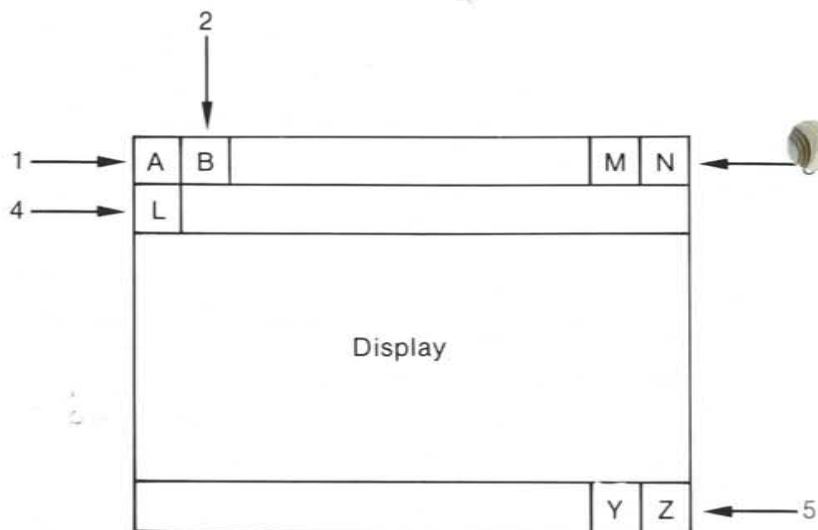

- 1 - B8000H = 41H
B8001H = attribute for "A"
- 2 - B8002H = 42H
B8003H = attribute byte for "B"
- 3 - B809EH = 4EH
B809FH = attribute byte for "N"
- 4 - B80A0H = 4CH
B80A1H = attribute byte for "L"
- 5 - B8F9E = 5AH
B8F9F = attribute byte for "Z"

Table 4: Memory mapping for the first page of display memory in 80 column mode

Medium Resolution Graphics

Medium resolution graphics mode has a resolution of 320 pixels horizontally by 200 pixels vertically. Each pixel can be one of four colors selected from one of two palettes. Two bits are used to control the four colors. The pixels in each byte are formatted as follows:

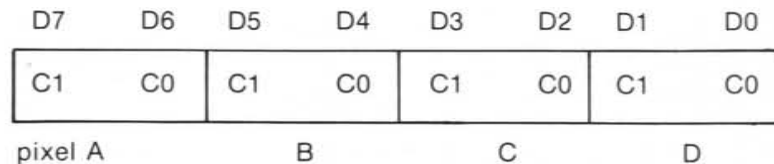

Figure 5: Medium resolution pixel format

Pixel A will be to the left of pixel B which will be to the left of pixel C and so on. Colors are selected according to the following table:

C1	C0	
0	0	Selects one of sixteen background colors
0	1	Selects color #1 from set 1 or 2
1	0	Selects color #2 from set 1 or 2
1	1	Selects color #3 from set 1 or 2

Table 5: Color Table

The two color sets are:

Set 1	Set 2
Color 1 - Cyan	Color 1 - Green
Color 2 - Magenta	Color 2 - Red
Color 3 - White	Color 3 - Brown

Table 6: Medium resolution color sets

Medium resolution requires 16,000 bytes of display memory. Even numbered horizontal lines (0,2,4,6,...) are stored in the first 8,000 bytes of display memory starting at B8000H; odd numbered horizontal lines are stored in the 8,000 bytes starting at BA000H. Address B8000H contains the first four pixels starting at the upper left corner of the screen.

Table 7: Medium resolution graphics storage map:



High Resolution Graphics

High resolution graphics mode allows for the display of 640 pixels horizontally by 200 lines vertically. Only two colors are displayed in this mode: black when a pixel is off and white when a pixel is on. The "Tips and Techniques" section of this manual explains how to program any of sixteen "OFF" colors and any of sixteen "ON" colors in this mode. Each pixel is controlled by a single bit in memory; thus, each byte of display memory controls eight pixels. The byte storage format is:

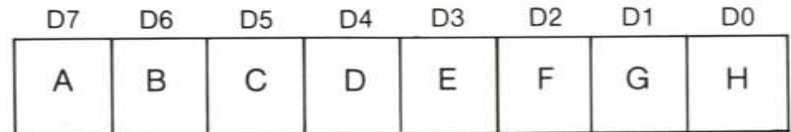

Figure 6: High resolution pixel format

Pixel A will appear to the left of pixel B which will be to the left of pixel C and so on. If a bit is on or equal to 1 the corresponding pixel will appear white. Conversely, if the bit is off or equal to 0, the pixel will be black (unless the "ON" and "OFF" colors have been changed as mentioned above). High resolution requires 16,000 bytes of display memory. Memory storage is similar to that used in medium resolution mode. Even numbered lines are stored in the first 8000 bytes of display memory while odd numbered lines are stored in the 8,000 bytes starting at the second 8K of display memory.

6845 CRT Controller

As mentioned earlier, the 6845 is highly programmable. It contains 19 internal registers. One register, the Address register, is used to point to one of the other 18 registers. This is a write-only register occupying I/O address 3D4H. Programming a 6845 register requires that the 5-bit address of the desired register first be loaded into the Address register.

After the Address register is loaded, the data for the desired register can be loaded by doing a Write to I/O address 3D5H. These are the addresses used by IBM software but the Address register actually will respond to any even I/O address from 3D0H to 3D7H (instead of 3D4H) while the data may be written to any odd I/O address between 3D0H and 3D7H (instead of 3D5H).

All of the programmable features of the 6845 cannot be discussed here. If you need more information about this IC, refer to Motorola's Microprocessors Data Manual or Hitachi's Microcomputer Data Book. Table 8 shows the parameters used to program the 6845 in text and graphics modes.

6845 Register Description

ADDR REG.	REG. #	REGISTER TYPE	UNITS	I/O	40x25 ALPHA	80x25 ALPHA	GRAPHIC MODE
0	R0	Horizontal Total	Char.	Write Only	38	71	38
1	R1	Horizontal Displayed	Char.	Write Only	28	50	28
2	R2	Horiz. Sync Position	Char.	Write Only	2D	5A	2D
3	R3	Horiz. Sync Width	Char.	Write Only	0A	0A	0A
4	R4	Vertical Total	Char. Row	Write Only	1F	6A	7F
5	R5	Vertical Total Adjust	Scan Line	Write Only	06	06	06
6	R6	Vertical Displayed	Char. Row	Write Only	19	64	64
7	R7	Vert. Sync Position	Char. Row	Write Only	1C	67	70
8	R8	Interlace Mode	—	Write Only	02	02	02
9	R9	Max Scan Line Addr.	Scan Line	Write Only	07	01	01
A	R10	Cursor Start	Scan Line	Write Only	06	06	06
B	R11	Cursor End	Scan Line	Write Only	07	07	07
C	R12	Start Addr. (H)	—	Write Only	00	00	00
D	R13	Start Addr. (L)	—	Write Only	00	00	00
E	R14	Cursor Addr. (H)	—	Read/Write	XX	XX	XX
F	R15	Cursor Addr. (L)	—	Read/Write	XX	XX	XX
10	R16	Light Pen (H)	—	Read Only	XX	XX	XX
11	R17	Light Pen (L)	—	Read Only	XX	XX	XX

Note: All register values are given in hexadecimal.

Table 8: 6845 Program Parameters

Some of the 6845 registers have unspecified values (xx) in them. This indicates the register's contents will change depending upon the software that is currently running. The contents of the Cursor Register will change as the cursor is moved about on the screen. The Light Pen register's contents will depend upon when the light pen is activated (if one is connected at all). Additionally, the starting address register contents will change depending upon which page is currently being displayed.

Mode Control Register

The Mode Control Register is a 6-bit write-only I/O port. It is used to set up the rest of the Quadcolor I circuitry for the text and graphics modes. The operation of this I/O port is identical to the same port used on the IBM Color Graphics Adapter. The following lists the function of the bits and a short description of each bit's operation follows.

D0	80-column Select
D1	Graphics Select
D2	B & W Select
D3	Enable Video Signal
D4	HiRes Select
D5	Enable Blink
D6	Not used
D7	Not used

D0 selects between 40 and 80 column text mode. A "1" selects 80 column.

D1 selects text or graphics modes. A "1" selects graphics mode.

D2 is used to disable color on the composite signal (i.e. enable black-and-white). A "1" selects black-and-white display. This is accomplished by only allowing ON or OFF (DC levels) for the video signal rather than the required color phase information. It also disables the color burst reference signal.

D3 enables video. When set to "0" the display is blanked. IBM recommends disabling video when changing modes.

D4 selects the medium resolution (320 x 200) or high resolution (640 x 200) graphics modes. When set to "1" high resolution mode is selected.

D5 defines the Most Significant Bit (D7) of the attribute byte in text mode. A "1" will define the attribute byte's MSB as a Blink attribute; if D7 equals "1" the character will blink and if D7 does not equal "1" it will not blink. If the Enable Blink bit is low the MSB of the attribute byte becomes the intensity bit for the background colors. Thus you can have 16 background colors and no blinking.

The following lists the contents of the Mode Control register for the various operating modes.

	5	4	3	2	1	0	
	1	0	1	1	0	0	40 x 25 Text B & W
	1	0	1	0	0	0	40 x 25 Text Color
	1	0	1	1	0	1	80 x 25 Text B & W
	1	0	1	0	0	1	80 x 25 Text Color
	2	0	1	1	1	0	320 x 200 Graphics B & W
	2	0	1	0	1	0	320 x 200 Graphics Color
	2	1	1	1	1	0	640 x 200 Graphics B & W

Table 9: Contents of the Mode Control Register

Color Select Register

The Color Select Register is a 6-bit write only I/O port. It is used to set up the Border color in text mode (which is also the Background color in medium resolution mode); select the palette in medium resolution mode; and select an intensified set of colors in medium resolution mode. This port also operates identically to the same port on the IBM Color Graphics Adapter. The following table lists the function of the bits followed by a short description of their operation.

D0	Overscan Blue
D1	Overscan Green
D2	Overscan Red
D3	Overscan Intensity
D4	Medium Resolution Intensity
D5	Palette Select
D6	Not used
D7	Not used

In Text mode D0 - D3 select one of sixteen border colors. In medium resolution mode they select one of sixteen colors to be used as the background color (i.e., when color 0 is selected). On direct drive monitors one of sixteen foreground colors in high resolution mode may be selected by storing the 4 bit value here.

D4, when set to "1," will intensify the colors ordinarily selected in medium resolution graphics mode. It will only intensify color 1, 2, and 3; it will not intensify the background color since it has its own intensity bit. This bit is normally set to 0 by IBM software.

D5 controls the choice of palettes in medium resolution mode. When set to "0," palette 0 (Green, Red, Brown) is selected; when set to "1," palette 1 is selected (Cyan, Magenta, and White).

Status Register

The Status register is a 4-bit read-only I/O port at address 3DAH. It is used to read some of the video timing information as well as inputs from a light pen (if one is connected). The following table gives the status read at each bit and follows with a brief description of each bit's operation. This port is identical in operation to the one found on IBM's Color Graphics Adapter.

D0	Display Enable
D1	Light Pen Strobe
D2	Light Pen Switch
D3	Vertical Sync
D4	Not used
D5	Not used
D6	Not used
D7	Not used

D0, monitors the Display Enable line from the 6845 to indicate when active video is being displayed. This is included for software compatibility with the IBM PC. When operating IBM's Color Graphics Adapter in 80 column text mode, the display memory cannot be accessed during the active video periods without causing address and data bus conflicts with the CRT controller timing and causing glitches on the screen.

D1, when high ("1"), indicates an output from the light pen. This bit is the output of a flip-flop that can be set via port 3DCH or reset via port 3DBH.

D2, when low ("0"), indicates the light pen switch is closed and may need servicing.

D3 when high ("1") indicates that a vertical retrace is occurring. It is recommended that modes only be changed during vertical retrace to smooth out the display operation.

To overcome this problem, the IBM display driver routines wait for a transition (low to high) on the Display Enable line before accessing display memory for a few characters. Quadcolor I does not have this problem and memory may be accessed at any time in any mode. This allows much faster accessing of display memory (which means faster screen updating).

Unfortunately, a lot of software written for the IBM PC uses IBM's driver for accessing display memory, and this software needs to see the Display Enable transitions. Display Enable is essentially a horizontal sync signal and has a period of 63.5 microseconds. The active video period is about 45 microseconds while the remainder is inactive video (essentially horizontal retrace).

Clear Light Pen Strobe

This is not an actual I/O port. This is a decoded address (3DBH) that is used to clear a flip-flop that has been set by an input from the light pen. Reading or writing to this I/O port address will clear the flip-flop. The data is irrelevant.

Set Light Pen Strobe

The operation of this I/O port (address 3DCH) is similar to the Clear Light Pen Strobe described above. It is used to set the light pen input flip-flop. Reading or writing to this I/O port is sufficient to set the flip-flop. Data is irrelevant. Setting this flip-flop will prevent light pen input transitions from being sent to the 6845 light pen strobe input.

Quadcolor I Register

This is a 6-bit write-only I/O register whose address is 3DDH. It is used to control the enhanced features of Quadcolor I and is not compatible with any similar register on the IBM Color Graphics Adapter (since the IBM card doesn't have the Quadcolor I enhancements). Functions that are controlled by this register include selection of one of sixteen background colors (for direct drive monitors) in high resolution graphics mode, selection of the lower 16K bank of memory (IBM compatible) or the upper 16K bank (Quadcolor enhancement) and selection of one of two character sets in EPROM. The outputs of this register are all reset to 0 at power-up. IBM software will never address this I/O location so that any nonzero data written to this port will remain there until rewritten (to zero) or until another power-on reset occurs.

In some cases, it may be necessary to reset a bit (or bits) to zero before changing display modes.

For instance, if the upper 16K bank of memory is selected to display a user-generated display, when the program is stopped the text output by IBM's BASIC will continue to be loaded into the lower 16K of memory and will not be seen as long as the upper 16K bank is selected for display.

Be aware of this during debugging. The following lists the port's bits and is followed by a description of their operation and use.

D0	HiRes Blue
D1	HiRes Green
D2	HiRes Red
D3	HiRes Intensity
D4	Bank Select
D5	Character Set Select
D6	Not used
D7	Not used

D0 - D3 allows for the choice of one of sixteen background colors in high resolution graphics mode for display on a direct drive color monitor. By setting a background color via the lower 4 bits of this register, the high resolution graphics mode can indeed display true, two color graphics instead of being limited to just black and white.

D4 is the Bank Select line and selects which of the two 16K byte banks of memory is to be displayed. Setting this bit to "1" selects the upper 16K bank starting at address BC000H. A "0" selects the lower 16K bank (IBM compatible) starting at B8000H.

D5 allows selection of character sets when a 2732 or 2764 EPROM character generator with two character sets is installed. When a 2716 type EPROM is installed, this line has no effect. A "0" will select the character set stored in the lower half of a 2732 or 2764, while a "1" will select the character set in the upper half of the EPROM. See the section discussing the EPROM for more information about changing character sets.

Character Generator

Quadcolor I uses a 2716 type EPROM as a character generator. Characters are formed in a 7x7 dot matrix with one descender. The character box is 8x8 with the right-most column usually blank for text characters. A graphics character may use the whole 8x8 box. There are 256 characters stored in the character generator. They are compatible with those of IBM's Color Graphics Adapter.

Each character code pattern stored in the EPROM requires eight bytes. The starting location for each ASCII character code's bit pattern may be determined by multiplying the character code by eight. Thus, a capital "A" bit pattern (ASCII character code 41H) would start at location 208H and continue to 20FH (=8bytes). The storage order for the eight bytes is as follows: the first byte describes the top row of dots for the character while the eighth byte describes the bottom row. The most significant bit (D7) of a byte corresponds to the left (or first) column in a character. The least significant bit (D0) corresponds to the eighth column. Shown in Table 10 is the dot pattern for a capital "A" and the memory locations and corresponding contents.

Location	D7	D6	D5	D4	D3	D2	D1	D0	Contents
208H			■						30H
209H		■	■	■					78H
20AH	■			■	■				CCH
20BH	■			■	■				CCH
20CH	■			■	■				FCH
20DH	■			■	■				CCH
20EH	■			■	■				CCH
20FH									00H

Table 10: IBM "A" Dot Pattern

You have the option of changing the character set by installing a 2732 (4K) or 2764 (8K EPROM).

If changing to a 2764, the 24 pin DIP socket will have to be replaced with a 28 pin DIP socket. Be sure each pin is free before lifting the socket out of the board, as a trace that is still soldered to the board could be pulled up.

Several programming options exist when changing EPROMs. A 2732 can be programmed to contain two 256-character sets with each character made up of eight scan lines/ character or with a single character set with characters made up of more than eight scan lines (but less than sixteen). A 2764 can be programmed to contain two 256-character sets with characters made up of as many as sixteen scan lines.

When changing from a 2716 to a 2732 or a 2764 EPROM, J6 — which is just below the EPROM socket — must be programmed. The pin numbers for J6 are shown below.

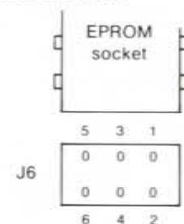

Figure 7: Pin Numbers for J6

The following figure shows the connections to J6 and the selection options that are available.

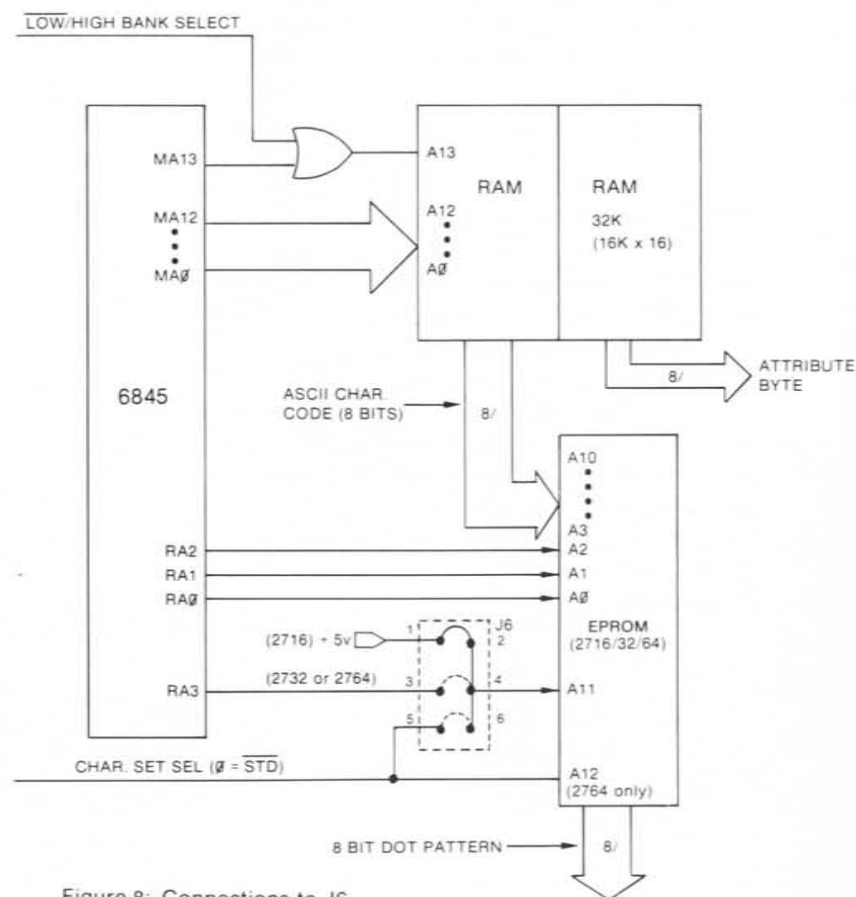

Figure 8: Connections to J6

A trace (located on the noncomponent side of the board) connecting pins 1 and 2 is part of the standard Quadcolor I board layout. This is the connection for the standard 2716 EPROM character generator provided with Quadcolor I. When using a 2732 or a 2764, this trace must be cut before making any other connections. The trace may be cut with a hobbyists knife or a razor blade. A jumper may be installed across pins 1 and 2 if you decide to switch back to a 2716 at a later date.

A 2732 may be programmed for two character sets or a single character set with up to 16 scan lines per character. When programming for two sets of characters with eight scan lines per character, one character set should be located starting at 000H and the second character set should be located starting at 800H. The eight bytes for each character should be stored in consecutive locations starting at the location that is equal to eight times the character code (as described at the beginning of this section). A jumper needs to be installed across pins 5 and 6 on J6 to connect the Character Set Select Line to the most significant address line (A11) of the EPROM. The character set select line is set to 0 upon a power-up or reset. Thus the standard character set should be located in the lower 2K (starting at 000H) of the 2732. The alternate character set is selected by setting the Character Set Select Line to 1 (see the description of the Quadcolor I register in "Programming Considerations").

If a single character set with more than eight scan lines for characters is to be used, a jumper needs to be installed across pins 3 and 4 of J6. This connects the fourth Row Address line out of the 6845 to the 2732's most significant address line, A11. When using a character set with more than eight scan lines per character, the 6845 will have to be reprogrammed. The storage order for the bytes containing the character dot patterns is a little bit different than that for eight scan lines per character.

The first eight (top eight) scan lines for each character should be stored at the location that is eight times the character code. The storage addresses for the remaining bytes are calculated in a manner similar to that for the first eight scan lines, except that an offset of 800H (2K) is added to the calculated address to locate the additional bytes in the upper 2K of the 2732 EPROM's address space. An example should demonstrate the storage scheme for a capital "A" in an 8x10 format.

Table 11: Custom "A" Dot Pattern

Location	ASCII CODE = 41H								8 x 41H = 208H								Content
	D7								D0								
208H																	10H
209H																	38H
20AH																	6CH
20BH																	C6H
20CH																	C6H
20DH																	FEH
20EH																	C6H
20FH																	C6H
(800H + 208H) = A08H																	C6H
(800H + 209H) = A09H																	00H

The locations A0AH through A0FH are just wasted since the 6845 will only be programmed for 10 scan lines per character. If 16 scan lines per character was programmed in the 6845 then locations A0AH through A0FH would contain the dot patterns for the 11th through 16th scan lines.

Using a 2764 EPROM is similar to using a 2732 except that two character sets with up to sixteen scan lines per character can be programmed into it. A jumper must be installed across pins 3 and 4 of J6. The dot patterns for the first eight scan lines of the standard character set occupy the first 2K bytes (0000H through 07FFH) of the 2764's memory. The ninth through the sixteenth scan line bytes of the standard character set are stored in the second 2K block (0800H through 0FFFH). The first eight scan lines for the alternate character set are stored in the third 2K block (1000H through 17FFH) while the ninth through sixteenth scan line dot patterns are stored in the fourth 2K block (1800H-1FFFH). The character sets are selected the same way as that described for the 2732. The Character Set Select Line is set to 0 (the power-up default value) to select the standard set and to a 1 to select the alternate character set.

TIPS & TECHNIQUES

Animation

Some low-level animation can be implemented with the Quadcolor I using the two banks of memory. The original "frame" is created in one 16K bank of memory and this bank is selected using the Bank Select line (D4 of I/O port 3DDH). The next "frame" is created in the other 16K (the nondisplayed 16K). This second frame, and succeeding frames, will usually be only slightly different from the preceding frames, and can be very quickly updated by only changing the portion of the scene that is different.

The animation is achieved by updating the undisplayed memory bank, switching to it, updating the other bank of memory (now undisplayed), switching to it, and so on. For a smooth display, the banks should be switched during the vertical retrace period. Animation can also be better achieved by writing your program in assembly language rather than BASIC because of the speed that is usually required.

Alternate Bank Selection Technique

Instead of using the Bank Select I/O line to select a bank of memory, the starting display address stored in the 6845 can be programmed to a value of 2000H to select the upper 16K bank of memory. A starting address of 0000H, of course, selects the lower 16K bank (the default bank on power-up or reset). When using the starting address register in the 6845 for bank selection the Bank Select line must be set to 0. By the same token, when using the Bank Select line for bank switching, the starting address should be programmed to 0000H (or some value less than 2000H to keep the 6845's MA13 address line low).

Fast Memory Accessing

IBM's Color Graphics Adapter is designed such that, when operating in 80 column text mode, if the display memory is accessed at any other time during horizontal retrace, glitches will appear on the screen due to memory contention problems between the 6845 CRT controller and the PC's 8088 CPU.

To prevent glitches on the screen, IBM's video driver is written so that the display memory is accessed only during the horizontal retrace period. This slows down screen updating considerably.

Quadcolor I does not have the CRT-CPU contention problem that IBM has and display memory can be accessed at any time without causing glitches on the screen. When writing to or reading from display memory, the IBM video driver software should not be used. Rather, the user's software should directly write to (or read from) the display memory or replace the IBM video driver.

J5 Description

When Quadcolor I is used by itself (without Quadcolor II) four shorting jumpers are installed between four pins of J5 and J6. The purpose of these four jumpers is to ground what would be the four color inputs, (I, R, G, B) from Quadcolor II. Each of the four color outputs from Quadcolor I is OR'ed with the four color outputs from Quadcolor II. This allows the video from each board to be displayed together, or overlaid.

When Quadcolor II is not installed, the pins that would carry the color signals from the Quadcolor II need to be grounded.

The four pins of J5 are connected to Ground and when the shorting jumpers are installed pins 7, 9, 11, and 13 of J3 are grounded. When one of these jumpers is removed the input to its respective OR gate will "float" and cause that color to be "ON" all the time. The pin assignments are shown below. Removing any jumper will cause that color to be on all the time.

Figure 9: J3 pin assignments

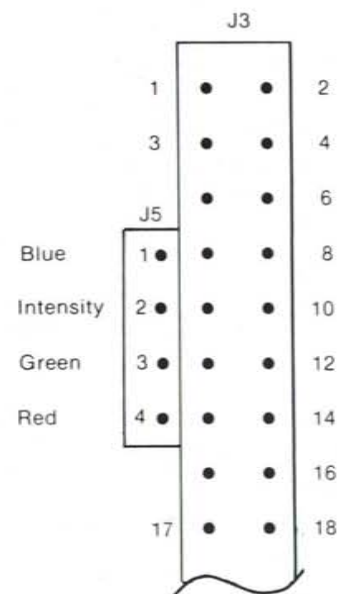

Alternate Character Set Uses

Alternate character sets may be used to advantage in many different applications. Some of these applications are listed below.

- 1) An alternate 256 block and line graphics character set can be created as the alternate set of characters.
- 2) Special characters can be created for game software packages.
- 3) Large characters can be created by programming their parts as characters. For instance, a large card suit character (e.g. a heart) can be created by programming each quarter of the large character as a regular character.

Third Medium Resolution Palette

A third palette is available in medium resolution mode (screen 1) which is a modified version of the second palette. This palette is available by selecting the second palette (with colors cyan, magenta, and white) and setting bit 2 of I/O port 3D8H to a 1. This changes the palette color definition to:

Color 1 - Cyan
Color 2 - Red
Color 3 - White

This will only work on direct drive monitors. Additionally, colors 1, 2, and 3 can all be brightened (or Intensified) by setting bit 4 of I/O port 3D9H to a "1."

IBM Technical Reference Manual

All material in the IBM Technical Reference Manual concerning the IBM Color Graphics Adapter is applicable to Quadcolor I except:

- 1) Schematic
- 2) Memory accessing in 80-column mode
- 3) Amount of memory, bank switching
- 4) Expandability
- 5) Character generator programmability; character set selection.

Bank Swapping

As mentioned earlier, there are two 16K banks of memory on the Quadcolor I board. The contents of either bank may be selected for display by setting or resetting bit D4 of I/O port 3DDH. When this bit is set to a 0 (the power-up default value) the lower 16K bank starting at location B8000H is selected for display; a "1" selects the upper 16K bank starting at BC000H.

IBM's BASIC does not support the upper 16K bank of memory and the user must load the contents of this bank by accessing the memory directly rather than with any high level commands such as DRAW, PAINT, etc. The user must understand the format of data storage for each of the screen modes to be able to get an image into the upper bank of memory. This information is addressed earlier.

Loading an image into the upper 16K bank is relatively easy and fast when programming in assembly language or a compiled high level language. But in Interpreted BASIC the only commands for accessing the upper bank are PEEK and POKE commands. The slowest method for creating an image in the upper bank is to ignore all the built in graphics commands of BASIC and calculate each of the 16000 points and store them at the appropriate locations in the upper bank. This can be tedious and time consuming to say the least.

An easier way is to create the desired image in the lower 16K bank using the built-in graphic commands of BASIC. When the image is completed, it can be moved to the upper bank of memory by one of two methods.

The first method is to simply copy the contents of the lower bank to the upper bank, a byte at a time, using the PEEK and POKE statements. While admittedly slow, this method is faster than the previously mentioned way in that no calculations have to be made for each display point. It becomes a simple case of copying the contents of one memory area to another.

Luckily BASIC does have a means of quickly moving the contents of one memory area to disk, and another means for quickly moving the stored memory contents from disk to another memory area. These two BASIC commands are BLOAD and BSAVE. BSAVE will move the contents of memory

ADDENDA

Please substitute the following command lines for those given on page 45 of the Quadcolor I Operations Manual (Part No. 9520):

10 SCREEN 1

20 'Lines 20-200 draw the desired image in the
'lower 16K bank using standard BASIC
'graphics commands.

210 DEF SEG=&HB800 'Memory accessing will be
'relative to B8000H, the
'beginning of the lower
'bank of memory.

220 BSAVE "PICTURE",0,&H4000
'Store in file "Picture" starting at B8000H (0
'offset); store 16K bytes (= &H4000).

230 BLOAD "PICTURE",&H4000
'Bring file ("Picture") back into memory
'starting at beginning of upper bank
'(BC000H=B8000H + 4000H).

240 OUT &H3DD,&H10 'Enable upper bank to see
'image in upper bank.

250 OUT &H3DD,0 'Switch back to lower bank.

(Quadram Part No. 12-9520-04)

ADDENDA

Please substitute the following command lines for those given on page 45 of the Quadcolor I Operations Manual (Part No. 9520):

10 SCREEN 1

```
20 'Lines 20-200 draw the desired image in the
    'lower 16K bank using standard BASIC
    'graphics commands.

210 DEF SEG=&HB800 'Memory accessing will be
    'relative to B8000H, the
    'beginning of the lower
    'bank of memory.

220 BSAVE "PICTURE",0,&H4000
    'Store in file "Picture" starting at B8000H (0
    'offset); store 16K bytes (= &H4000).

230 BLOAD "PICTURE",&H4000
    'Bring file ("Picture") back into memory
    'starting at beginning of upper bank
    '(BC000H=B8000H + 4000H).

240 OUT &H3DD,&H10 'Enable upper bank to see
    'image in upper bank.

250 OUT &H3DD,0 'Switch back to lower bank.
```

(Quadram Part No. 12-9520-04

to a disk file while BLOAD will move the file contents back to a different memory area. These two commands are explained in the BASIC manual and an example of their use is given below.

10 SCREEN 1

```
20 'Lines 20-200 draw the desired image in the
    'lower 16K bank using standard BASIC
    'graphic commands.

200
210 DEF SEG=@HB800 'Memory accessing will be
    'relative to B8000H, the
    'beginning of the lower
    'bank of memory.

220 BSAVE "PICTURE",0,@H4000
    'Store in file "Picture" starting at B8000H (=0
    'offset); store 16K (= &H4000) bytes.

230 BLOAD "PICTURE",@H4000
    'Bring file ("Picture") back into memory
    'starting at beginning of upper bank
    '(BC000H=B8000H + 4000H)

240 OUT @H3DD,@H10 'Enable upper bank to see
    'image in upper bank.

250 OUT @H3DD,0 'Switch back to lower bank.
```

Of course, if you have a RAM Disk of some sort, where a disk drive is emulated in memory, you should store and retrieve the image file to and from the RAM disk for faster accessing.

There is nothing that says the full 16K block has to be moved nor is there anything that says that the offset has to be 0. Also, if copying a screen 0 image only 4K (80-column) or 2K (40-column) bytes of memory needs to be copied since less memory is used to fill a screen in text mode.

INTERFERENCE STATEMENT:

This equipment has been certified to comply with the limits for a class B computing device, pursuant to subpart J of part 15 of FCC rules. Only peripherals (computer input/output devices, terminals, printers, etc.) certified to comply with the class B limits may be attached to this computer. Operation with non-certified peripherals is likely to result in interference to radio and TV reception. This equipment generates and uses radio frequency energy and if not installed and used in strict accordance with the manufacturer's instructions, may cause interference to radio and television reception. It has been type tested and found to comply with the limits for a class B computing device in accordance with the specifications in subpart J of part 15 of FCC rules, which are designed to provide reasonable protection against such interference in a residential installation. However, there is no guarantee that interference will not occur in a particular installation. If this equipment does cause interference to radio or television reception which can be determined by turning the equipment off and on, the user is encouraged to try to correct the interference by one or more of the following measures:

- *Reorient the receiving antenna.
- *Relocate the computer with respect to the receiver.
- *Move the computer away from the receiver.
- *Plug the computer into a different outlet so that computer and receiver are on different branch circuits.

If necessary, the user should consult the dealer for additional suggestions. The user may find the following booklet prepared by the Federal Communications Commission helpful: "How to identify and resolve radio-TV interference problem". This booklet is available from the U.S. government printing office, Washington, DC 20402, stock no. 004-000-00343-4.

NOTES

Get more out of your Personal Computer system with these other fine Quadram Products



Quadboard

Quadram's Quadboard is a six-function expansion board for the IBM Personal Computer. It is designed to greatly increase the PC's capabilities for minimum cost while using only one internal expansion slot. The functions provided on this one board include: Random Access Memory (RAM) expansion from 64K to 384K bytes in 64K increments, an EIA RS-232C Serial Interface for asynchronous communications, a Centronics compatible parallel interface for printer driving, and a battery-powered Quartz clock/calendar to keep your PC's internal clock always on time, plus a game port.



Memory Expansion Board

Perfectly compatible with other peripheral cards, Quadram's Memory Expansion Board is designed to increase the random access memory capacity of the IBM Personal Computer in 64K byte increments up to 192K. The Memory Expansion board has been manufactured with performance and reliability in mind, and has been constructed of only high-quality material and components. Each board has been burned-in and thoroughly tested to insure many years of dependable service.

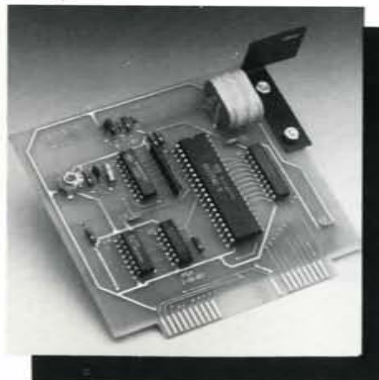

Clock/Calendar

The Clock/Calendar Card from Quadram Corporation is a small plug-in unit designed for the IBM Personal Computer. It provides an accurate crystal-controlled date/time keeping function which automatically sets the IBM DOS internal clock/calendar whenever DOS is booted from a diskette. The card is powered by a self-contained battery automatically recharged by the computer, and provides continuous time keeping even when the computer is off for long periods of time.

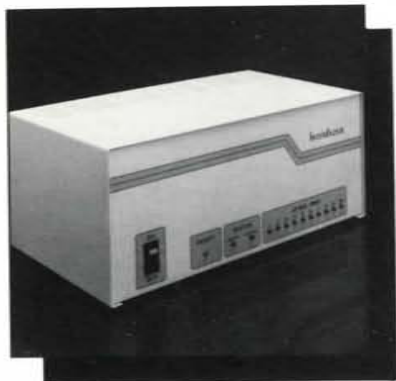

InterFazer

The InterFazer from the Quadram Corporation is an intelligent peripheral controller/buffer designed to provide interfacing and priority control for up to eight output devices feeding and sharing one or two input devices. The inputs and outputs may be in any combination of serial or parallel. The InterFazer's state-of-the-art design allows it to function as a multi-user printer controller, an incompatible device interface, a computer I/O expander, a peripheral multiplexer, a data transfer rate converter, and an additional peripheral buffer.

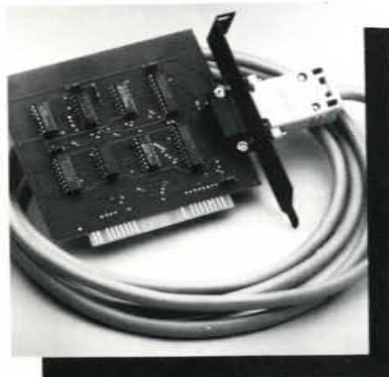

IPIC

Quadram's IPIC (IBM Parallel Interface Card) is a general purpose Centronics parallel interface card complete with cable for the IBM Personal Computer. It is specifically designed to drive printers, but may be used as an I/O driver for any parallel device that matches its input/output capabilities. The IPIC works exactly like IBM's Parallel Printer Adapter and supports the graphics function on many common graphics printers including IBM, Epson, Centronics, and others.

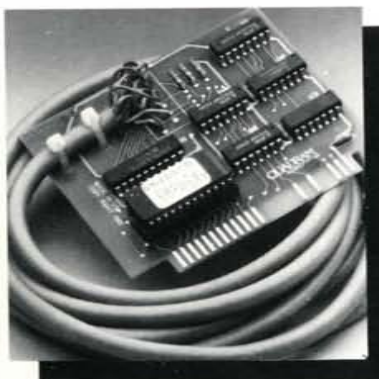

APIC Graphics

The Apple Parallel Interface Card is manufactured by the Quadram Corporation as a Centronics compatible parallel interface for the Apple II and Apple II+ computers. The card contains a graphics option. Both Apple Graphics pages can be printed from the screen with several simple commands.

APIC-G has many text features, including adjustable margins, page length, line length, and others. APIC-G is available for several types of printers.

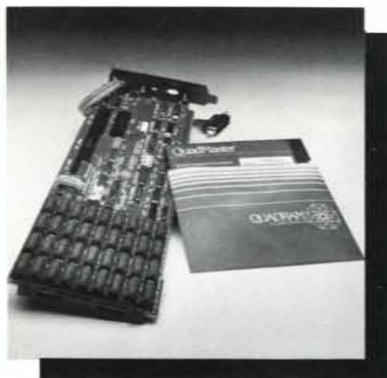

Quadboard II

Quadram's Quadboard II is an all-on-one board which combines six IBM PC functions in one. This multifunction board combines two serial ports, chronograph, memory expansion, RAM disk and spooler — all compatible with IBM PC hardware. The two RC-232 async ports can be used for modems, printers, and other serial devices. Memory expansion is socketed and fully expandable in 64K increments up to 256K. Full parity generation and checking are standard.

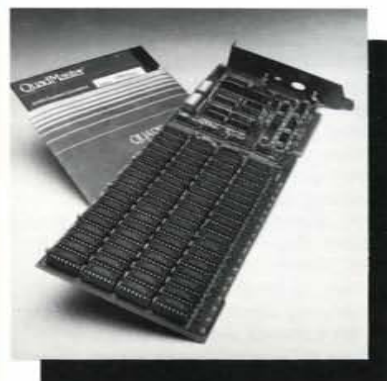

Quad 512+

Now IBM PC owners can enjoy faster computing times and more capabilities with the Quad 512+. This new board from Quadram combines memory expansion of 512K RAM in increments of 64K, 256K, or 512K; a serial port; RAM disk; and spooler. The RS-232 async serial port uses the same chip as the IBM serial board and is used for connecting modems, printers, and other serial devices. QuadMaster software with QuadRAM Drive and spooler is included.



Microfazer

The Quadram Microfazer is a universal print buffer with 8K to 512K RAM — the first with a half-megabyte! The Microfazer receives information in its memory, then sends it to the printer at an appropriate speed. The Microfazer comes with a copy feature allowing additional copies of the buffered information. The unit is sized to stack with popular modems and other peripherals; and some even plug directly into the printer!



Quadscreen

Quadscreen is a high-resolution (960 x 512), bit-mapped, "big-screen" monitor for the IBM Personal Computer. The large monochrome screen can display 10,240 characters — more than five times the screen capacity of IBM's PC monitor. Dot addressability, super spreadsheet, and split-screen functions are some of the distinctive elements of Quadscreen that maximize graphics capabilities and increase word processing efficiency. Quadscreen comes with monitor, connector cable, and a video card with 128K bytes of available RAM.

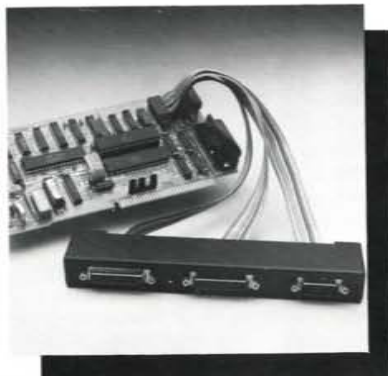

Quad I/O

Quadram's Quad I/O combines up to five of the most-needed IBM PC input/output devices onto one card. This multifunction board contains a parallel port designed to operate most printers and other parallel devices; a battery-powered chronograph — an extremely accurate real-time clock/calendar; a game port for game paddles, fire buttons, or joysticks; a serial port for connecting modems, printers, and other serial devices; plus an optional second serial port which can be ordered with the board or added at a later date.



Quadchrome

This is the perfect monitor for any data processing environment — Quadchrome by Quadram. Quadchrome is a high-resolution (690 x 240) RGB color monitor designed with an NEC .31 dot pitch cathode ray tube. The high resolution makes Quadchrome perfect for word processing, spreadsheet programs, and other common business applications. But Quadchrome also has amazing color capabilities. It's able to produce up to 16 different colors on the screen at once. This makes Quadchrome perfect for color graphics work, too.



Quadlink

Quadram introduces Quadlink, the revolutionary enhancement board that turns your IBM Personal Computer into an Apple-compatible system. Quadlink is an Apple-emulator that plugs into one of the PC's expansion slots. The board uses the same disk drive and I/O devices as the PC, working in complete harmony with the computer system. With Quadlink, no diskette reformatting is necessary. Just put the Apple diskette in the drive and watch it go.

Quadlink comes complete with printed circuit board and all the necessary cables for integrating the board into the system. Plus there's software for booting the Quadlink and running the Apple DOS 3.3 and thorough documentation explaining the installation and operation of the board.



Quadcolor I and II

Quadram presents Quadcolor, the most powerful color graphics adapter package available today. Quadcolor is perfectly compatible with the Personal Computer and XT and comes in two versions.

Quadcolor I has 32K of on-board RAM for up to 16 active video pages in text mode and two complete pages in graphics mode. Plus, you get a choice of two true colors in high-resolution mode with Quadcolor I.

Snap Quadcolor II onto Quadcolor I for 96K of RAM and choose from 136 different colors for ultra high-resolution bit-mapped graphics. Quadcolor II also comes with BASICQ, an enhanced graphics software package that's powerful and easy to use.

The Quadram Qlique (pronounced clique)

You're special to us . . .

As a Quadram product owner, you're very special to us. You've become a preferred customer. And as a preferred customer we want to keep you updated on what's happening at Quadram. That's why we want you in the Qlique (pronounced clique). The Quadram Qlique is a special membership of all our preferred customers. As a member in the Qlique you'll receive information on new product releases, general information about Quadram's complete line of microcomputer enhancements, plus free periodic software updates. It's a great way to "stay tuned" to what's happening at Quadram!

Joining the Qlique is easy . .

It's free! All you have to do is complete the attached card and mail it back to us. We'll put you on our membership list and make sure you stay up-to-date on the exciting things going on at Quadram.

C'mon. Get in tune. Join the Qlique by sending in the card today.