

Quadboard Operation Manual



4355 International Blvd. / Norcross, Ga. 30093 / (404) 923-6666
TWX 810-766-4915 (QUADRAM NCRS)

Part No. 12-9528-01 / Rev 4



For Series 5300

CONTENTS

Page

Foreword

Quadboard Operation Manual

Includes

- Quadboard Manual (384K version)
- Quadboard Memory Settings
- Quadboard Startup Address
- Party Enabling/Disabling
- Assign Party Numbers
- Quadboard Port
- Quadboard
- Quadboard Troubleshooting Manual

Appendix

- Quadboard Party Numbers

Quadboard Manual (384K version)

Before attempting to install Quadram's Quadboard, read this operations manual thoroughly. If for any reason you should require technical assistance or advice, contact your authorized Quadram dealer or local computer retailer.

© 1984 Quadram Corporation. All Rights Reserved

Quadboard
Operation
Manual

CONTENTS	Page
Foreword	1
Introduction	3
Description	6
Memory	6
Async Interface	6
Parallel Interface	7
Chronograph	8
Game Port	8
DIP Switch and Jumpers	9
Installation	10
PC Memory Expansion	12
Quadboard Memory Settings	16
Quadboard Starting Address	16
Parity Enabling/Disabling	17
Async (Serial) Interface	18
Parallel Printer Port	19
Game Port	19
Installing the Connector Bracket	20
Operation	23
Quadboard Memory Enabling and Starting Address	23
Quadboard Memory Parity	24
Async Interface Operation	24
Parallel Printer Operation	25
Chronograph Operation	26

CONTENTS

1 Introduction

2 Description

3 Memory

4 Async Interface

5 Parallel Interface

6 Character Set

7 Data Port

8 DIP Switch and Jumpers

9 Installation

10 PC Memory Expansion

11 Quadram Memory Settings

12 Quadram Starting Address

13 File Encoding/Decoding

14 Async (Serial) Interface

15 Parallel Printer Port

16 Data Port

17 Installing the Commentor Bracket

18 Operation

19 Quadram Memory Encoding and Starting Address

20 Quadram Memory Parity

21 Async Interface Operation

22 Parallel Printer Operation

23 Character Set Operation

WARRANTY PROVISIONS

The Quadram Corporation warrants this product to be in good working order for a period of one year from the date of purchase as a new product. Should this product fail to perform properly any time within that one year period, Quadram Corporation will, at its option, repair or replace this product at no cost except as set forth in this warranty. Replacement parts or products will be furnished on an exchange basis only. Replaced parts and/or products become the property of Quadram Corporation. No warranty is expressed or implied for products damaged by accident, abuse, misuse, natural or personal disaster, or unauthorized modification.

Warranty service described herein may be obtained by delivering this product, during the one year warranty period, to any authorized Quadram Dealer or to Quadram's Factory Service Center located at 4355 International Blvd., Norcross, Georgia, 30093. Whether delivering to a Dealer or to the Factory, product must be accompanied by proof of purchase date. If shipped by U.S. Mail or any common carrier, owner agrees to insure and accept all liability for loss or damage to this product, to prepay all shipping charges, and to use shipping container equivalent to original packaging.

WARRANTY LIMITATIONS

All warranties for this product expressed or implied, including merchantability and fitness for a purpose, are limited to a one year duration from date of purchase, and no warranties, expressed or implied, will apply after that period.

If this product does not perform as warranted herein, owner's sole remedy shall be repair or replacement as provided above. In no event will Quadram Corporation be liable to any purchaser for damages, lost revenue, lost wages, lost savings, or any other incidental or consequential damages arising from purchase, use or inability to use this product, even if Quadram has been advised of the possibility of such damages.

Periodic updates or changes to this material will be made in new editions of this publication.

Requests for dealer information, comments or other inquiries may be addressed to: Quadram Corporation, 4355 International Blvd., Norcross, Georgia 30093. Quadram Corporation has no obligation to return or hold confidential any material or information you supply unless arrangements are made pursuant to Quadram's receipt of said information.

FOREWORD

Quadram now gives IBM PC and XT users greater flexibility and more expansion possibilities with Quadboard. Regardless of whether the IBM Personal Computer is being used at home or at the office, Quadboard can solve a major problem many users have. Because Quadram has taken 9 of the most-needed IBM PC functions and combined them all onto one board requiring just one expansion slot. This leaves the IBM with the rest of its slots free for future expansion.

Quadboard contains a serial RS-232C communications port, a Centronics compatible parallel printer port, up to 384K of RAM, chronograph (real-time clock/calendar), game port, QuadRAM Drive (RAM Disk) software, MasterSpool (software print spooler), MasterCache (disk caching), and Qswap (a line printer swap program).

A DIP Switch and jumper pins provided on the Quadboard allow you to program the board for the specific needs of your system.

The parallel and serial ports are functionally identical to IBM's.

The chronograph (extremely accurate clock/calendar) uses a crystal controlled integrated circuit with a life time rechargeable battery.

And the game port is fully IBM-compatible. It can be used with game paddles or joysticks.

Included in the Quadboard package is the QuadMaster II disk: software designed to let you get the most out of the Quadboard in your system. Complete software instructions and descriptions are included in the "QuadMaster II Operations Manual."



Quadram's Quadboard

INTRODUCTION

Quadboard from Quadram Corporation is a multifunction board designed especially for the IBM Personal Computer and PCXT. Quadboard greatly increases the operational capabilities of the computer while using only one of the computer's expansion slots. The following hardware functions are implemented on the Quadboard.

- 1) Random Access Memory (RAM) expansion in 64K increments from 0 to 384K,
- 2) An EIA RS-232C serial interface for asynchronous communications,
- 3) A Centronics compatible parallel printer interface,
- 4) A battery-powered chronograph,
- 5) And, an IBM compatible game port.

Figure 1 is a block diagram of the Quadboard showing its major features and their approximate locations on the board.

Additionally, QuadMaster II software is included in the Quadboard package. Provided in this software are programs to use part of the Quadboard's memory as single or multiple RAM drives, set up a print buffer in Quadboard memory, and execute a line printer swap program to change LPT1 and LPT2 back and forth. There are also programs to set the date and time for the chronograph, as well as many other useful utilities.

The Quadboard is completely hardware and software compatible with the Personal Computer and is designed for performance and reliability. It has been constructed of high-quality components and engineered for minimum power consumption to keep the computer running cool. Each board has been "burned-in" and thoroughly tested to insure years of reliable service.

Extended Warranty

In addition to the one-year warranty provision detailed elsewhere in this manual, Quadram offers a five-year extended warranty when the Quadboard (384 version) is purchased fully populated.

**FIGURE 1
QUADBOARD BLOCK DIAGRAM**

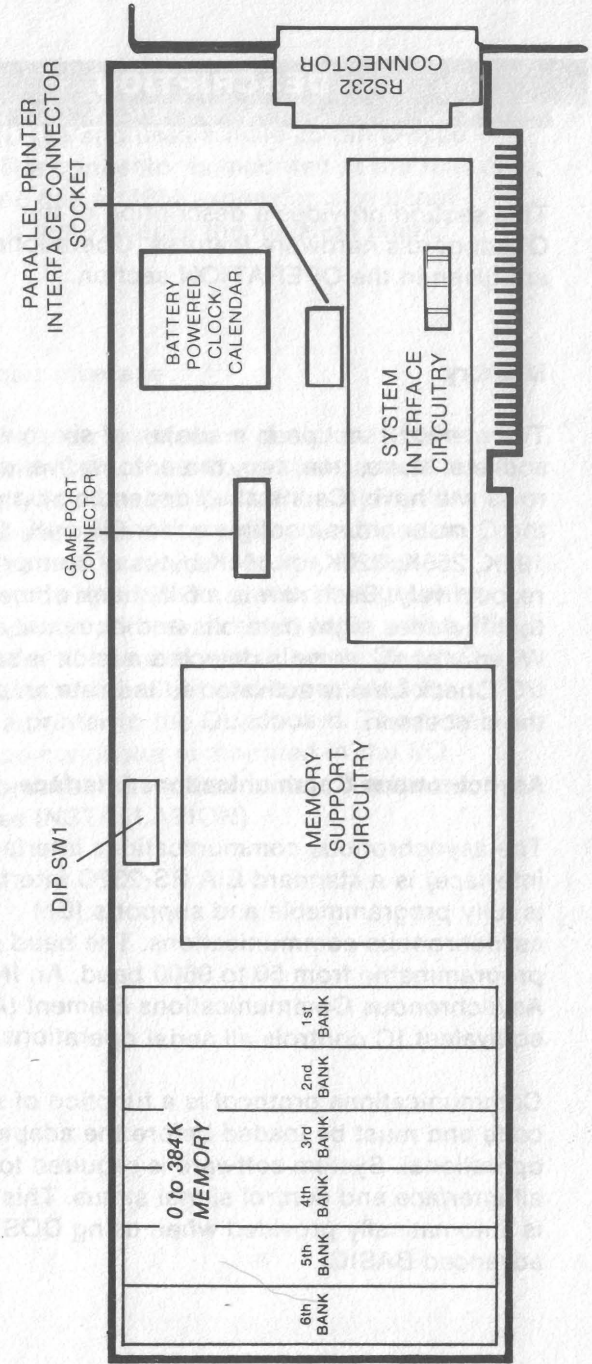

DESCRIPTION

This section provides a description of the Quadboard's hardware features. Operational details are given in the OPERATION section.

Memory

The memory section is made up of six rows of nine sockets. None, one, two, three, four, five, or six rows will have ICs installed depending on whether the Quadboard is configured for 0K, 64K, 128K, 192K, 256K, 320K, or 384K bytes of memory, respectively. Each row is a 64K bank of memory that includes eight data bits and one parity bit. When a parity error is detected a latch is set and an I/O Check Line is activated to indicate an error to the processor.

Asynchronous Communications Interface

The asynchronous communications interface (serial interface) is a standard EIA RS-232C interface that is fully programmable and supports IBM asynchronous communications. The baud rate is programmable from 50 to 9600 baud. An INS 8250 Asynchronous Communications Element (ACE) or equivalent IC controls all serial operations.

Communications protocol is a function of system code and must be loaded before the adapter is operational. System software is required to handle all interface and control signal status. This software is automatically provided when using DOS or advanced BASIC.

The serial interface is implemented as data terminal equipment (DTE) and uses a male 25 pin D-type connector. The connector is mounted at the rear of the board and has an IBM expansion slot panel mounted to it that replaces the installed blank panel.

Parallel Printer Interface

The parallel printer interface is designed to connect to printers with Centronics compatible interfaces. It is functionally identical to IBM's Parallel Printer Adapter and supports the graphics functions on many printers with graphics features. Driver software may be required to support the graphics functions in some printers. A short cable with a 16 pin DIP header at one end and a female 25 pin D-type connector at the other end is provided for interfacing a printer to the Quadboard. The female 25 pin D-type connector is mounted in the I/O connector bracket that comes in the Quadboard package (see INSTALLATION).

Chronograph

The chronograph is a battery powered, crystal controlled date and time keeping circuit that is used to set the Personal Computer's own internal Clock/Calendar whenever DOS is booted from a disk. A NiCad battery provides power for the chronograph when the PC is turned off. The battery is recharged when the PC is turned on. An adjustment is provided for setting the accuracy of the chronograph. This is preset at the factory and normally will not require adjustment. Software for accurately setting the PC's internal clock/calendar when DOS is booted is provided on the accompanying QuadMaster disk. A program is also provided on the QuadMaster disk for setting the Quadboard's chronograph.

Game Port

The game port is designed to connect the Quadboard to a pair of joysticks or a game paddle. The port is fully IBM compatible. A short cable with a 15 pin DIP header at the Quadboard end and a female 15-pin D-type connector at the other end — plugged into the I/O connector bracket included in the Quadboard package — is provided for the interfacing.

DIP Switch and Jumpers

An eight-position DIP switch is mounted on the Quadboard to allow you to program memory, parity, game port, and clock functions. With this DIP Switch you can:

- 1) Set the Quadboard's starting memory address;
- 2) Enable or disable the memory installed on the Quadboard;
- 3) Enable or disable parity checking of the Quadboard's memory;
- 4) Enable or disable the game port;
- 5) And enable or disable accessing of the Quadboard's chronograph.

INSTALLATION

The Quadboard may be plugged into any slot in the Personal Computer. Refer to the IBM "Guide to Operations" manual for detailed instructions on opening the PC chassis and installing option boards.

WARNING: Be sure the Personal Computer is turned off before removing the cover. You may also wish to disconnect any power cables attached to the system. Never insert or remove an option board with the PC's power ON. Damage to the option board or PC could result.

Before installing the Quadboard in the Personal Computer certain programmable options need to be selected by setting appropriate DIP switch positions and establishing the appropriate jumpers on the board. These settings are explained in the following sections. Figure 2 shows the location and detail of the Quadboard's DIP Switch and Jumper options.

One of two types of DIP switches will be found on the Quadboard. One type has slide switches. These are On when the switch has been moved to the "ON" position or as indicated by the arrow. The switch is OFF when it is moved in the opposite direction.

The other type is a rocker switch. Here the switch is set to ON by rocking the switch down to the "ON" position or as indicated by the arrow. The switch is set to OFF by rocking it down in the opposite direction.

FIGURE 2
QUADBOARD DIP SWITCH DETAILS

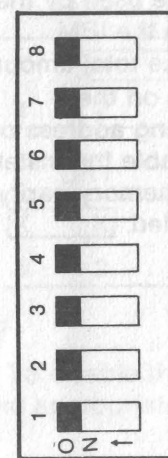

All switches on Switch 1 are shown in the "ON" position.

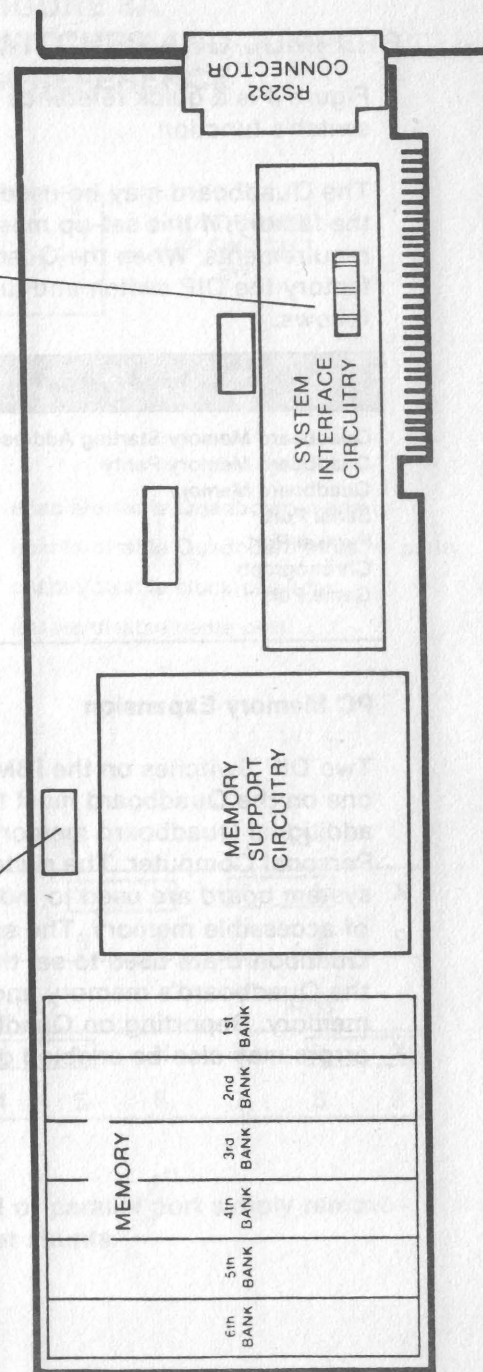

Figure 3 is a quick reference guide explaining each switch's function.

The Quadboard may be used as it is shipped from the factory, if this set-up meets your system requirements. When the Quadboard leaves the factory the DIP switch and jumpers are set as follows:

Table 1: Quadboard Factory Setting

Quadboard Memory Starting Address	64K
Quadboard Memory Parity	OFF
Quadboard Memory	Enabled
Serial Port	COM1
Parallel Port	LPT1
Chronograph	Enabled
Game Port	Enabled

PC Memory Expansion

Two DIP Switches on the IBM system board and one on the Quadboard must be set before the additional Quadboard memory can be used by the Personal Computer. The switches on the IBM system board are used to indicate the total amount of accessible memory. The switches on the Quadboard are used to set the starting address of the Quadboard's memory and to enable the installed memory. Reporting on Quadboard memory parity errors may also be enabled or disabled.

**FIGURE 3A
QUADBOARD SWITCHES AND JUMPERS
QUICK REFERENCE**

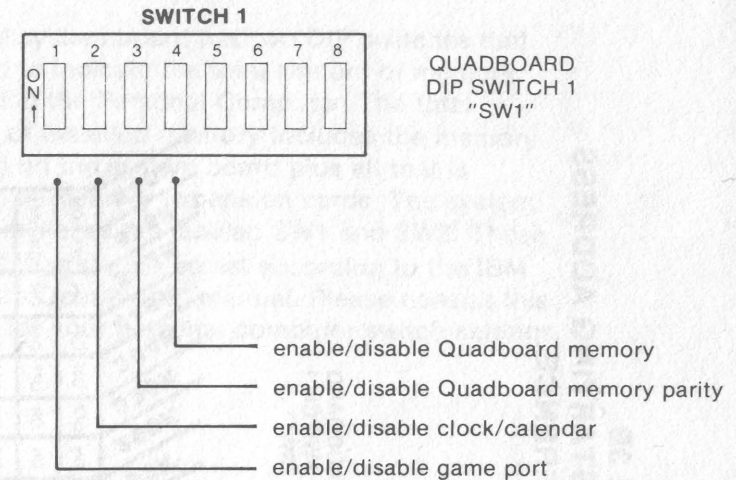

JUMPERS *

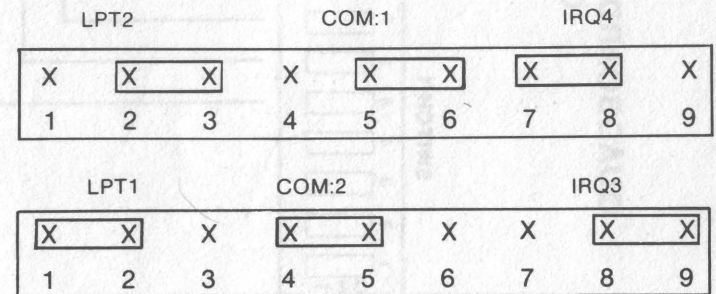

* To disable the serial or parallel port simply remove the appropriate jumper shunts.

**FIGURE 3B
QUADBOARD MEMORY STARTING ADDRESS
QUICK REFERENCE**

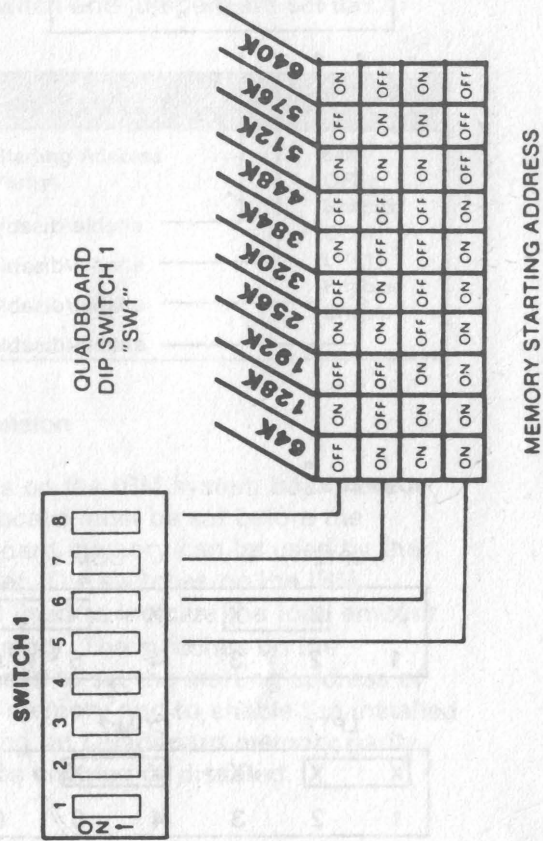

IBM PC System Board Switch Settings

The IBM system board has two DIP switches that are used to indicate the total amount of memory installed in the Personal Computer. The total amount of installed memory includes the memory installed on the system board plus all that is installed in memory expansion cards. The system board's switches are labeled SW1 and SW2. These two switches should be set according to the IBM "Guide to Operations" manual. Please consult this manual for your personal computer switch settings.

Quadboard Memory Switch Settings

The Quadboard also has a DIP Switch that must be set before its memory can be utilized. This DIP Switch is used to set the starting address of the Quadboard's memory and enable the accessing of the installed memory. Memory parity may also be enabled or disabled. The DIP Switch is labeled SW1 and is located along the top edge of the Quadboard as it is installed in the PC. Figure 2 shows the actual location of the switch.

Quadboard Memory Starting Address

The starting address of the Quadboard is switch-selectable in 64K increments. Before your Quadboard can be utilized in the PC, however, the system motherboard must be fully populated, i.e., a 16/64 system should contain 64K of RAM and a 64/256 system should be upgraded to 256K.

To do so, either contact your dealer or consult your computer's own guide to operations manual for system board memory expansion instructions.

If additional memory expansion boards are being used in your system, the Quadboard's starting address will normally begin where the others end. In other words, if you currently have a fully-populated 64K system board along with a 128K memory expansion board and are adding a Quadboard, set its starting address to 192K.

Table 2: Quadboard Memory Starting Address

STARTING ADDRESS	QUADBOARD SWITCH 1 POSITIONS:			
	5	6	7	8
64K	ON	ON	ON	OFF
128K	ON	ON	OFF	ON
192K	ON	ON	OFF	OFF
256K	ON	OFF	ON	ON

NOTE: All four switches should never be in the "ON" position.

Quadboard Memory Parity Enabling/Disabling

DIP Switch position 3 is used for enabling or disabling the reporting of Quadboard memory parity errors to the system board. Selecting the OFF position keeps memory parity errors from being recognized by the system board. The ON position allows them to be recognized. The normal position for most users will be the ON position.

Asynchronous Communications (Serial) Interface

The only set-up required for the serial port is the selection of its address and interrupt via the jumper pins located near the board's edge connector as shown in Figure 2. The serial port can be addressed as COM1 or COM2. It is functionally identical to IBM's serial port design. Table 3 lists the settings for programming the serial port.

If you're using the Quadboard in an IBM PC already equipped with an async adapter card addressed as COM1, remember to configure Quadboard's serial port as COM2 to prevent conflict between the two.

Table 3: Serial Port Selection

Interrupt Selection Pins	Address Pins
7/8 (IRQ4)	5/6 (COM1)
8/9 (IRQ3)	4/5 (COM2)

Parallel Printer Port

Included with the Quadboard is a 16 conductor printer cable with a 16 pin DIP header on one end and a female 25 pin D-type connector on the other end.

The 16 pin DIP header plugs into a mating 16 pin socket on the Quadboard. Figure 6 shows details of the 16 pin DIP Header installation. The DIP Header should be plugged into the socket with the blue conductor of the flat ribbon cable closest to the rear of the board and the brown conductor toward the front of the board.

Jumper pins 1, 2, and 3 are used to establish the address of the parallel printer port. It can be addressed as device LPT1 or LPT2.

Table 4: Parallel Port Selection

Address Pins	Designation
1/2	LPT1
2/3	LPT2

Game Port

The Quadboard also features a game port. The game port has a 15 pin connector cable installed with a 15 pin DIP Header at one end and a 15 pin female D-type connector at the other end. The 15 pin Header plugs into a mating socket on the Quadboard (See Figure 6). It should be plugged in with the ribbon cable flowing upward.

Bracket Installation

When the Quadboard comes to you, the expansion port connectors are not installed in the bracket. You must do this to use the bracket. Installing the port connectors into the bracket is easy to do. A pair of needle nose pliers will help you with the task.

If you look at one of the expansion connectors you will notice two screw mounts on either side of the interface connector frame. These screw mounts are held in place on the other side of the connector frame by a lockwasher and a small nut. Remove these two screw mounts by turning the screw mount while you hold the nut in place with the needle nose pliers. When out, collect the screw mount, lockwasher, and the small nut and keep them together.

Next, insert the expansion port connector inside the bracket so that it protrudes through one of the matched expansion port openings on its front plate. Now take one of the removed screw mounts and insert it through its proper opening in the expansion port. Hold the connector in place while you are doing this or it may slide out of alignment. Then slip the lockwasher over the screw inside the bracket and then put on the nut over the washer and screw the expansion port in place. This installation procedure follows the screw mount removal procedure in reverse.

Repeat these steps for the expansion port's other screw mount.

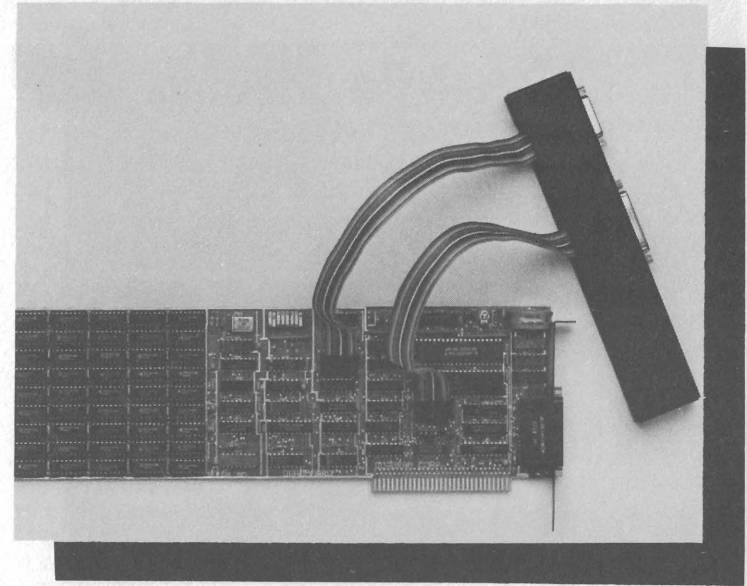

Fig. 6: Quadboard ready for installation

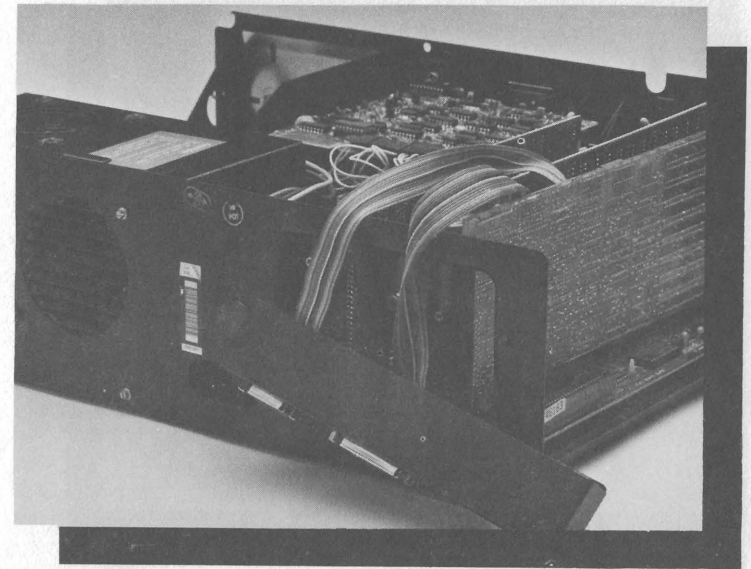

Fig. 7: Quadboard installed and ready for bracket installation

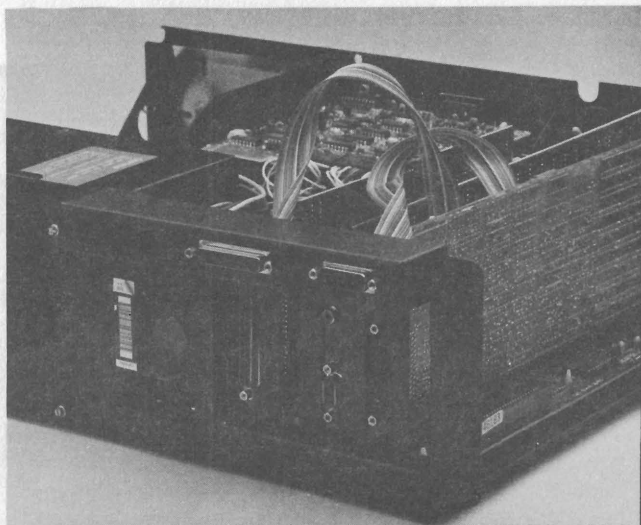

Fig. 8: Attaching the bracket to the PC chassis



Fig. 9: The installed bracket

OPERATION

Details of the operation of the Quadboard's hardware are discussed in the following sections. This information is provided for more advanced users or those who have special system requirements. However, the instructions in the installation section should be sufficient for most users.

NOTE: When the PC is first turned on, a check of all the installed memory is performed. This check typically takes about 15 seconds when 64K of memory is installed on the PC's system board. With a 384K Quadboard installed, this memory check can take as long as 60 seconds. Be prepared for a longer wait before the disk starts spinning when the PC is first turned on.

Quadboard Memory Enabling and Starting Address

There are no special instructions or additional information for enabling the Quadboard's memory or for setting up the Quadboard starting address. As mentioned in Fig. 3A, Quadboard memory can be turned off by setting switch position 4 off.

Quadboard Memory Parity

Quadboard memory parity is checked and errors reported via DIP Switch #3 (see Figure 3A); the position of the switch either enables or disables a parity check channel from the Quadboard to the system board.

While you may choose to enable parity checking as a standard feature, note that with SW3 "OFF," there is no parity check. Instead, an in-line register causes parity to appear consistently "good" when a Quadboard memory location is accessed; you may use this feature to your advantage and run programs which ordinarily lock up your system when parity errors do occur.

Asynchronous Communications Interface

As mentioned earlier, the serial port is virtually compatible with IBM's design for their asynchronous communications interface. However, there is one small difference and that is the 20 milliamp current loop interface option is not implemented on the Quadboard. Refer to the appropriate IBM manual for a description of the serial port's capabilities (i.e., baud rate, number of data bits, parity sense, etc.). BASIC and DOS provide simple commands for setting the serial port's programmable features. Additionally, a programmer can program the serial interface IC (an INS 8250 or equivalent) to meet any special needs. Table 5 lists the pins used on the serial interface connector. All listed signals are connected to the serial interface IC and may be read or controlled through this IC.

Table 5: Serial Port Connector Signals

PIN NUMBER	RS-232 SIGNAL
1	PROTECTIVE GROUND
2 from Quadboard	TRANSMITTED DATA (TXD)
3 to Quadboard	RECEIVED DATA (RXD)
4 from Quadboard	REQUEST TO DATA (RTS)
5 to Quadboard	CLEAR TO SEND (CTS)
6 to Quadboard	DATA SET READY (DSR)
7	SIGNAL GROUND
8 to Quadboard	CARRIER DETECT (CD)
20 from Quadboard	DATA TERMINAL READY (DTR)
22 to Quadboard	RING INDICATE (R)

Parallel Printer Operation

The parallel printer interface is a standard Centronics type interface. The design is functionally identical to IBM's design except for three seldom used signals that are not brought out: AUTO FD XT, ERROR, and SLCT IN. Table 6 lists the signals that are supported in the parallel printer interface.

NOTES

Table 6: Parallel Printer Interface Signals

PIN NUMBER	SIGNAL
1	from Quadboard
2	STROBE
3	DATA 1 (LSB)
4	DATA 2
5	DATA 3
6	DATA 4
7	DATA 5
8	DATA 6
9	DATA 7
10	DATA 8 (MSB)
11	ACK
12	BUSY
13	to Quadboard
14	• PE
15	SELECT
16	NOT USED
17-23	NOT USED
19	NOT USED
25	** INIT
	GROUND
	GROUND

Chronograph Operation

The chronograph's battery is warranted to last five years; a typical lifetime is closer to ten years. The IBM PC can remain turned off for periods up to 6 months and the chronograph circuitry, powered by the battery, will continue to keep accurate time. The battery is recharged when the PC is turned on. An adjustment is provided for changing the chronograph's time base to make it run faster or slower.

The Quadboard's chronograph is used to load the PC's internal clock/calendar when DOS is booted. Software provided on the QuadMaster disk is used to read the Quadboard's chronograph circuitry, format the date and time into DOS, and store the date and time for use by the PC's internal clock/calendar.

NOTES

Get more out of your Personal Computer system with these other fine Quadram Products

Quadboard

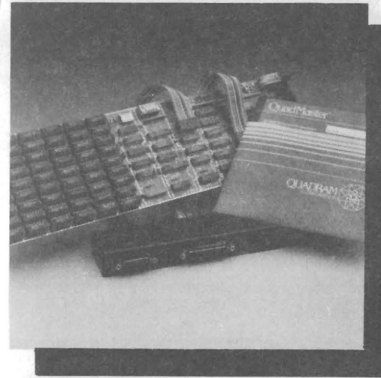

Quadram's Quadboard is a ten-function expansion board for the IBM Personal Computer. It is designed to greatly increase the PC's capabilities for minimum cost while using only one internal expansion slot. The functions provided on this one board include: Random Access Memory (RAM) expansion from 64K to 384K bytes in 64K increments, an EIA RS-232C Serial Interface for asynchronous communications, a Centronics compatible parallel interface for printer driving, a battery-powered Quartz clock/calendar to keep your PC's internal clock always on time, a game port, an expansion port connector bracket, plus complete Quadmaster II software.

Quadboard II

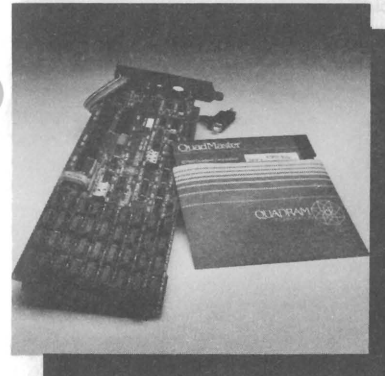

Quadram's Quadboard II is an all-on-one board which combines six IBM PC functions in one. This multifunction board combines two serial ports, chronograph, and memory expansion — all compatible with IBM PC hardware. The two RC-232 async ports can be used for modems, printers, and other serial devices. Memory expansion is socketed and fully expandable in 64K increments up to 256K. Full parity generation and checking are standard. Also included is complete Quadmaster II software.

Quad 512+

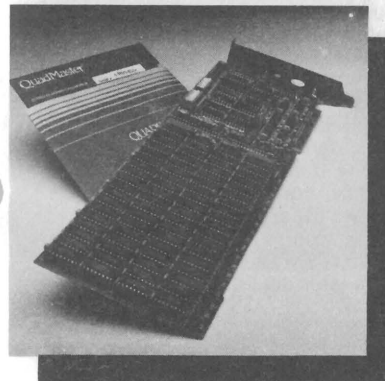

Now IBM PC owners can enjoy faster computing times and more capabilities with the Quad 512+. This board from Quadram combines memory expansion of 512K RAM in increments of 64K, 256K, or 512K with a serial port. The RS-232C async serial port uses the same chip as the IBM serial board and is used for connecting modems, printers, and other serial devices. Also included is complete Quadmaster II software.

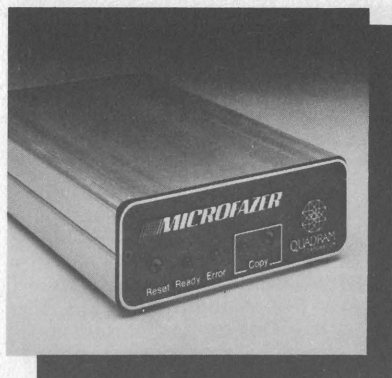

Microfazer

The Quadram Microfazer is a universal print buffer with 8K to 512K RAM — the first with a half-megabyte! The Microfazer receives information in its memory, then sends it to the printer at an appropriate speed. The Microfazer comes with a copy feature allowing additional copies of the buffered information. The unit is sized to stack with popular modems and other peripherals; and some even plug directly into the printer!

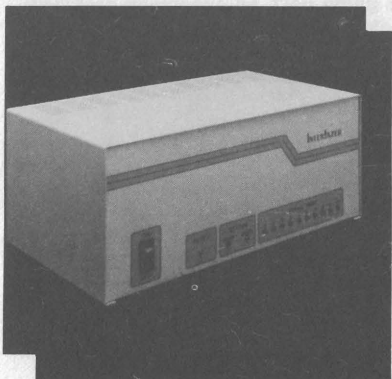

InterFazer

The InterFazer from the Quadram Corporation is an intelligent peripheral controller/buffer designed to provide interfacing and priority control for up to eight output devices feeding and sharing one or two input devices. The inputs and outputs may be in any combination of serial or parallel. The InterFazer's state-of-the-art design allows it to function as a multi-user printer controller, an incompatible device interface, a computer I/O expander, a peripheral multiplexer, a data transfer rate converter, and an additional peripheral buffer.

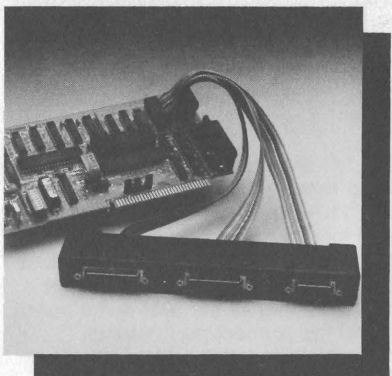

Quad I/O

Quadram's Quad I/O combines up to five of the most-needed IBM PC input/output devices onto one card. This multifunction board contains a parallel port designed to operate most printers and other parallel devices; a battery-powered chronograph — an extremely accurate real-time clock/calendar; a game port for game paddles, fire buttons, or joysticks; a serial port for connecting modems, printers, and other serial devices; plus an optional second serial port which can be ordered with the board or added at a later date.

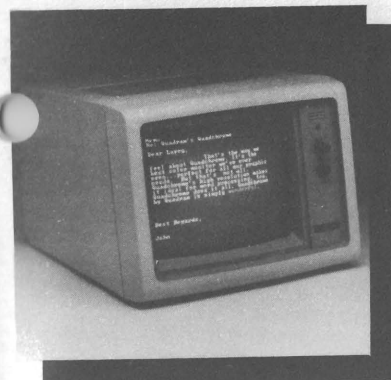

Quadchrome

This is the perfect monitor for any data processing environment — Quadchrome by Quadram. Quadchrome is a high-resolution (690 x 240) RGB color monitor designed with an NEC .31 dot pitch cathode ray tube. The high resolution makes Quadchrome perfect for word processing, spreadsheet programs, and other common business applications. But Quadchrome also has amazing color capabilities. It's able to produce up to 16 different colors on the screen at once. This makes Quadchrome perfect for color graphics work, too.



Quadscreen

Quadscreen is a high-resolution (960 x 512), bit-mapped, "big-screen" monitor for the IBM Personal Computer. The large monochrome screen can display 10,240 characters — more than five times the screen capacity of IBM's PC monitor. Dot addressability, super spreadsheet, and split-screen functions are some of the distinctive elements of Quadscreen that maximize graphics capabilities and increase word processing efficiency. Quadscreen comes with monitor, connector cable, and a video card with 128K bytes of available RAM.

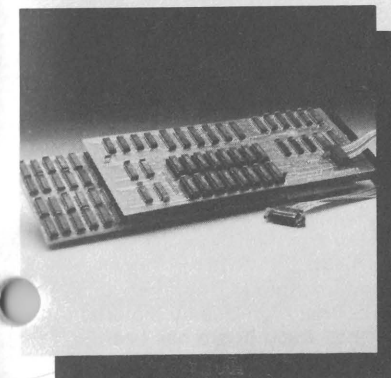

Quadcolor I and II

Quadram presents Quadcolor, the most powerful color graphics adapter package available today. Quadcolor is compatible with the Personal Computer and XT and comes in two versions.

Quadcolor I has 32K of on-board RAM for up to 16 active video pages in text mode and two complete pages in graphics mode. Plus, you get a choice of two true colors in high-resolution mode with Quadcolor I.

Quadcolor II gives you 96K of RAM and lets you choose from 136 different colors for high-resolution bit-mapped graphics. Quadcolor II also comes with BASICQ, an enhanced graphics software package that's powerful and easy to use.

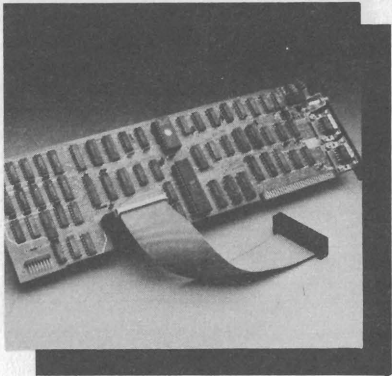

Quadlink

Quadram Quadlink is a revolutionary enhancement board that turns your IBM Personal Computer into an Apple-compatible system. Quadlink is an Apple-emulator that plugs into one of the PC's expansion slots. The board uses the same disk drive and I/O devices as the PC, working in complete harmony with the computer system. With Quadlink, no diskette reformatting is necessary. Just put the Apple diskette in the drive and watch it go.

Quadlink comes complete with printed circuit board and all the necessary cables for integrating the board into the system. Plus there's software for booting the Quadlink and running the Apple DOS 3.3 and thorough documentation explaining the installation and operation of the board.

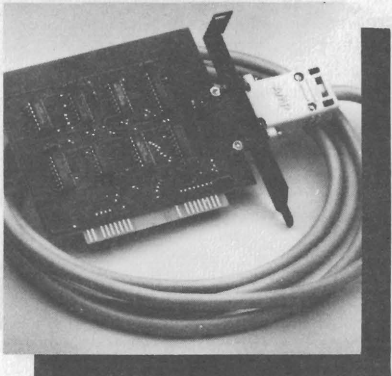

IPIC

Quadram's IPIC (IBM Parallel Interface Card) is a general purpose Centronics parallel interface card complete with cable for the IBM Personal Computer. It is specifically designed to drive printers, but may be used as an I/O driver for any parallel device that matches its input/output capabilities. The IPIC works exactly like IBM's Parallel Printer Adapter and supports the graphics function on many common graphics printers including IBM, Epson, Centronics, and others.

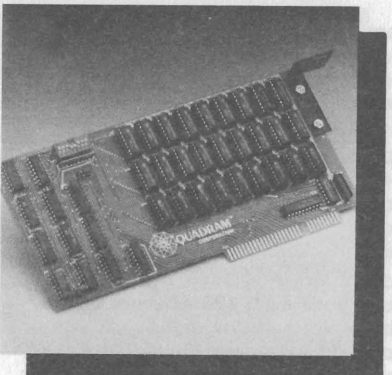

Memory Expansion Board

Perfectly compatible with other peripheral cards, Quadram's Memory Expansion Board is designed to increase the random access memory capacity of the IBM Personal Computer in 64K byte increments up to 192K. The Memory Expansion board has been manufactured with performance and reliability in mind, and has been constructed of only high-quality material and components. Each board has been burned-in and thoroughly tested to insure many years of dependable service.

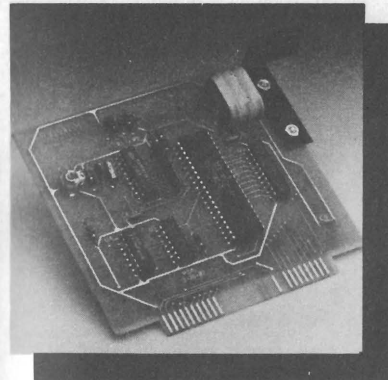

Clock/Calendar

The Clock/Calendar Card from Quadram Corporation is a small plug-in unit designed for the IBM Personal Computer. It provides an accurate crystal-controlled date/time keeping function which automatically sets the IBM DOS internal clock/calendar whenever DOS is booted from a diskette. The card is powered by a self-contained battery automatically recharged by the computer, and provides continuous time keeping even when the computer is off for long periods of time.

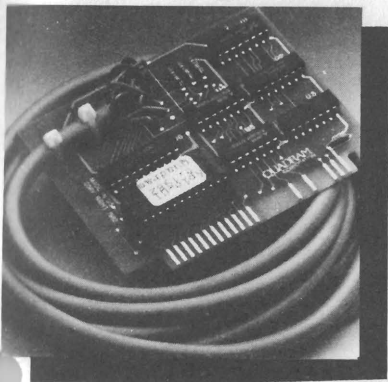

APIC Graphics

The Apple Parallel Interface Card is manufactured by the Quadram Corporation as a Centronics compatible parallel interface for the Apple II and Apple II+ computers. The card contains a graphics option. Both Apple Graphics pages can be printed from the screen with several simple commands.

APIC-G has many text features, including adjustable margins, page length, line length, and others. APIC-G is available for several types of printers.

The Quadram Qlique (pronounced clique)

You're special to us . . .

As a Quadram product owner, you're very special to us. You've become a preferred customer. And as a preferred customer we want to keep you updated on what's happening at Quadram. That's why we want you in the Qlique (pronounced clique). The Quadram Qlique is a special membership of all our preferred customers. As a member in the Qlique you'll receive information on new product releases and general information about Quadram's complete line of microcomputer enhancements. It's a great way to "stay tuned" to what's happening at Quadram!

Joining the Qlique is easy . .

It's free! All you have to do is complete the attached card and mail it back to us. We'll put you on our membership list and make sure you stay up-to-date on the exciting things going on at Quadram.

C'mon. Get in tune. Join the Qlique by sending in the card today.