

IBM[®] DB2[®] OLAP Server[™]



OLAP Miner User's Guide

Version 7.1

Note

Note: Before using this information and the product it supports, read the information in "Notices" on page 81.

Second Edition (December 2001)

This edition applies to version 7.1 of IBM DB2 OLAP Server (product number 5648-OLP) and to all subsequent releases and modifications until otherwise indicated in new editions.

This document contains proprietary information of IBM®. It is provided under a license agreement and is protected by copyright law. The information contained in this publication does not include any product warranties, and any statements provided in this manual should not be interpreted as such.

Order publications through your IBM representative or the IBM branch office serving your locality or by calling 1-800-879-2755 in the United States or 1-800-IBM-4YOU in Canada.

When you send information to IBM, you grant IBM a nonexclusive right to use or distribute the information in any way it believes appropriate without incurring any obligation to you.

© **Copyright International Business Machines Corporation 2001. All rights reserved.**

US Government Users Restricted Rights – Use, duplication or disclosure restricted by GSA ADP Schedule Contract with IBM Corp.

Contents

About this book.	v
Who should read this book	v
How to send your comments	vi

Part 1. Finding and viewing deviations. **1**

Chapter 1. Getting started with OLAP Miner	3
Before you create deviation detection definitions	3
Starting and stopping the OLAP Miner client application	4
Starting and logging on to the OLAP Miner client application.	4
Stopping the OLAP Miner client application	5

Chapter 2. Viewing the deviations	7
Viewing deviations in the Deviation Viewer or a spreadsheet	8
Analyzing deviations	9

Chapter 3. Linked reporting objects	11
Creating linked reporting objects	11
Deleting linked reporting objects	12

Chapter 4. Tutorial	13
Tutorial business problem	13
Creating a deviation detection definition	13
Naming the deviation detection definition	14
Selecting members from each dimension	14
Running the deviation detection definition	15
Viewing the deviations	17

Part 2. Configuring and managing OLAP Miner **23**

Chapter 5. System architecture	25
-------------------------------------------------	-----------

Chapter 6. Directory structure	27
-------------------------------------------------	-----------

Chapter 7. Configuring the OLAP Miner server.	29
----------------------------------------------------------------	-----------

Chapter 8. Starting and stopping the OLAP Miner server on Windows and AIX.	33
Starting the OLAP Miner server on Windows	33
Starting the OLAP Miner server on AIX.	33
Stopping the OLAP Miner server on Windows and AIX	34

Chapter 9. Configuring the OLAP Miner client	35
---------------------------------------------------------------	-----------

Chapter 10. OLAP Miner server commands	39
-----------------------------------------------	-----------

Chapter 11. OLAP Miner mining run program	41
------------------------------------------------------------	-----------

Chapter 12. Access privileges	45
------------------------------------------------	-----------

Chapter 13. Improving performance and scalability	47
Improving performance	47
Improving scalability	48

Chapter 14. Back up and recovery.	49
----------------------------------------------------	-----------

Appendix A. How OLAP Miner works	51
The OLAP Miner algorithm.	51
Member Only or Member and Descendants selections	51
The subcube	53
The expected value of cell in the subcube	54
The magnitude of the deviation	55
Examples of deviant values in a subcube	56
Example 1	56
Example 2	57
Example 3	57

Appendix B. Working with XML files	59
-----------------------------------------------------	-----------

Appendix C. OLAP Miner client and server messages	61
--------------------------------------------------------------------	-----------

Notices	81
Trademarks	83

Glossary 85
Index 87

Contacting IBM 89
Product Information 89

About this book

IBM® DB2® OLAP Server Miner (OLAP Miner) is a feature of IBM DB2 OLAP Server™. To find deviant values in a multidimensional database (cube), OLAP Miner uses the loaded and calculated data that is created with DB2 OLAP Server. OLAP Miner uses a graphical interface to create deviation detection definitions and display the results of these definitions. This book provides detailed information about using and configuring OLAP Miner.

To use OLAP Miner you should have some familiarity with DB2 OLAP Server and its functions. To create useful analyses with OLAP Miner, you should understand how to create and manipulate OLAP cubes.

This book provides detailed information about how OLAP Miner finds deviations in OLAP cubes. However, you do not need to understand these details to use OLAP Miner effectively. If you want to start creating deviation detection definitions to find deviations in your data, see “Before you create deviation detection definitions” on page 3 and the OLAP Miner online help.

You can also learn how to use OLAP Miner by using the OLAP Miner tutorial. See Chapter 4, “Tutorial” on page 13.

For more information about detecting deviations, see the article “A method for determination of an exception in multi-dimensional data” at <http://www.ibm.com/software/data/db2/db2olap/>.

Who should read this book

Read Part I of this book if you are responsible for:

- Creating or running deviation detection definitions
- Reporting deviations with spreadsheets

Read Part I if you frequently work with OLAP (online analytical processing) cubes and you want to analyze the data for deviant values. You should understand the data and the methods that were used to create the cubes. As an OLAP analyst or “power user,” you might be responsible for creating, editing, managing, and running deviation detection definitions.

Read Chapter 2, “Viewing the deviations” on page 7 if you simply want to examine deviation detection definition results.

See the OLAP Miner online help for more information about creating deviation detection definitions or viewing deviations.

Read Part II of this book if you are responsible for:

- Configuring the OLAP Miner server and client
- Managing access privileges, back up and recovery, and performance
- Scheduling mining runs

As the OLAP Miner administrator, you should have experience in networking and system administration. Read Part II for information about OLAP Miner system architecture, directory structure, server and client configuration files, commands, the mining run scheduling program, access privileges, performance, and file backup and recovery.

How to send your comments

Your feedback is important in helping to provide the most accurate and highest quality information. If you have any comments about this book or any other DB2 OLAP Server documentation, go to the DB2 OLAP Server Web site at <http://www.ibm.com/software/data/db2/db2olap/>.

Part 1. Finding and viewing deviations

Chapter 1. Getting started with OLAP Miner

IBM DB2 OLAP Server Miner™ enables you to examine your OLAP cubes (multidimensional databases) more thoroughly and easily by finding atypical or deviant values automatically. Instead of searching through your data manually to find data values that might be higher or lower than you expected, OLAP Miner can do this work for you. The OLAP Miner algorithm is optimized so that it can be deployed on large OLAP cubes.

You can search specific areas (subcubes) of your cubes by creating deviation detection definitions, which specify the way in which OLAP Miner examines the data that you selected for the subcube. OLAP Miner provides an easy-to-use wizard that helps you create deviation detection definitions.

After you create a deviation detection definition, OLAP Miner applies a deviation detection algorithm to the data to find deviations. After the mining run is finished, you can view a simple list of deviations or view the deviations in the Deviation Viewer. From the Deviation Viewer, you can see the deviations in the context of other surrounding values. For more information about how the OLAP Miner algorithm finds deviations, see Appendix A, “How OLAP Miner works” on page 51.

You can also view deviations in a standard spreadsheet application. If you have the DB2 OLAP Server spreadsheet add-in, you can use all of the features of that product to view or report deviations. See the OLAP Miner online help for information about creating deviation detection definitions and viewing mining results.

Before you create deviation detection definitions

OLAP Miner provides the Deviation Detection wizard to help you create a deviation detection definition. This definition determines how and what portion of the OLAP cube will be analyzed for deviations.

Before you create a deviation detection definition, read the following requirements and restrictions.

Requirements:

Before you create a deviation detection definition:

- Determine which member that you want to search for deviations and select that member as Member Only.

Typically, this member is from the Measures or Accounts dimension.

- Ensure that you use loaded and calculated OLAP cubes for deviation detection definitions.
- Select members from dimensions that use either the addition operator (+) or the no-consolidation operator (~).
- Ensure that the OLAP cubes have a sufficient amount of accurate data at the lowest levels of the dimension hierarchy. If the subcube contains very little data, the mining results might be less useful.

OLAP Miner calculates values by starting from level zero, not from the first generation. For example, if you select Member and Descendants for an entire year to be calculated in a deviation detection definition, OLAP Miner first calculates for deviations by scanning the values for January, February, and March.

- Select label-only members as Member Only.

Restrictions:

The following restrictions apply to creating deviation detection definitions:

- Avoid members that use calculation scripts unless all the values in the subcube that you select are additive. For example, the parent member values must be the sum of all child values.
- If you select a shared member, you are prompted to select the shared member's counterpart base member that has the same name, but is not tagged as shared.
- If you select a member with a non-additive associated formula, OLAP Miner performs the deviation analysis only on the lowest level of data.
- Some members of a cube might be excluded because of their position in their dimension's hierarchy. For example, a member might be excluded because it falls within a non-additive part of the hierarchy.

See the OLAP Miner online help for information about how to start the Deviation Detection wizard to find deviations in your OLAP cube.

Starting and stopping the OLAP Miner client application

To use OLAP Miner, you need to run three components: the OLAP server component of DB2 OLAP Server, the OLAP Miner server, and the OLAP Miner client.

Starting and logging on to the OLAP Miner client application

You can start and log on to the OLAP Miner client application from the Windows Start menu or from a command line.

To start and log on to the OLAP Miner client application from the Windows Start menu:

1. Start OLAP server component. See *OLAP Setup and User's Guide* for more information.
2. Start the OLAP Miner server. For information about starting the server, see Chapter 8, "Starting and stopping the OLAP Miner server on Windows and AIX" on page 33.
3. Start the OLAP Miner client on your workstation. Click **Start** → **Programs** → **IBM OLAP Server 7.1** → **OLAP Miner client**.
The OLAP Miner client application and the Connect window open.
4. Enter your DB2 OLAP Server host name and your DB2 OLAP Server user ID and password.
You will see only the applications and cubes that your user ID is authorized to access.

To start the OLAP Miner client application from a command line:

1. Start the OLAP server component. See *OLAP Setup and User's Guide* for more information.
2. Open a command line.
3. Type `omclient`. Press Enter. The Connect window opens.
4. Enter your DB2 OLAP Server host name and your DB2 OLAP Server user ID and password.
You will see only the applications and cubes that your user ID is authorized to access.

Stopping the OLAP Miner client application

To disconnect from the OLAP Miner server and stop the OLAP Miner client application:

1. From the OLAP Miner main window, click **File** → **Disconnect** to disconnect from the OLAP Miner server.
2. Click **File** → **Exit** to stop the OLAP Miner client application.

Chapter 2. Viewing the deviations

You can view the deviations either as a single value in isolation or in the context of other surrounding values.

After you run a deviation detection definition, a results file is created. If you select this results file, a list of results is displayed in the right pane of the OLAP Miner main window. These results are not shown in context of other surrounding values. The deviations are listed by highest magnitude to lowest magnitude. Deviations with the same magnitude are sorted according to the difference in their absolute residual values. The deviations with the same magnitude that have a greater difference in residual values are sorted first. The most important deviations, based on magnitude, are displayed at the top of the list.

When you select a results file from the left pane of the main window, a list of deviations is displayed in the right pane. Across the top of the right pane, the dimensions that you selected for your deviation detection definition are displayed. Also, two more column headings are added: Expected and Magnitude. See Figure 1 on page 8.

The Expected column shows whether the expected value of a cell is higher or lower than the actual value of that cell.

Magnitude shows that there is a greater or lesser difference between the expected value and actual value of the cell. For more information about how OLAP Miner determines expected values and magnitude, see “The OLAP Miner algorithm” on page 51.

Figure 1 on page 8 shows the various areas of the OLAP Miner main window, specifically the Expected and Magnitude columns in the right pane.

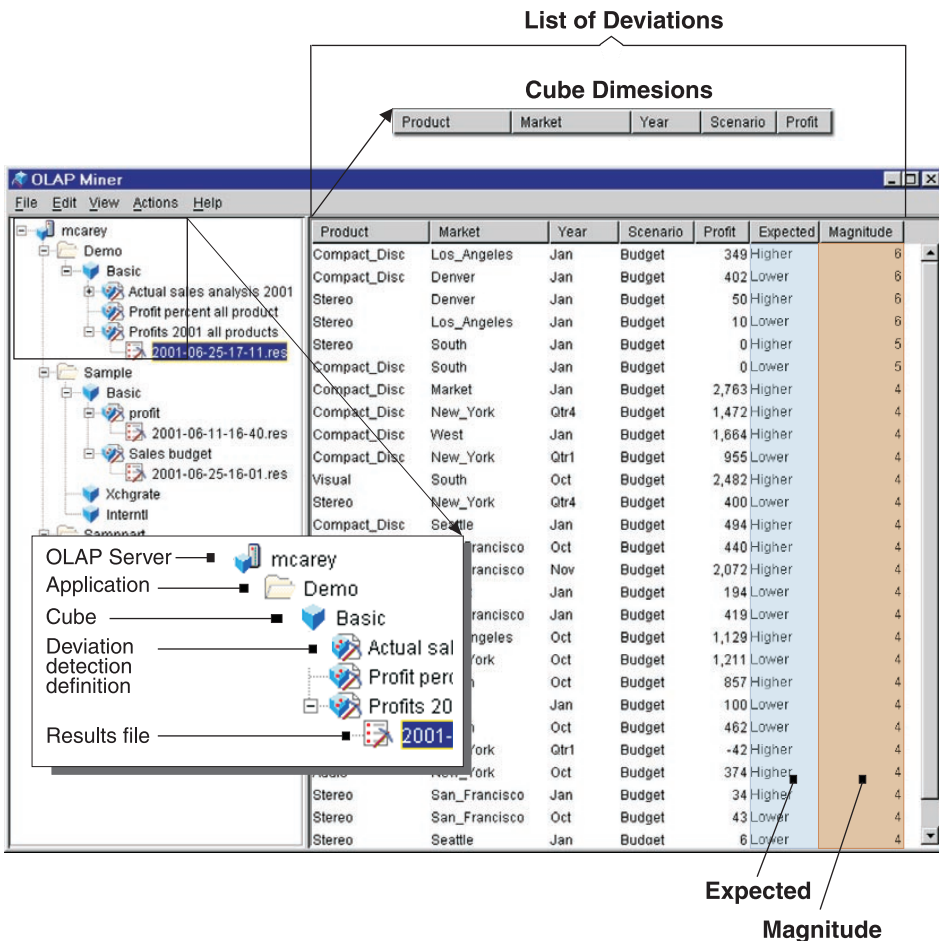

Figure 1. The OLAP Miner main window

Viewing deviations in the Deviation Viewer or a spreadsheet

You can view deviations in the context of other surrounding values with the Deviation Viewer or a spreadsheet application. For information about how to open the Deviation Viewer, see the OLAP Miner online help.

The Deviation Viewer shows the deviation that you selected highlighted in red with a red border. Other deviations that were found in that portion of the subcube are highlighted in red without a red border.

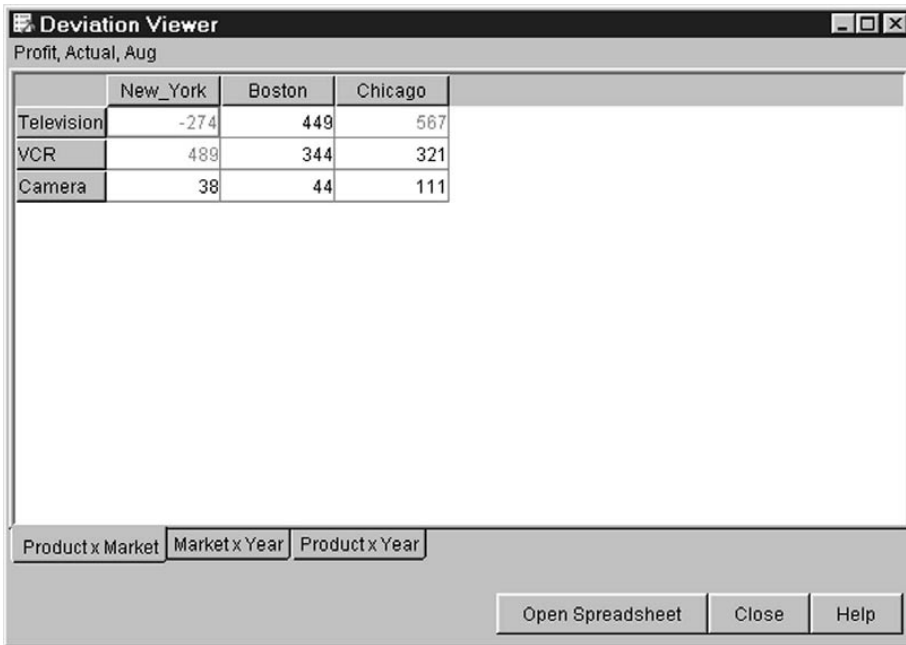

Figure 2. The OLAP Miner Deviation Viewer

You can view deviations in a spreadsheet if you installed the DB2 OLAP Server spreadsheet add-in. In the spreadsheet, you can use the functions of that application to create reports for deviations.

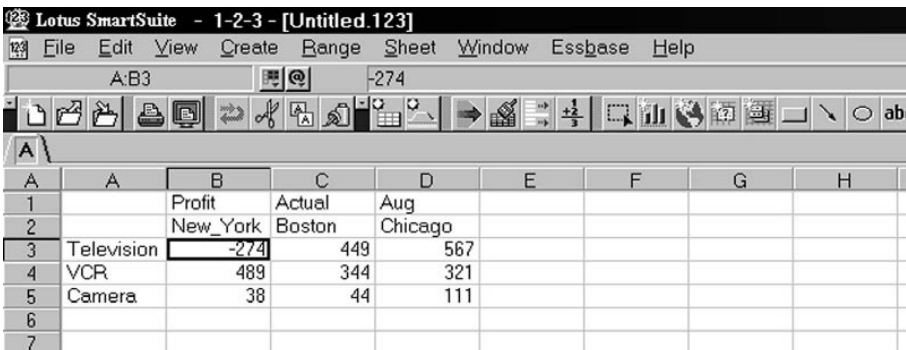

Figure 3. A standard spreadsheet application that shows deviations

Analyzing deviations

After you run a deviation detection definition, you are likely to see many deviations. To understand deviations more clearly, follow these steps:

1. View the deviations, starting with the most significant deviation in descending order of magnitude.
2. In the Deviation Viewer, look closely at the other deviations that are highlighted in red. The other deviations that have higher magnitude values might be the reason for the given deviation. (By moving the cursor over a deviation, you can see the magnitude value and whether the expected value is higher or lower than the actual value.)
3. Continue down the list of deviations in the main window and view each deviation in context by opening the Deviation Viewer. As you read through the list of deviations, the magnitude, or importance, of the deviations decreases. Therefore, the significance of the deviation in the Deviation Viewer is reduced.

Chapter 3. Linked reporting objects

Linked reporting objects (LROs) are objects, for example, text notes, that you associate with specific data cells in an OLAP cube.

The DB2 OLAP Server spreadsheet add-in provides options that can be used to highlight cells that are displayed in the spreadsheet that have associated linked reporting objects. See the *IBM DB2 OLAP Server Spreadsheet Add-in User's Guide* for information about using linked reporting objects with spreadsheets.

With OLAP Miner, you can write deviations from a results file to the OLAP cube as linked reporting objects. In addition, you can remove linked reporting objects that are associated with either a definition or an entire cube. In both instances, OLAP Miner removes only linked reporting objects that it has added to the source cube and leaves all other linked reporting objects intact.

OLAP Miner adds the following information to each linked reporting object for a deviation:

- Magnitude
- Expected value
- The database of the deviation
- The application of the deviation

To view deviations as linked reporting objects in a standard spreadsheet application, you must have the DB2 OLAP Server spreadsheet add-in installed. Also, you must configure the spreadsheet application to highlight linked reporting objects by applying styles. To configure the spreadsheet, go to the Options window and edit the appropriate settings. See the *OLAP Spreadsheet Add-in User's Guide* for more information about configuring your spreadsheet.

Creating linked reporting objects

If you add new linked reporting objects for deviations in a results file, OLAP Miner removes any OLAP Miner linked reporting objects that are associated with the definition to which the results file belongs. This means that only one set of deviations (from a results file) is written to the source cube at any time for any particular definition.

To create linked reporting objects for deviations in a results file:

1. Select a results file from the left pane of the OLAP Miner main window.
2. Click **Actions** → **Create LROs**.
3. Click **Yes** if you want to create linked reporting objects for each deviation in the results file.

Deleting linked reporting objects

You can delete linked reporting objects for a particular deviation detection definition or for a cube.

If you delete a results file, OLAP Miner removes any linked reporting objects that are associated with that results file. Also, if you delete a definition, OLAP Miner removes any linked reporting objects that are associated with that definition.

To delete linked reporting objects for a deviation detection definition:

1. Select a deviation detection definition from the right pane of the OLAP Miner main window.
2. Click **Actions** → **Delete LROs**.
3. Click **Yes** to delete all the linked reporting objects that are associated with the deviation detection definition.

To delete linked reporting objects for a cube:

1. Select a cube from the right pane of the OLAP Miner main window.
2. Click **Actions** → **Delete LROs**.
3. Click **Yes** to delete all the linked reporting objects that are associated with that cube.

Chapter 4. Tutorial

This tutorial provides a guide for a typical business task: finding atypical values (deviations) in multidimensional data. The tutorial shows you how to select an multidimensional database (cube), create a deviation detection definition, find deviations, and interpret the results. You will use Demo Basic as the sample cube. Demo Basic is provided with DB2 OLAP Server. Ensure that you have access to this cube.

Start the OLAP server, the OLAP Miner server, the OLAP Miner client, and then log on to OLAP Miner to begin the tutorial.

Tutorial business problem

You are a business analyst for a retail electronics store. You store your business data in an OLAP cube so that you can view the data from various perspectives. You need to know if there are atypical values, or deviations, in actual sales for all the products in the company.

You could search through the data manually to find deviations. However, finding deviations could be time-consuming, so you decide to use OLAP Miner to do that work automatically.

For the first analysis, OLAP Miner will search for deviations in actual sales for all products in all markets for the year.

Creating a deviation detection definition

OLAP Miner searches through an area of a cube that you define. The area of the cube that you define is called the subcube. The subcube structure is specified in a deviation detection definition. The deviation detection definition specifies which members from the hierarchy of each dimension that you want OLAP Miner to mine for deviations.

To create the deviation detection definition, follow these general steps:

1. Name the deviation detection definition.
2. Select members from each dimension.
3. Run the deviation detection definition.
4. View the mining results.

Naming the deviation detection definition

Specify a name for the deviation detection definition.

1. From the OLAP Miner main window, select the Demo Basic cube.
2. Click **Actions** → **Create deviation detection definition**. The first Deviation Detection wizard window opens.
3. In the **Name** field, type Actual Sales all products 2001.
4. In the **Description** field, type Demo Basic: Actual Sales-all products-all markets-2001.
5. Click **Next**. The second Deviation Detection wizard window opens.

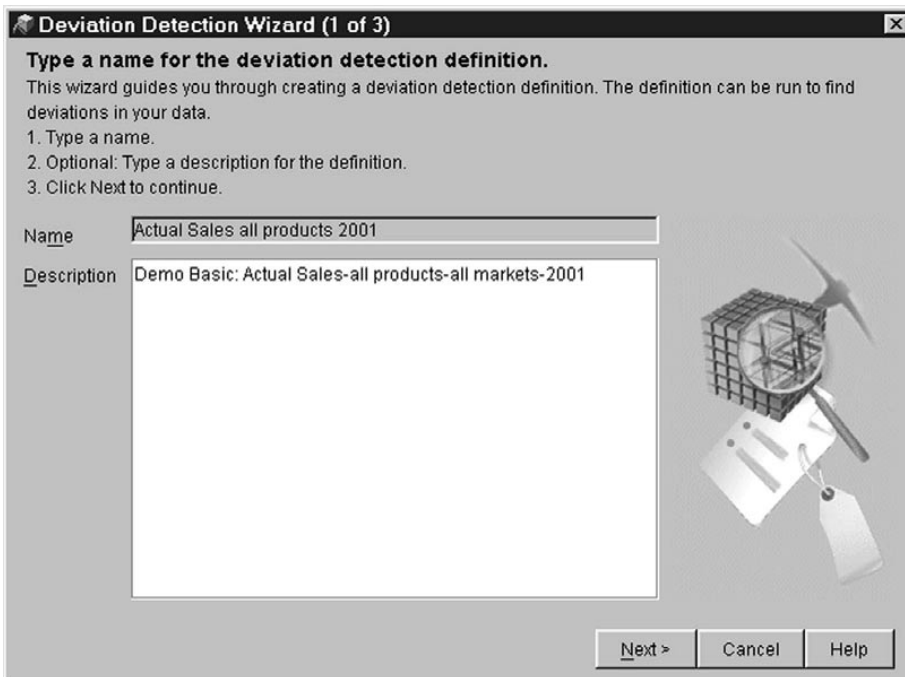

Figure 4. Deviation Detection wizard (1 of 3)

Selecting members from each dimension

In this step, you create a deviation detection definition by defining an area of the OLAP cube (Demo Basic) that you want OLAP Miner to search.

1. Select **Year** and click **Member and Descendants**.
2. Select **Market** and click **Member and Descendants**.
3. Select **Product** and click **Member and Descendants**.
4. Expand **Accounts**, select **Profit**, and click **Member Only**.
5. Expand **Scenario**, select **Actual**, and click **Member Only**.

6. Click **Next**. The third Deviation Detection wizard window opens.

OLAP Miner will search for deviations specifically in actual sales but in the context of the other dimensions.

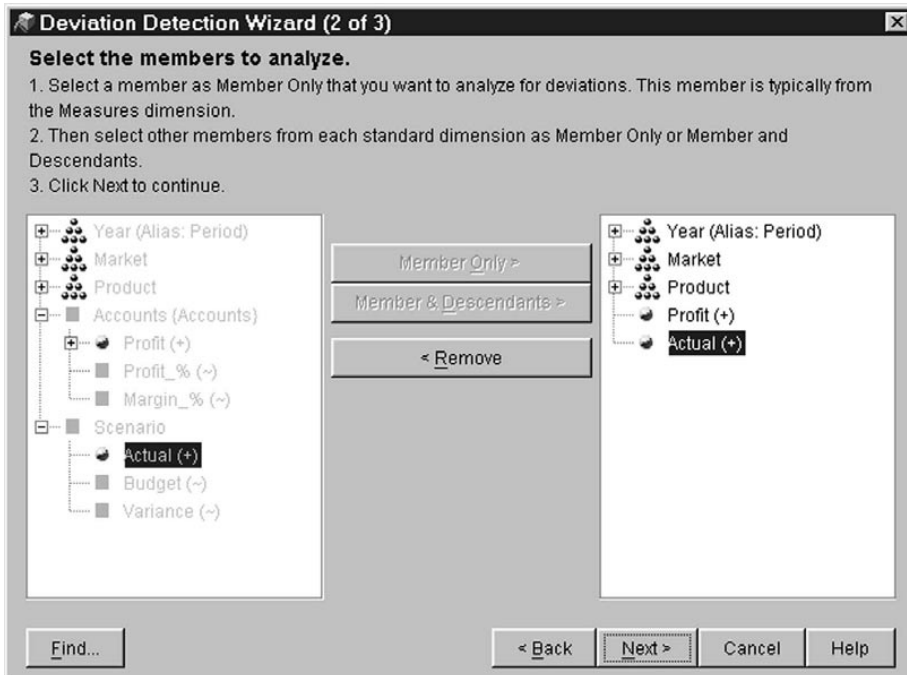

Figure 5. Deviation Detection wizard (2 of 3)

Running the deviation detection definition

OLAP Miner displays the selections that you made in the deviation detection definition. You can specify how many deviations that you want OLAP Miner to return. Leave the default number at 100.

Review the selections and click **Save and Run Now**.

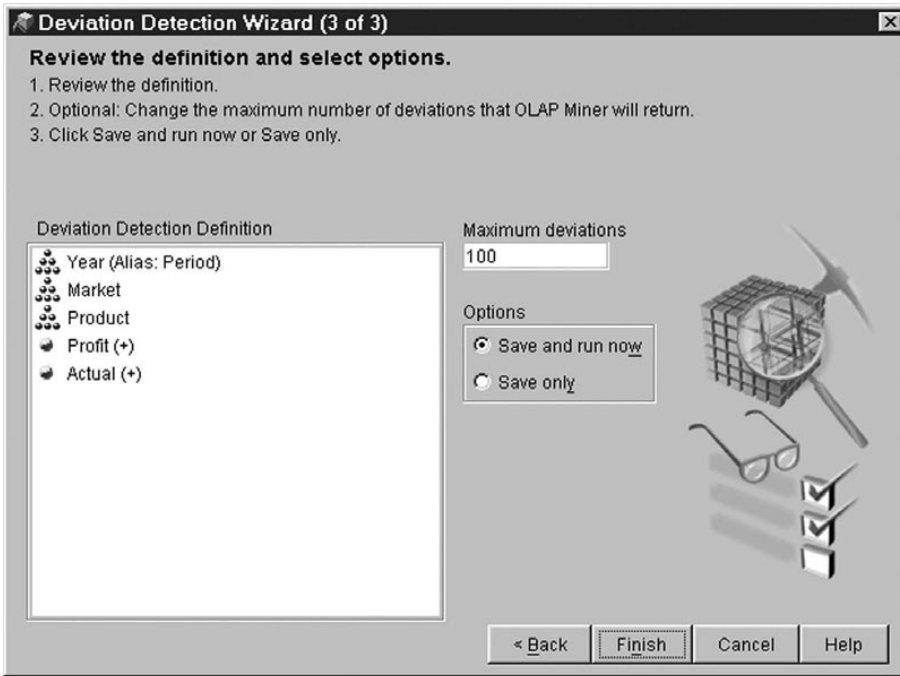

Figure 6. Deviation Detection wizard (3 of 3)

OLAP Miner displays a Progress Display window to show how the mining run is progressing. Because you are using a relatively small cube in this example, the mining run should take only a few minutes.

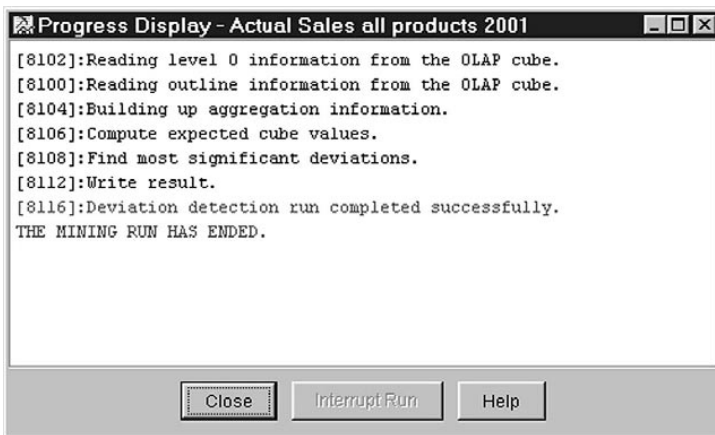

Figure 7. Progress window

Close the Progress Display window.

Viewing the deviations

In this step, you view the mining run results.

1. From the left pane of the OLAP Miner main window, expand the deviation detection definition called Actual Sales Analysis 2001. A results file (.res) with a time stamp is displayed.
2. Select the results file. A list of deviations is displayed in the right pane of the main window.

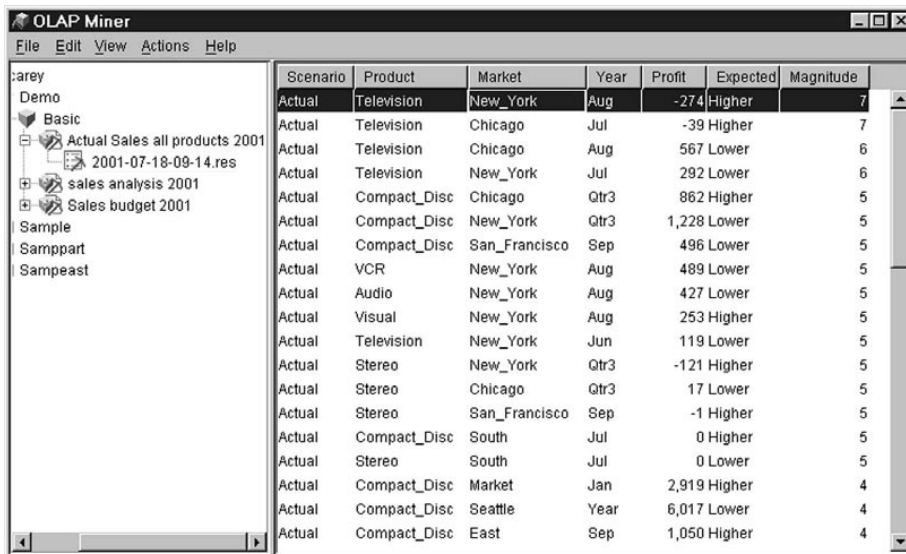

The screenshot shows the OLAP Miner application window. On the left is a tree view with folders like 'Demo', 'Basic', and 'Actual Sales all products 2001'. The main area displays a table of deviations with the following columns: Scenario, Product, Market, Year, Profit, Expected, and Magnitude. The data rows show various products like Television, Compact_Disc, and Stereo across different markets and years, with their respective profit, expected status, and magnitude.

Scenario	Product	Market	Year	Profit	Expected	Magnitude
Actual	Television	New_York	Aug	-274	Higher	7
Actual	Television	Chicago	Jul	-39	Higher	7
Actual	Television	Chicago	Aug	567	Lower	6
Actual	Television	New_York	Jul	292	Lower	6
Actual	Compact_Disc	Chicago	Qtr3	862	Higher	5
Actual	Compact_Disc	New_York	Qtr3	1,228	Lower	5
Actual	Compact_Disc	San_Francisco	Sep	496	Lower	5
Actual	VCR	New_York	Aug	489	Lower	5
Actual	Audio	New_York	Aug	427	Lower	5
Actual	Visual	New_York	Aug	253	Higher	5
Actual	Television	New_York	Jun	119	Lower	5
Actual	Stereo	New_York	Qtr3	-121	Higher	5
Actual	Stereo	Chicago	Qtr3	17	Lower	5
Actual	Stereo	San_Francisco	Sep	-1	Higher	5
Actual	Compact_Disc	South	Jul	0	Higher	5
Actual	Stereo	South	Jul	0	Lower	5
Actual	Compact_Disc	Market	Jan	2,919	Higher	4
Actual	Compact_Disc	Seattle	Year	6,017	Lower	4
Actual	Compact_Disc	East	Sep	1,050	Higher	4

Figure 8. OLAP Miner main window

You can sort the list of deviations by clicking on the heading of a column in the main window.

3. Review the list of deviations. Notice the different columns: Scenario, Product, Market, Year, Expected, and Magnitude.

The first five columns represent the dimensions that you selected in the deviation detection definition. The Expected column describes whether the calculated expected value is higher or lower than the actual value of the cell. OLAP Miner uses the difference between the expected value and the actual value to calculate magnitude. As the difference between the expected value and the actual value increases, the magnitude increases. Higher magnitude values show greater disparities in the data.

4. Select the first deviation (Actual, Television, New_York, Aug, -274, Higher, 7).
5. Click **View** → **Display in Context**. The Deviation Viewer opens.

Deviation Viewer
Profit, Actual, Aug

	New_York	Boston	Chicago
Television	-274	449	567
VCR	489	344	321
Camera	38	44	111

Product x Market Market x Year Product x Year

Open Spreadsheet Close Help

Figure 9. Deviation Viewer, Product by Market view

The deviation that you selected is shown in red with a red border. Other deviations in this area of the subcube are highlighted in red.

Notice that the deviation -274 is significantly different from the other surrounding values. The actual profits in August for televisions in New York is much lower than expected. OLAP Miner calculates the expected value based on all the other values for each dimension that intersects with the cell Television, New York, August, Actual, Profit.

In this example, OLAP Miner determines that the Product by Market view is the most significant. The tabs under the deviations are shown in order of importance with the most important view shown first.

For more information about how OLAP Miner calculates expected values and magnitudes, see “The OLAP Miner algorithm” on page 51.

- Click each tab in the Deviation Viewer to see the values from other dimensions that intersect with the deviation.

The screenshot shows a window titled "Deviation Viewer" with the subtitle "Profit, Actual, Television". It contains a table with the following data:

	Jul	Aug	Sep
New_York	292	-274	472
Boston	396	449	588
Chicago	-39	567	466

At the bottom of the window, there are three tabs: "Product x Market", "Market x Year", and "Product x Year". Below the tabs are three buttons: "Open Spreadsheet", "Close", and "Help".

Figure 10. Deviation Viewer, Market by Year view

When you hold the cursor over a red highlighted value, the magnitude and expected values are displayed.

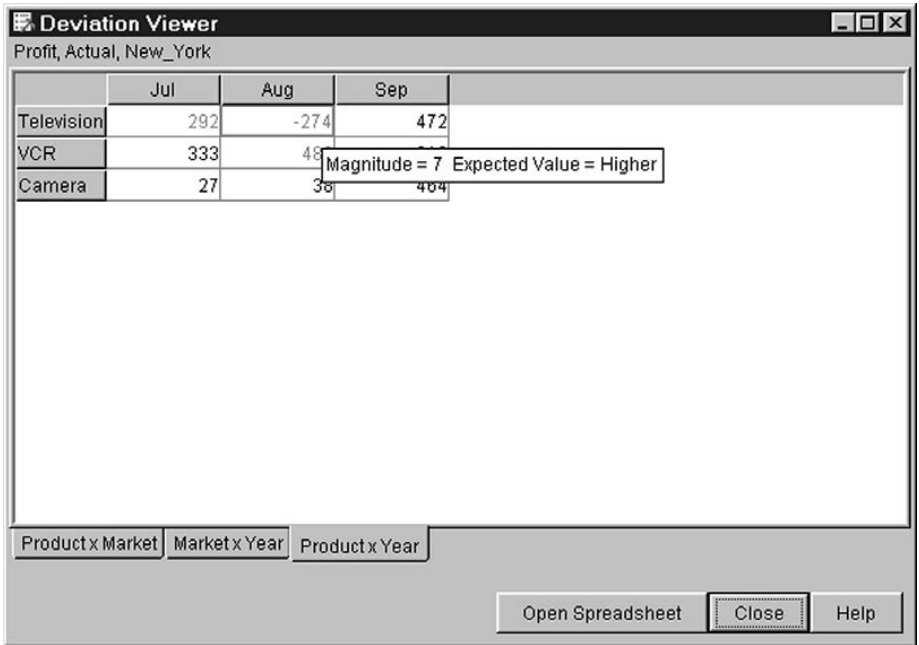

Figure 11. Deviation Viewer, Product by Year view

7. Click the Product x Market tab if this view is not already selected.
8. Click **Open Spreadsheet**.

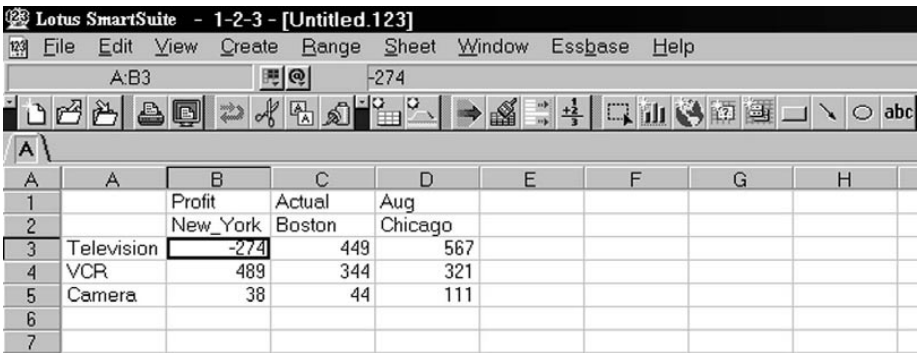

Figure 12. Standard spreadsheet

If you installed the DB2 OLAP Server spreadsheet add-in:

9. Click **Essbase** → **Connect** and select the server where Demo Basic is located.
10. Type your user name and password.
11. Click **OK**.

12. Select Demo Basic from the Application/Database list. You can now use any of the features in the DB2 OLAP Server spreadsheet to investigate or report deviations.

Part 2. Configuring and managing OLAP Miner

Chapter 5. System architecture

OLAP Miner uses a client/server architecture and is connected through TCP/IP or named pipes as shown in Figure 13.

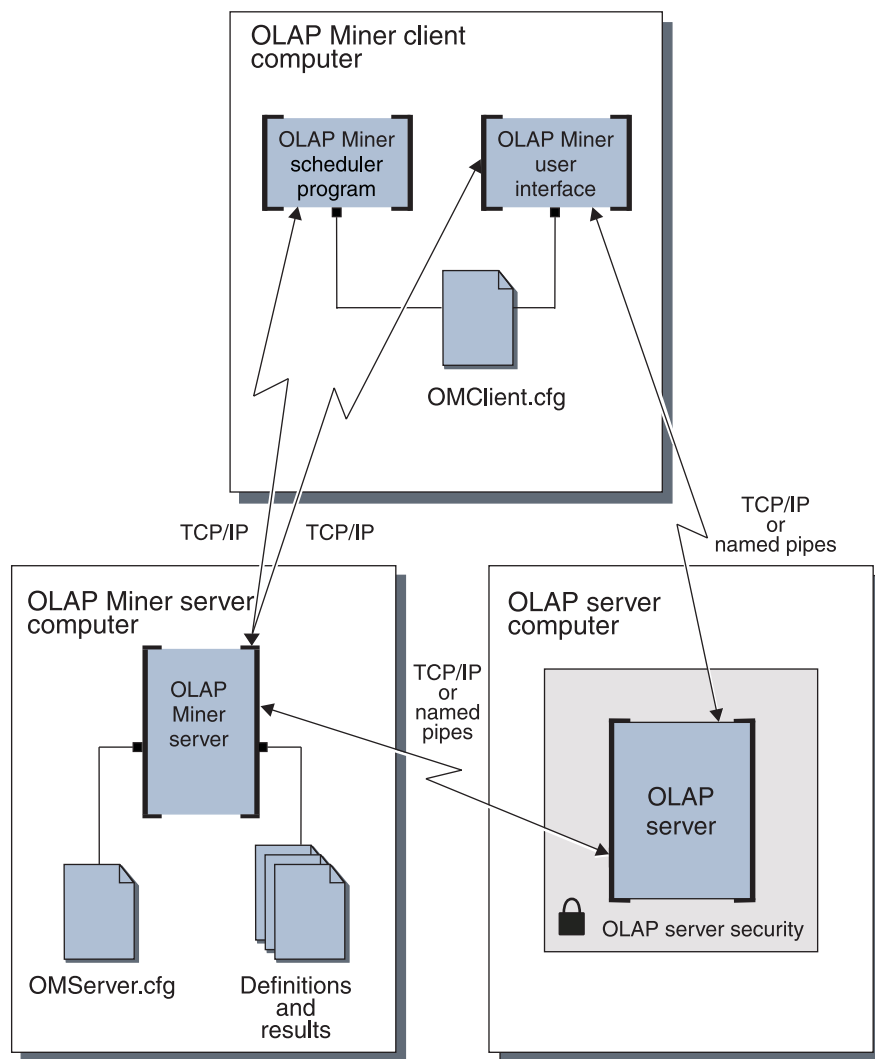

Figure 13. OLAP Miner system architecture

You can configure your client/server system in any of following combinations.

- OLAP Miner client, OLAP Miner server, and OLAP server can all reside on the same computer.
- OLAP Miner client, OLAP Miner server, and OLAP server can all reside on separate computers.
- One or two of these components can reside on one computer, and the third component can reside on a separate computer.

Tip: The OLAP Miner clients use a configuration file (OMClient.cfg) that controls the behavior of the clients. This client file specifies to the OLAP Miner clients on which computer the OLAP Miner server is located. Also, the OLAP Miner server has a configuration file (OMServer.cfg) that controls the behavior of the server. This server file specifies to the OLAP Miner server where the OLAP server component of DB2 OLAP Server is located. The OLAP Miner server can be configured to work with more than one OLAP server if required. The OLAP Miner server stores definition and result files in the file system of its computer.

Chapter 6. Directory structure

OLAP Miner stores deviation detection definition files and deviation results files in the following directory structure:

ARBORPATH\om_data\computeralias\App\Cube\OMD

ARBORPATH

The path where DB2 OLAP Server is installed.

computeralias

An alias name from the OLAP Miner server configuration file (OMServer.cfg) for the target OLAP server computer.

App A DB2 OLAP Server application name that exists on computeralias.

Cube A DB2 OLAP Server database name that exists in App.

OMD An OLAP Miner definition name created by the user.

Restriction: On Windows, the OLAP Miner server does not support the FAT disk format for its data directory. Install the OLAP Miner server only onto an NTFS file system, and do not set the data directory a FAT partition.

Chapter 7. Configuring the OLAP Miner server

The OLAP Miner server manages the deviation detection definitions that are created and run by OLAP Miner users. The server communicates with OLAP Miner clients over TCP/IP and communicates with the OLAP server component of DB2 OLAP Server by using either TCP/IP or named pipes.

The OMServer.cfg file controls the behavior of the OLAP Miner server. This file resides in the ARBORPATH\bin where ARBORPATH is the directory where DB2 OLAP Server is installed.

To configure OLAP Miner server, open the OMServer.cfg file with a text editor and change the appropriate elements.

Here is a sample OMServer.cfg file:

```
<?xml version="1.0"?>
<OMServerConfig>
<olap_server      alias = "OLAP_Machine"
                  address="olapmachine.us.ibm.com"/>
<port             value = "1976"/>
<max_connections  value = "-1"/>
<max_kernel_runs  value = "2"/>
<power_user       value = "CALC"/>
<serverlog        path = "C:\ OMLogs" max_size = "1000000"
                  verbose="LOW"/>
<data_dir         path = "C:\OMData"/>
<!-- This is the directory used to store results files -->
</OMServerConfig>
```

When an element is duplicated, the OLAP Miner server reads only the first iteration of the duplicated element, except where duplicates are allowed. The `olap_server` element is the only element that allows duplicates.

You must have a properly tagged XML file; otherwise, the file will not work. Whenever you change an XML file, ensure that starting `<>` and ending `</>` tags are used correctly. For more information about XML, see Appendix B, "Working with XML files" on page 59.

The following list describes the elements of the server configuration file:

?xml version="1.0"?

A standard required element that declares the XML version of the file. Do not change this element.

OMServerConfig

A standard required element that identifies which component of OLAP Miner these elements apply to. Do not change this element.

olap_server

Information about the computer where the OLAP server component of DB2 OLAP Server is located with which OLAP Miner will communicate. You can repeat this element to allow OLAP Miner to work with multiple OLAP servers. This element has two attributes:

address

The name or IP address of the computer where the OLAP server is installed.

alias The alias name for the computer. This name is displayed in the OLAP Miner client to the user. It is also used when the directory structure is created to store OLAP Miner files. Do not change the alias after definitions are created for that OLAP server, unless you also change the corresponding directory name in the file system.

port The port number that OLAP Miner server uses to listen for requests from any OLAP Miner client. The default value is 1976. This must match the port number that is specified in the OLAP Miner client configuration file. This element is optional.

max_connections

The maximum number of connections that the OLAP Miner server allows. The default value is -1, which indicates the maximum number of connections is controlled by the number of connections allowed to the OLAP server. This element is optional.

max_kernel_runs

The maximum number of mining runs that the OLAP Miner server allows. The default value is 2. This element is optional.

power_user

Indicates the authority level users must have to a cube before they can work with deviation detection definitions that are associated with that cube. If users do not have this level of authority, they cannot create, edit, copy, rename, delete, or run a deviation detection definition. The default value is CALC. This element is optional.

The possible values for this element are:

READ Users with read-only access to a database can work with deviation detection definitions.

WRITE

Users with read and write access to a database can work with deviation detection definitions.

CALC Users who can calculate data can work with deviation detection definitions.

serverlog

Specifies information about the OLAP Miner server log. This element and any of its attributes are optional. It has the following attributes:

path The path for the OLAP Miner server log file. The default value is ARBORPATH where ARBORPATH is the directory where you installed DB2 OLAP Server, and the name of the server log file will be OMServer.log.

max_size

The maximum size of the log in bytes. The default is 1000000 bytes.

verbose

Controls the amount of information that the server writes to its log file. The possible values are HIGH, MEDIUM, LOW, or NONE. The default value is LOW, which allows the least amount of log information.

data_dir

The path that designates where the OLAP Miner server stores mining definition files and results files. The default value is ARBORPATH\om_data. You should not change this element after you create deviation detection definitions. This element is optional.

My comment

The configuration file can contain comments that must use the following format:

```
<!-- My comment -->
```

where My comment is the comment text.

Requirement: Information that is *not* surrounded by quotation marks in XML files is case sensitive. Do not change the case of elements in the configuration file.

For information about configuring your system for optimal performance, see Chapter 13, “Improving performance and scalability” on page 47.

Chapter 8. Starting and stopping the OLAP Miner server on Windows and AIX

You can run the OLAP Miner server on Windows or AIX.

Starting the OLAP Miner server on Windows

You can start the OLAP Miner server from the Windows Start menu or from a command line.

To start the OLAP Miner server from the Windows Start menu:

1. Ensure that the OLAP server component is started. See the *OLAP Setup and User's Guide* for information about starting the OLAP server component.
2. Click **Start** → **Programs** → **IBM DB2 OLAP Server 7.1** → **OLAP Miner Server**.

To start the OLAP Miner server from a command line:

1. Ensure that the OLAP server component is started. See the *OLAP Setup and User's Guide* for information about starting the OLAP server component.
2. At the command line, type `omserv` and press Enter.

Tip: On Windows 2000, the server freezes if the Quick Edit mode setting for the MS-DOS prompt is turned on. To prevent this, turn off the setting by using the command line properties window.

Starting the OLAP Miner server on AIX

On AIX, you can run the OLAP Miner server in the background or the foreground.

To start the OLAP Miner server on AIX and run it in the foreground:

1. Ensure that the OLAP server component is started. See the *OLAP Setup and User's Guide* for information about starting the OLAP server component.
2. Open a command line.
3. At the command line, type `omserv.sh` to start the OLAP Miner server and to display server activity on the output console.

To start the OLAP Miner server to run in the background and to write server activity to an output file, repeat Step 1 and Step 2. Then type the following command:

```
omserver.sh -b filename &
```

The `-b` parameter disables console input so that no commands can be entered, and it redirects console output to a file name. If the file cannot be opened or if it is not specified with `-b`, then the server exits with a return code of `-1`.

Stopping the OLAP Miner server on Windows and AIX

On Windows or on AIX running in the foreground, to stop the OLAP Miner server, type `exit` at the command line. Then press Enter.

On AIX, to stop the OLAP Miner server when it is running in the background:

1. Find the process ID for the `OMServer.jar` Java application. For example, type

```
ps -ef | grep OMServer.jar
```
2. End the process by using the returned process ID and the `kill` command. Do not use the `kill -9` command. If you do, the OLAP Miner server does not clean up any resources that it is using.

Chapter 9. Configuring the OLAP Miner client

There are two OLAP Miner clients: the OLAP Miner client application and the definition run program. The OLAP Miner client application is a graphical interface that allows the user to:

- Create, manage, and run deviation detection definitions
- View results after mining runs

The run definition utility is a program that can schedule a mining run from a client computer by using a scheduler of your choice.

To edit the values in the client configuration file, open the OMClient.cfg file with an XML or text editor and change the appropriate elements. See Appendix B, "Working with XML files" on page 59 for more information about using XML.

Requirement: You must stop and restart the OLAP Miner client application before the client configuration file can be read.

Here is a sample OMClient.cfg file:

```
<?xml version="1.0">
<OMClientConfig>
<olap_miner_server      value = "ominer.us.ibm.com/>
<port                   value = "1976"/>
<language               value = "EN_US"/>
<spreadsheet_path      value = "C:\lotus\123\123w.exe"/>
<sup_missing_rows      value = "true"/>
<!-- This element tells Miner to display a text string instead of #Missing -->
<missing_text           value = "Not Applicable"/>
<clientlog              path = "C:\OMLogs" max_size = "1000000" verbose =
                        "LOW"/>
</OMClientConfig>
```

The following list describes the elements in the client configuration file:

?xml version="1.0"?

A standard required element that declares the XML version of the file. Do not change this element.

OMClientConfig

A standard required element that identifies to which component of OLAP Miner these elements apply. Do not change this element.

olap_miner_server

Name or IP of the computer where the OLAP Miner server is installed. If the element is missing the default value is localhost. This element is optional.

port The port number that the OLAP Miner client uses to communicate with the OLAP Miner server. The default value is 1976. This port number must be the same as the port number that is specified in the OLAP Miner server configuration file. This element is optional.

language

The language that is chosen at installation time.

spreadsheet_path

The absolute path to where your spreadsheet is located. This path is used to locate your spreadsheet when you click the **Open Spreadsheet** push button in the Deviation Viewer window. If the spreadsheet path element is omitted, OLAP Miner reads the location of the spreadsheet from the Windows registry. This element is optional.

sup_missing_rows

Indicates whether the OLAP Miner Deviation Viewer hides rows that have all missing values. The possible values for this Boolean element are True and False. The default value is True. This element is optional.

missing_text

The text string that is displayed in the OLAP Miner Deviation Viewer in place of missing values that are returned from DB2 OLAP Server. The default is to display whatever is returned by the OLAP server when the Deviation Viewer retrieves data. This element is optional.

clientlog

Creates an OLAP Miner client log file. This parameter is optional. It has the following parameters:

path This is the path and name of the OLAP Miner client log file. The default is %ARBORPATH%\OMClient.log.

max_size

This is the maximum size in bytes of the log. The default is 10000000 bytes.

verbose

This controls the amount of information that the server writes to its log file. The possible values are HIGH, MEDIUM, LOW, or NONE. The default is NONE, which means no logging takes place.

My comment

Allows you to add comments to the configuration file.

```
<!-- My comment -->
```

where My comment is the comment text.

Restriction: Information that is *not* surrounded by quotation marks in XML files is case sensitive. Do not change the case of elements in the configuration file.

Chapter 10. OLAP Miner server commands

You can enter the commands at the command line where you started the OLAP Miner server.

The following commands are available for OLAP Miner server:

Table 1. OLAP Miner server commands

help	Displays help on the available commands.
exit/quit/shutdown	Any of these three commands terminates all OLAP Miner server kernel processes, all connections to OLAP Miner clients, and the OLAP Miner server session.
list runs	Provides a list of deviation detection definitions that are currently running.
list connections	Provides a list of current client connections to the OLAP Miner server.
close connection <n>	Closes the <n> connection from the list of existing connections that are given by list connections.
list config	Prints the current server configuration.
sync olap <olap_alias> <user> <password>	Synchronizes the OLAP Miner files with the current DB2 OLAP Server that is identified by olap_alias. The user ID and password must be for a supervisor user for the DB2 OLAP Server that is identified by olap_alias. Enter the sync olap command when applications or databases are deleted from the DB2 OLAP server system. The command ensures that all OLAP Miner files have a corresponding application and database combination on the DB2 OLAP Server system. It deletes any OLAP Miner files that do not have a corresponding application and database combination.

Chapter 11. OLAP Miner mining run program

If you want to run deviation detection definitions after regular business hours or schedule regular mining runs, you can use IBM DB2 UDB Data Warehouse Center™ Version 7 or the tool of your choice to run deviation detection definitions. To run a deviation detection definition within the DB2 UDB Data Warehouse Center, you need to specify the `omrundef` utility command as a user-defined program in the Data Warehouse Center.

For more information, see the *IBM DB2 UDB Data Warehouse Center Administration Guide*.

Use double quotation marks around any parameter that is two or more words. For example, if you use a deviation detection definition that is called *Sales Analysis*, ensure that you type the name as "Sales Analysis" when you use the `omrundef` program.

Parameters such as application, database, or definition are case sensitive.

Restriction: Commands on Windows 95, 98, and ME can be a maximum of 128 characters. If you specify all the parameters of the `omrundef` command, you might exceed the character limit. To use the `omrundef` on Windows 95, 98, and ME, use the minimum number of parameters and characters. For example, instead of specifying optional parameters such as `-use` and `-mode`, omit these parameters and use the default action.

The `omrundef` program uses the following parameters:

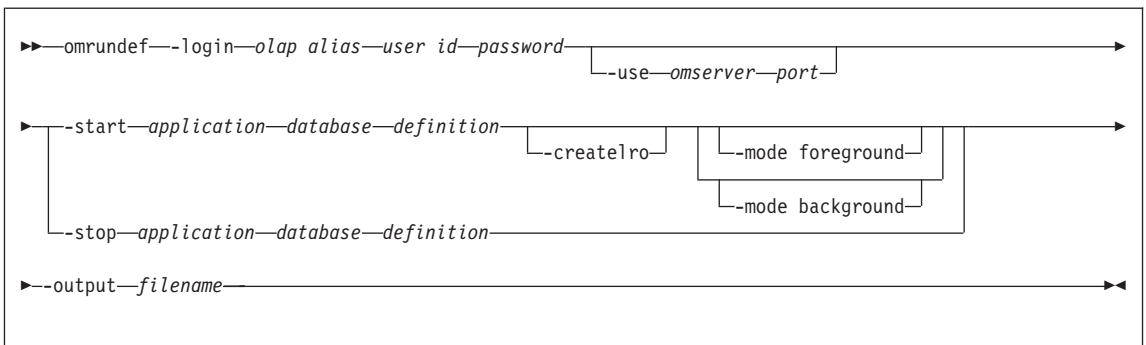

-login Provides login information about the OLAP server to which you are connected. This parameter has three attributes:

olap alias

An alias name for the OLAP server where the target application and database exist. The alias is an alias from the OLAP Miner server configuration file (OMServer.cfg).

user ID

The user ID on the OLAP server to which you want to connect.

password

The password for the user ID.

-use Use this parameter if you do not want to use the connection information that is provided in the OMClient.cfg file. This parameter is optional. This parameter has two attributes:

omserver

The name or IP Address of the computer where the OLAP Miner server is installed.

port The port that the OLAP Miner server is configured to listen on.

-start The start and stop parameters are mutually exclusive. The start parameter provides information to identify the deviation detection definition to run. This parameter has three attributes:

application

The application on the OLAP server that contains the database to be mined.

database

The database to be mined.

definition

The deviation detection definition to be run.

-createlro

Indicates that a set of linked reporting objects will be created in the source cube. One linked reporting object will be created for each deviation that is detected during the current deviation detection definition run. Before creating linked reporting objects, OLAP Miner removes any linked reporting objects that are associated with that deviation detection definition. This parameter is optional.

-mode Indicates the type of run to be performed. The default is foreground. This parameter is optional. This parameter has two attributes:

background

Indicates that the deviation detection definition runs asynchronously.

foreground

Indicates that the deviation detection definition runs synchronously.

-stop The start and stop parameters are mutually exclusive. The stop parameter provides information about which deviation detection definition run to stop. This parameter has three attributes:

application

The application on the OLAP server that contains the database that is being mined.

database

The database that is being mined.

definition

The deviation detection definition to be stopped.

-output

Provides a file name where the output log information from the `omrundef` command is written. This parameter is optional.

filename

The file name where the output text is written.

Examples of scheduled mining runs

The following examples show some of the ways that you can use the mining run program to schedule deviation detection definition runs.

Enter the following command on one line.

Example 1

```
omrundef -login "OLAP Computer" user1 password -start  
Sample Basic "Sales Analysis"
```

This command logs on as `user1` with the password as `password`. This user logs on to the OLAP server that is running on the computer that is identified by the alias `OLAP Computer`. This alias must exist in the `OMServer.cfg` file. It then starts running the *Sales Analysis* deviation detection definition on the *Basic* database in the *Sample* application. By default the command is executed in the foreground (synchronously).

Example 2

```
omrundef -login "OLAP Computer" user1 password -start  
Sample Basic "Sales Analysis" -mode background
```

This command does the same as Example 1, but it runs the deviation detection definition in the background (asynchronously).

Example 3

```
omrundef -login "OLAP Computer" user1 password -stop  
Sample Basic "Sales Analysis"
```

This command stops the mining run that was started by the previous command.

Example 4

```
omrundef -login "OLAP Computer" user1 password -start  
Sample Basic "Sales Analysis" -createlro -output output.txt
```

This command starts the same deviation detection definition run, but it also requests that linked reporting objects (text notes) are written to the source OLAP database for each of the deviations that are detected by the deviation detection definition run. It also writes any output text to a file that is called output.txt.

After you schedule a deviation detection definition run, the program returns one of the following codes:

Table 2. Mining run program return codes

Return code	Description
0	Success
1	There is an error in the given parameters
2	Network error
3	Login error
4	An error occurred while performing the operation on the server

Chapter 12. Access privileges

OLAP Miner relies on DB2 OLAP Server to authorize its users to access servers, applications, and cubes.

When you log on to the OLAP server from the OLAP Miner client application, your user ID and password are passed to the OLAP Miner server. The OLAP Miner server uses that information to log on to the OLAP server, and any subsequent requests to the OLAP server are performed with that connection.

You can configure OLAP Miner to allow only users with certain privileges to create, manage, and run deviation detection definitions. You might want to do this if you have *power users* in your organization who are comfortable working with OLAP outlines, and you want to restrict the ability to work with definitions to those users.

You might also want to control which users can run definitions because running deviation detection definitions can affect the performance of the OLAP Miner server. You can control this type of access by using the `power_user` element of the `OMServer.cfg` file. This allows you to control the access that a user must have to a cube before that user is allowed to work with and run deviation detection definitions. For more information about the possible settings for the `power_user` element, see Chapter 7, “Configuring the OLAP Miner server” on page 29.

Chapter 13. Improving performance and scalability

By following the guidelines in this chapter, you can improve the performance and scalability of OLAP Miner.

Improving performance

The size of the subcube that is used in a deviation detection definition affects the amount of computing resources your server needs to complete a definition run. Creating deviation detection definitions with very large subcubes could take several hours to complete. You should be aware of the size of your cubes before you run a deviation detection definition.

You can schedule definition runs after regular business hours by using the `omrundef` program that is provided with OLAP Miner. See Chapter 11, “OLAP Miner mining run program” on page 41 for information about scheduling definition runs.

You should use OLAP Miner on a computer with a similar configuration as the OLAP server component.

Ensure that the OLAP server component is tuned for optimum performance. See the *OLAP Setup and User's Guide* for information about tuning DB2 OLAP Server.

Important:

Set the retrieval buffer size to **2 KB**, which is lower than the OLAP server default setting, for each database that you want to mine. You must set this retrieval buffer size for each, separate cube. It cannot be set globally. This setting can significantly reduce the computing time for deviation detection definitions. For information about setting retrieval buffer size, see the *OLAP Database Administrator's Guide, Volume 2, Version 7*.

Improving scalability

Increase the temporary file space by changing the location of all data files and temporary files. OLAP Miner requires approximately the same size of the subcube for temporary file space. Use the `<data_dir path =/>` element of the `OMServer.cfg` file to change the directory. See Chapter 7, “Configuring the OLAP Miner server” on page 29 for more information about configuring the server.

For AIX, ensure that the file system that is specified is large file enabled.

Chapter 14. Back up and recovery

The OLAP Miner server stores deviation detection definitions and any results that are produced by running those definitions in the file system. The files are stored in a directory structure described in Chapter 6, "Directory structure" on page 27.

Back up these files if you want to restore your OLAP Miner environment after a major system problem. You can back up all files under the ARBORPATH\om_data directory. Back up OLAP Miner files whenever you back up DB2 OLAP Server files.

To recover from an error, restore the files that you backed up to the file system.

Appendix A. How OLAP Miner works

DB2 OLAP Server provides flexible and powerful query capabilities. These functions are typically used to search for and report on useful facts in multidimensional data. However, OLAP databases can often hold so much data that it is impossible to search all areas of the cube for useful information. OLAP Miner helps with this data exploration problem by using a sophisticated algorithm to search cubes for extraordinary values or *deviations*. A deviation is defined as a value in the cube that differs significantly from its expected value.

You do not need to understand the concepts that are explained in this chapter to use OLAP Miner effectively. If you want to start creating deviation detection definitions to find deviations in your data, see “Before you create deviation detection definitions” on page 3 in this book or see the OLAP Miner online help.

The OLAP Miner algorithm

OLAP Miner uses a sophisticated statistics-based multidimensional algorithm that scans all the cell values in a specified area (subcube) of an OLAP cube for deviations. A value is considered a deviation if it is significantly different from the expected value. The OLAP Miner algorithm calculates the expected value of a cell based on its position in the cube, and the algorithm combines contributions from all dimensions to which the cell belongs. OLAP Miner lists deviations, presents various views of each deviation, and quantifies the magnitude of each deviation with respect to other deviations in the same cube.

The following simplified example shows how OLAP Miner finds deviations in OLAP cubes.

Member Only or Member and Descendants selections

For this example, we will select a four-dimensional OLAP cube as shown in Figure 14 on page 52. Our goal is to find deviations in the sales data from that cube. The cube contains the following dimensions: Accounts, Year, Market, and Product. The Sales data (from the Accounts dimension) will be searched for deviations in the context of the other three dimensions.

To find deviations, we first create a deviation detection definition. To create a deviation detection definition, we select a member from each dimension and specify it as Member Only or Member and Descendants. These selections

specify how far down in the hierarchy of the dimension OLAP Miner will search for deviations.

Accounts dimension

Sales (member)	Member Only
Costs (member)	
Profit (member)	

Year dimension

2001 (member)	Member and Descendants
1st Qtr. (descendant)	
2nd Qtr. (descendant)	
3rd Qtr. (descendant)	
4th Qtr. (descendant)	

Market dimension

North America (member)	Member and Descendants
Chicago (descendant)	
Dallas (descendant)	
New York (descendant)	
San Francisco (descendant)	

Product dimension

Soft Drinks (member)	Member and Descendants
Cola (descendant)	
Rootbeer (descendant)	
Lemon Lime (descendant)	
Grape (descendant)	

Figure 14. Specifying each member in the cube as Member Only or Member and Descendants to create a deviation detection definition

For this analysis, we will select only the Sales member as Member Only from the Accounts dimension. From the Year, Market, and Product dimensions, we will select all first-generation members as Member and Descendants. The target member, in this example Sales, must be selected as Member Only so that OLAP Miner does not calculate different units of measure. Also, we want to isolate the sales figures from cost and profit figures. See “Before you create deviation detection definitions” on page 3 for information about selecting members for deviation detection definitions.

If you change a subcube even slightly, you might see more or fewer deviations and possibly very different magnitude values. The OLAP Miner algorithm results depend on which dimensions you select and how many levels or generations those dimensions include. You might see very different results (deviations and magnitude) simply by selecting more or fewer members of a dimension.

The subcube

After we specify all members in the cube as either Member Only or Member and Descendants, OLAP Miner collects the data to form the subcube. The subcube contains sales data referenced by the members from Year, Market, and Product. Specifying members as either Member Only or Member and Descendants creates the deviation detection definition. Collecting the data together creates a subcube. A deviation detection definition is similar to an OLAP outline, and a subcube is similar to a small database. Although the subcube is similar to a small database, it is not created as a DB2 OLAP Server cube (database). Rather, the data is processed internally by the OLAP Miner server.

By specifying a member from the Accounts dimension as Member Only, we target that member to be mined for deviations. Remember that a value is deviant only in comparison to the values that surround it in the subcube. As shown in Figure 15 on page 54, OLAP Miner specifically analyzes Sales in the context of the other dimensions (Year, Market, and Product).

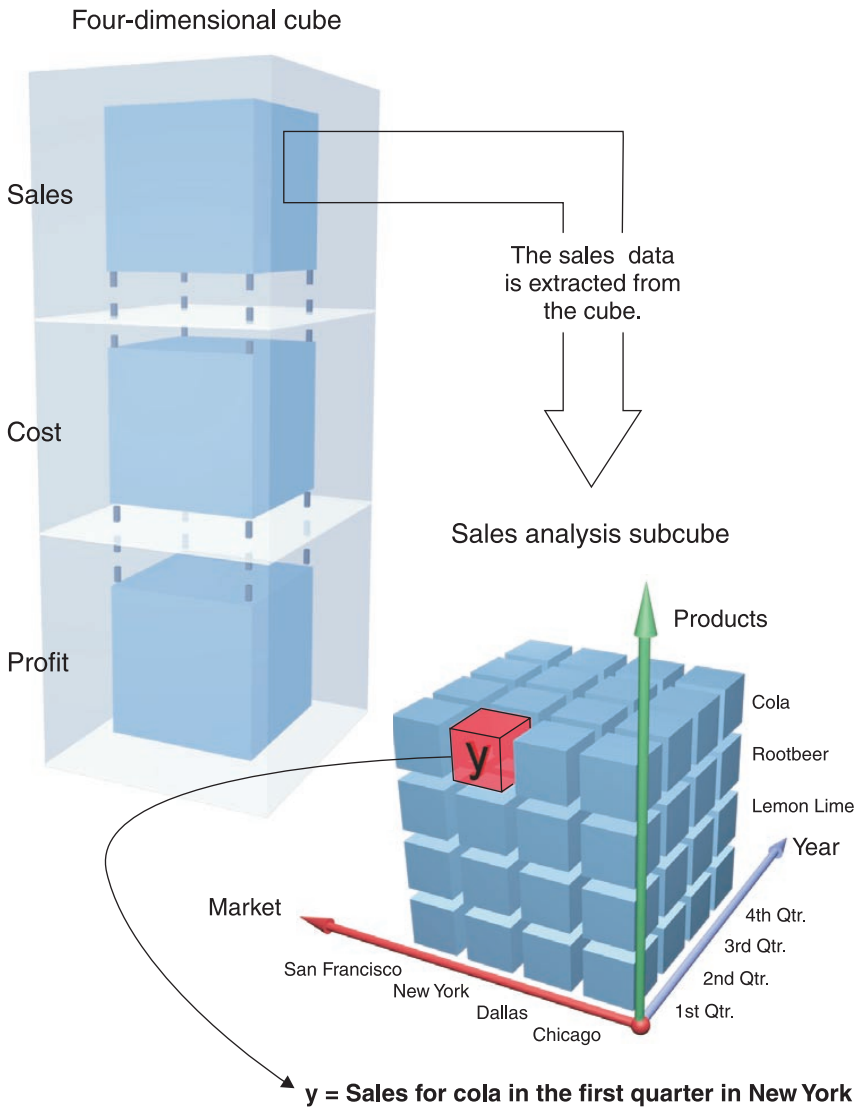

Figure 15. Creating a subcube from four-dimensional source cube

The expected value of cell in the subcube

To determine if a cell value is a deviation, OLAP Miner must compute the expected value for every cell in the subcube. The expected value for each cell is compared to the actual value of each cell to determine if the cell value is a deviation and to what extent it is deviant. Figure 16 on page 55 shows how one expected value for cell y is calculated. Each view represents the

intersection of cell y with the other dimensions in the subcube, and each view contributes to the expected value for cell y .

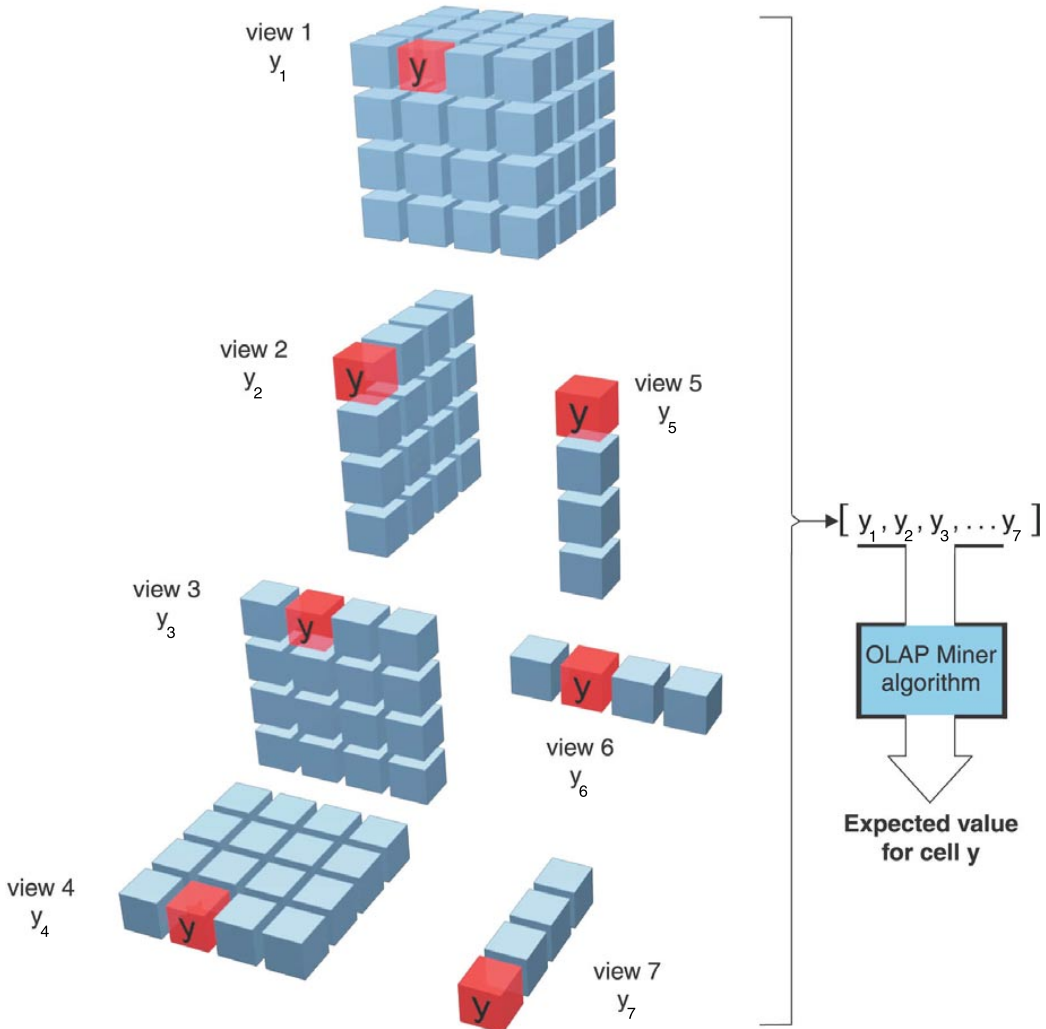

Figure 16. OLAP Miner computing the expected value for a single cell y

The magnitude of the deviation

In simple terms, OLAP Miner scales the absolute difference between the actual cell value and the expected cell value to show the magnitude of the deviation. Higher magnitude values show more significant, or important, deviations. OLAP Miner uses a scaled system so that it can find deviations more accurately in extreme ranges of values, including negative and positive value ranges.

More specifically, after the expected value is calculated, the absolute difference between the actual and the expected value is calculated. This absolute difference is called the *residual*. OLAP Miner considers any cell in which the residual is relatively large to be a deviation. However, a statistically valid definition of *relatively large* is required, so the residual value is divided by the associated standard deviation for that cell.

For example:

Residual = |Expected cell value - Actual cell value|
 Associated Standard Deviation is
 $R1^2 + R2^2 + R3^2 \dots$ (R = residuals for all selected cells in the subcube) = X
 Associated Standard Deviation = \sqrt{X} /number of cells in the subcube
 Standardized Residual = Residual/Associated Standard Deviation

Because OLAP cubes can contain extreme ranges of values, including negative and positive values, the OLAP Miner algorithm standardizes the residual value. A standardized residual is required because mere residual values can be misleading and might not be useful for analysis. Also, a standardized residual can accommodate extreme values without allowing those values to skew the other values in the subcube. This process of standardization acts as a normalizer. If this calculated standardized residual is higher than a defined threshold for that cube, the value of the cell is considered a deviation.

OLAP Miner does not use a single absolute scale to measure magnitude. Magnitude is scaled for each subcube individually. Therefore, you cannot compare the magnitude values of one subcube to another subcube.

Examples of deviant values in a subcube

The following examples use numeric values to show how OLAP Miner finds deviations in a subcube.

Example 1

Here is a simple two-dimensional subcube:

	JAN	FEB	MARCH	APRIL	MAY
A	11	12	18	13	13
B	17	15	17000	13	14
C	13	13	15	14	17
D	17	12	16	16	14
E	17	18	15	14	12
F	16	12	17	14	18

OLAP Miner recognizes 17000 as a deviant value with an expected value that is much lower than the actual value. The OLAP Miner algorithm determines that this deviation has a magnitude of 5.

Example 2

What would happen if we added a 500 value to this cube?

	JAN	FEB	MARCH	APRIL	MAY
A	11	12	18	13	13
B	17	15	17000	13	14
C	13	13	15	14	17
D	17	12	16	16	500
E	17	18	15	14	12
F	16	12	17	14	18

Some mining tools might point out that only the 17000 value is deviant.

If the subcube in this example had an additional entry of 500, OLAP Miner would report both the 500 value and the 17000 value as deviations. The algorithm does not allow the 17000 value to dominate the deviation mining process. If OLAP Miner did not use certain transformations for the data, the 500 value might not be highlighted as a deviation.

In addition, this transformation causes OLAP Miner to focus on the relative differences in the cell value during the analysis, which matches the way that business analysts examine business data.

Example 3

In the following example, the expected value for a cell (D, APRIL) is calculated as higher than the actual value.

The difference between the expected value and the actual value is large enough for this value to be flagged as a deviation.

	JAN	FEB	MARCH	APRIL	MAY
A	11	12	15	18	13
B	13	15	13	19	14
C	13	13	14	17	14
D	18	19	18	18	19
E	11	12	12	17	12
F	15	15	16	18	16

OLAP Miner finds the cell (D, APRIL) as a deviation with a magnitude of 4. The expected value of the cell is higher because APRIL has slightly higher values (A, B, C, E, and F), but the values for D are flat.

The cell (D, APRIL) does not appear deviant if you look only at row D and column APRIL. However, if you compare the cell (D, APRIL) to all other values in this subcube, then you see that this cell value is deviant.

Appendix B. Working with XML files

OLAP Miner uses XML (extensible markup language) files to configure the client and the server. This section describes some guidelines about editing XML files. This document is not meant to be an exhaustive description of XML.

You can use any text editor or most XML editors to edit an XML configuration file.

Restriction: Do not use the LPEX editor for OLAP Miner configuration files. LPEX adds an illegal end-of-file character to XML files.

Use the following guidelines when you edit XML files:

- Ensure that you specify the xml version on the first line of the file. The first line of the file cannot be empty.
- Elements in XML are case sensitive. For example, <Para< and <para< are two different elements.
- All elements that are not empty require start and end tags except <?.
- Empty elements (elements with no start tags and end tags) must have a forward slash before the greater-than sign. Example: <port value = "1976"/>.
- Always use double or single quotation marks around attribute names.
- Tags must be correctly nested: close first what you opened last. Example: write tags like this <I>test</I>, not like this <I>test</I>>.
- You cannot use the following symbols in an XML document:
 - < (use < instead)
 - > (use > instead)
 - & (use & instead)
 - ' (use ' instead)
 - " (use " instead)

Appendix C. OLAP Miner client and server messages

-999 **An internal error occurred. The OLAP Miner Server might not be running. This application will be shut down.**

Explanation: An error occurred within the OLAP Miner server.

User Response: Use the information in the message to diagnose the problem.

0 **The operation was successful.**

Explanation: The operation was successful.

User Response: No action is required.

2 **Invalid connection state**

Explanation: The OLAP Miner server received an invalid internal request.

User Response: Contact IBM Software Support.

3 **An OLAP Miner server I/O error occurred. Error message = <filename>.**

Explanation: An internal error occurred in the OLAP Miner server. This error might occur if the data directory does not have write access. If you are using the OMRUnDef program, it might be because the parameters you provided are not in the correct case.

User Response: Ensure that write access is available for the data directory and all of its subdirectories. If you are using OMRUnDef, ensure that you provide all parameters in the correct case. If you cannot resolve the problem, contact IBM Software Support.

4 **A client side I/O error occurred. Error message = <filename>.**

Explanation: An internal error occurred in the OLAP Miner client.

User Response: Use the information in the message to diagnose the problem. If you cannot resolve the problem, contact IBM Software Support.

5 **The requested resource <filename> is currently locked.**

Explanation: The resource that you tried to access is locked.

User Response: Ensure that the resource is unlocked. If you cannot resolve the problem, contact IBM Software Support.

6 **OLAP Miner server received an invalid internal request <filename>.**

Explanation: The OLAP Miner server received an invalid internal request.

User Response: Contact IBM Software Support.

7 **The client cannot access the requested resource <filename>.**

Explanation: The client cannot access the requested resource.

User Response: Ensure that you have access authority to the object that you selected.

8 **Invalid client command: <filename>.**

Explanation: An invalid command was issued internally by the OLAP Miner client.

User Response: Contact IBM Software Support.

9 **No server reply was received.**

Explanation: The OLAP Miner server did not reply to an internal client command.

User Response: Contact IBM Software Support.

50 **The connection initialized successfully.**

Explanation: The connection initialized successfully.

User Response: No action is required.

51 **The OLAP Miner internal connection initialization failed.**

Explanation: An internal connection to the OLAP Miner failed to initialize.

User Response: Ensure that the OLAP Miner server is running. If you cannot resolve the problem, contact IBM Software Support.

100 **Invalid OLAP server alias <filename>.**

Explanation: The specified OLAP server alias is invalid.

User Response: Check the OLAP server alias or create the specified OLAP Miner server alias in the server configuration file.

111 **The number of connections exceeds the server limit.**

Explanation: The number of connections exceeds the limit that is specified in the server configuration file.

User Response: Reduce the number of connections to the OLAP Miner server or increase the connection limit that is specified in the server configuration file.

121 **The connection already exists.**

Explanation: The client is already connected to the OLAP Miner server.

User Response: No action is required.

160 **No definitions were found.**

Explanation: There are no definitions.

User Response: Create a definition first and then retry the operation.

172 **Unable to create an empty mining run file.**

Explanation: The server did not receive any content information from the mining run file.

User Response: No action is required.

230 **The mining run is in progress.**

Explanation: The mining run is in progress.

User Response: Wait for the mining run to finish or interrupt the current mining run before starting another mining run.

231 **The mining run cannot start because the number of mining runs in progress exceeds the limit specified in the OLAP Miner server configuration file.**

Explanation: The number of mining runs in progress exceeds the limit specified in the OLAP Miner server configuration file.

User Response: Either increase the max_kernel_runs value in the server configuration file or stop one of the current mining runs.

233 **The output file <filename> cannot be initialized.**

Explanation: Unable to create the output file on OLAP Miner server.

User Response: Check the file system on the server.

250 **The mining run is not in progress.**

Explanation: The specified mining run is not in progress. Therefore, it cannot be stopped.

User Response: No action is required.

251 **The mining run cannot be interrupted.**

Explanation: Interruption of the specified mining run failed

User Response: Try again or wait for the mining run to finish.

270 **No OLAP server aliases are defined.**

Explanation: There are no OLAP server aliases specified in the OLAP miner server configuration file.

User Response: Create alias entries in the OLAP miner server configuration file.

350 **The target definition already exists.**

Explanation: The target definition already exists.

User Response: Repeat the action with a different target definition name.

390 **The mining run is still in progress.**

Explanation: The mining run is still in progress.

User Response: Wait for the mining run to complete.

391 **The mining run failed during execution.**

Explanation: The mining run failed.

User Response: Inspect the error with the Show Progress window.

392 **The run was interrupted.**

Explanation: The mining run was interrupted before its completion.

User Response: No action is required.

500 **An internal error occurred while verifying the XML definition file. The error was<filename>.**

Explanation: An error occurred while processing the XML definition file.

User Response: Contact IBM Software Support.

506 **The outline has more dimensions than specified in the definition.**

Explanation: The saved definition is outdated according to the error message.

User Response: Re-edit the definition and ensure that the saved definition is up to date with the current outline.

507 **The number of dimensions has changed. The current number = <filename>, definition number = <filename>.**

Explanation: The saved definition is outdated according to the error message.

User Response: Re-edit the definition and ensure that the saved definition is up to date with the current outline.

508 **Dimension <filename> no longer exists in the current outline.**

Explanation: The saved definition is outdated according to the error message.

User Response: Re-edit the definition and ensure that the saved definition is up to date with the current outline.

509 **Member <filename> no longer exists in the current outline.**

Explanation: The saved definition is outdated according to the error message.

User Response: Re-edit the definition and ensure that the saved definition is up to date with the current outline.

510 **Member <filename> is no longer a member of dimension <filename>.**

Explanation: The saved definition is outdated according to the error message.

User Response: Re-edit the definition and ensure that the saved definition is up to date with the current outline.

511 **An I/O error occurred. Information returned was <filename>.**

Explanation: An I/O error occurred while processing, possibly because the server is unable to write data into the OM data path.

User Response: Ensure that the data path is not read-only and that write access is allowed for the path.

1200 **Type a new definition name.**

Explanation: The Name field is empty.

User Response: Type a new definition name in the Name field.

1201 **The definition <filename> cannot be deleted. The file might be in use.**

Explanation: The definition cannot be deleted if it is currently in use.

User Response: Ensure that the definition is not in use. If you cannot resolve the problem, contact the system administrator.

1202 **The results file <filename> cannot be deleted. The file might be in use.**

Explanation: The results file cannot be deleted if it is currently in use.

User Response: Ensure that the results file is not in use. If you are unable to resolve the problem, contact the system administrator.

1203 **You cannot delete a server, application, or database.**

Explanation: You cannot delete a server application or database by using OLAP Miner.

User Response: You can delete only definitions and results files if you have authorization.

1204 **Type a user name.**

Explanation: The User name field is empty.

User Response: Type a user name in the User name field.

1205 **Type a password.**

Explanation: The Password field is empty.

User Response: Type a password in the Password field.

1206 **Type a search string.**

Explanation: The Find string field is empty.

User Response: Type a string to search.

1208 **String <filename> not found.**

Explanation: The string was not found.

User Response: Ensure that all words are spelled correctly. Try different keywords.

1209 **No deviations were found.**

Explanation: OLAP Miner did not find deviations in the data that you selected in your definition.

User Response: You can create another definition to search for deviations or edit the definition from which these results were obtained to extend the data to be analyzed.

1210 Invalid encoding value.

Explanation: The character encoding is not supported by Java

User Response: Use a computer that has Java supported character encoding. If you cannot resolve the problem, contact the system administrator.

1211 The linked reporting objects (text notes) were successfully created.

Explanation: The linked reporting objects (text notes) were successfully created.

User Response: No action is required.

1212 The linked reporting objects (text notes) were successfully deleted.

Explanation: The linked reporting objects (text notes) were successfully deleted.

User Response: No action is required.

1213 No linked reporting objects (text notes) were found by OLAP Miner to delete.

Explanation: No linked reporting objects were found by OLAP Miner to delete.

User Response: Linked reporting objects might not have been created for the object selected. Use the Create LROs option before trying to delete them.

1214 The definition <filename> is running. You can view the definition but any changes that you make to the definition will not be saved.

Explanation: You are trying to edit the definition while it is running. The definition cannot be changed while it is running.

User Response: You can view the definition while it is running, but if you want to make changes to it, you must either wait for the run to finish or cancel the run before saving any changes to the definition.

1215 The definition <filename> is running. Any changes that you make will not be saved.

Explanation: You are trying to save a definition while it is running. The definition cannot be changed while it is running.

User Response: You can view the definition while it is running, but if you want to make changes to it, you must either wait for the run to finish or cancel the run before saving any changes to the definition.

1300 Are you sure that you want to delete definition <filename>?

Explanation: Do you want to delete this definition?

User Response: Click Yes to delete the definition permanently or click No to keep the definition.

1302 Are you sure that you want to delete results file <filename>?

Explanation: Do you want to delete this results file?

User Response: Click Yes to delete the results file or click No to keep the results file.

1303 Definition <filename> has changed. This might make the current results files invalid for this definition. Click Yes to delete the current results. Click No to keep the current results.

Explanation: If you change the definition, any current results files will not be appropriate for the new definition. To avoid confusion in the future, you can delete the current results files.

User Response: Click Yes to delete the results

files or click No to keep the results files.

1304 **The mining run that created the results file <filename> returned an error. Delete this results file?**

Explanation: The results file is empty because the mining run returned an error.

User Response: Click Yes to delete the results file or click No to keep it. Normally, you should delete the results file unless you want to keep a record of the failed mining run.

1305 **The mining run that created the results file <filename> was interrupted. Delete this results file?**

Explanation: The results file is empty because the mining run was interrupted.

User Response: Click Yes to delete the results file or click No to keep it. Normally, you should delete the results file unless you want to keep a record of the failed mining run.

1306 **Do you want to create one linked reporting object (text note) for each deviation from the selected results file?**

Explanation: Do you want to create one linked reporting object for each deviation?

User Response: Click Yes to create one linked reporting object (text note) in the source database for each deviation in the results file or click No to cancel.

1307 **Do you want to delete all linked reporting objects (text notes) added to the <filename> database by OLAP Miner for the <filename> definition?**

Explanation: Do you want to delete all linked reporting objects that were added to this database?

User Response: Click Yes to delete all linked reporting objects (text notes) added to the

database for the selected definition or click No to keep the linked reporting objects.

1308 **Do you want to delete all linked reporting objects (text notes) added to the <filename> database by OLAP Miner?**

Explanation: Do you want to delete all the linked reporting objects that were added to this database?

User Response: Click Yes to delete all linked reporting objects (text notes) added to the database or click No to keep the linked reporting objects.

1400 **Error in loading the client configuration file. Unable to start the parser. Information returned was <filename>.**

Explanation: An error has occurred while loading the client XML configuration file.

User Response: Correct the configuration file and retry.

1402 **Error in loading the client configuration file. Invalid value <filename> for tag <filename>.**

Explanation: An error has occurred while loading the client XML configuration file.

User Response: Correct the configuration file and retry.

1500 **The default browser cannot be located in the registry. Ensure that you have registered a default browser for loading html files.**

Explanation: The registry does not contain information about the default browser. The key HKEY_CLASSES_ROOT.html in the registry does not contain the reference to the default browser.

User Response: Open up a browser and configure it to be the default browser.

1502 **The default browser command <filename> located in the registry no longer exists. Reinstall the browser or configure another browser as the default browser.**

Explanation: A default browser executable was located in the registry, but it no longer exists.

User Response: Reinstall the browser or configure another browser as the default browser.

2000 **An internal error occurred while creating the Table Model for the Deviation Viewer. The error was <filename>.**

Explanation: Errors occurred during processing.

User Response: Contact IBM Software Support.

2001 **The spreadsheet failed to open. OLAP Miner could not find a spreadsheet program on your computer. Either install a spreadsheet or specify in the OMClient.cfg file the location of your spreadsheet. OLAP Miner issued the command <filename>.**

Explanation: OLAP Miner failed to open the spreadsheet from the Deviation Viewer. Initially, OLAP Miner tries to run the spreadsheet command specified in the OMClient.cfg file. If a command is not specified in the file, OLAP Miner searches the Windows registry for either Excel or Lotus 1-2-3 and runs whichever program is found.

User Response: Ensure that Excel or Lotus 1-2-3 is installed or that the OMClient.cfg file is configured properly.

2002 **Report script returned no data for table "{0}".**

Explanation: The report script did not return any data.

User Response: The members associated with the deviation might not have any data associated

with them, or the user has no access to the data. Ensure that your database is loaded with data and it is calculated, and that the user has access to the data.

2003 **A null deviation was passed to the Deviation Viewer.**

Explanation: An internal error occurred in the OLAP Miner Deviation Viewer.

User Response: Contact IBM Software Support.

2004 **The deviation value displayed in the report does not match the value contained in the results file. The data in the OLAP database might have been updated since the results were produced. Run the deviation definition again to create a new results file.**

Explanation: The deviation results value does not match that of the value extracted from the current database. The results file might be outdated.

User Response: Run the definition again to create new results.

2005 **Columns truncated.**

Explanation: The table displayed in the viewer truncated some data to make the information easier to view.

User Response: To view the truncated data, open the spreadsheet from the Deviation Viewer and zoom out and in again on the dimensions to retrieve the missing values.

2006 **Rows truncated.**

Explanation: The table displayed in the viewer truncated some data to make the information easier to view.

User Response: To view the truncated data, open the spreadsheet from the Deviation Viewer and zoom out and in again on the dimensions to retrieve the missing values.

2007 Rows and columns truncated.

Explanation: The table displayed in the viewer truncated some data to make the information easier to view.

User Response: To view the truncated data, open the spreadsheet from the Deviation Viewer and zoom out and in again on the dimensions to retrieve the missing values.

3000 The wizard cannot start because initialization did not complete successfully.

Explanation: Wizard initialization failed, possibly because the outline API failed to initialize.

User Response: Ensure that the application/database that you are accessing is running on a DB2 OLAP Server system that is at the same release level as your OLAP Miner system. Also, ensure that all DB2 OLAP Server environment variables are configured correctly.

3001 The following dimension/member pair no longer exists in the current outline <filename>.

Explanation: The definition contains members that no longer exist in the database outline, possibly because the members were deleted from the outline. Any results files for the definition will now be obsolete.

User Response: Finish editing the definition and run it to create new results and remove the old results.

3002 The following dimension/member pairs no longer exist in the current outline <filename>.

Explanation: The definition contains members that no longer exist in the database outline, possibly because the members were deleted from the outline. Any results files for the definition will now be obsolete.

User Response: Finish editing the definition

and run it to create new results and remove the old results.

3003 The outline does not have any dimensions.

Explanation: The database outline does not contain any dimensions or members. OLAP Miner cannot be used to create a definition.

User Response: Either create dimensions and members in the database or create a definition with a different database.

3004 Type a name in the Name field.

Explanation: The definition Name field of the wizard is empty.

User Response: Type a new name in the Name field to continue.

3005 Type a different name. <filename> is already used.

Explanation: The name entered for the definition is already used in the current database.

User Response: Type a different name that is not being used in the current database.

3006 The file for the <filename> definition did not initialize correctly.

Explanation: The parser could not parse the XML definition file. The file might be corrupted or someone might have edited the file accidentally.

User Response: Check the XML file to ensure that it is a valid XML file. If the file cannot be corrected, delete the definition and create a replacement.

3007 **Definition name <filename> contains an invalid character. Type a different name that does not contain any of these characters: \ / : * ? " < > |.**

Explanation: The definition Name field of the wizard contains at least one invalid character.

User Response: Enter a different name that does not contain one of these characters \ / : * ? " < > |.

3500 **Cannot select members from different generations.**

Explanation: Selection of members from different generations within a dimension is not allowed.

User Response: Select members only from the same generation within a dimension.

3502 **Make a selection from the outline displayed in the left pane.**

Explanation: The Member Only or Member and Descendant button was clicked without a member selected in the left pane.

User Response: Select a member from the left pane and click the button again.

3503 **Shared members cannot be selected. Select the first instance of this shared member instead.**

Explanation: Selection of shared members is not allowed.

User Response: Select only non-shared members to be included in your definition.

3504 **Warning: Member and Descendants selection in the Accounts dimension might produce an invalid analysis.**

Explanation: A Member and Descendants selection in the Accounts dimension is normally inappropriate because it can lead to a definition that compares different types of data, such as an

analysis that compares dollar values and ratio values.

User Response: Make Member and Descendants selections in the Accounts dimension only when the member and all of its descendants contain data of a similar nature.

3506 **Please make a selection from the right pane before clicking Remove.**

Explanation: The Remove button was clicked without a member selected in the right pane.

User Response: Select a member from the right pane and click the button again.

3507 **Make at least one Member and Descendants and one Member Only selection.**

Explanation: The definition makes sense only if there is at least one Member and Descendants and one Member Only selection.

User Response: Make at least one Member and Descendants and one Member Only selection.

3508 **Make at least one Member Only selection.**

Explanation: The definition makes sense only if there is at least one Member and Descendants and one Member Only selection.

User Response: Make at least one Member and Descendants and one Member Only selection.

3509 **Make at least one Member and Descendants selection.**

Explanation: The definition makes sense only if there is at least one Member and Descendants and one Member Only selection.

User Response: Make at least one Member and Descendants and one Member Only selection.

3511 **Type some text to search.**

Explanation: The Find Next button on the Find Member window was clicked with no text entered in the Find What field.

User Response: Type some text in the Find What field.

3512 **Reached the end of the outline.
Press Find Next button to search
from the top of the outline.**

Explanation: Reached the end of the outline, but the search text cannot be found.

User Response: Click Find Next to start searching for the entered text from the top of the outline or click Cancel to cancel the search.

3513 **Text found.**

Explanation: The text string entered was found.

User Response: Click Find Next to look for the next occurrence of the text or click Cancel to cancel the search.

3514 **Warning: Either the selected
member <filename> or one of its
descendants contains a formula.
When a member with a formula is
selected, OLAP Miner can analyze
only the lowest level data
available, and it will not detect
deviations with higher level
members. You can choose to
proceed with the analysis of just
the lowest level data or choose
not to proceed. If you choose not
to proceed, you can edit your
definition to remove selections of
members with formulas. Do you
want to proceed with the lowest
level data analysis?**

Explanation: The current selections have at least one member that contains a formula itself, or it has a descendant that contains a formula. OLAP Miner supports only level-0 analysis for a subcube or definition that contains a formula.

User Response: Click Yes to continue to analyze only level-0 data or click No to remove selections that use formulas.

3515 **Member and Descendants button
is disabled because member
<filename> contains at least one
non-additive member.**

Explanation: The selected member has at least one descendant that uses either the subtract (-), multiply (*), divide (/), or percent (%) operator. These members cannot be included in the definition, so the Member and Descendants selection has been disabled.

User Response: Use Member Only for the selected member or choose a different member.

3516 **Member and Descendants choice
is disabled because member
<filename> is Label-only or it has
Label-only descendants.**

Explanation: The selected member is either a label-only or has at least one descendant that is label-only. The member cannot be used for analysis because it contains only the value of its first child and not the aggregation of all of its descendants.

User Response: Use Member Only for the selected member or select all of its children if possible.

4000 **Cannot connect to server
<filename>. Error message
returned was <filename>.**

Explanation: The progress monitor cannot connect to the server.

User Response: Verify that the server is running and that the max_connections value is not exceeded.

4001 **Cannot log on to the server as
user <filename>.**

Explanation: The progress monitor cannot log on to the server.

User Response: Verify that the OLAP server is running.

4002 The progress monitor cannot connect to OLAP server.

Explanation: The progress monitor cannot connect to the OLAP server.

User Response: Verify that the OLAP server is running.

4003 Unable to read the server error file. Information returned was <filename>.

Explanation: An error has occurred but the error file cannot be retrieved from the server.

User Response: No action is required.

4004 Attempting to interrupt the mining run, please wait...

Explanation: Interrupting the run.

User Response: Wait.

4005 The mining run was interrupted.

Explanation: The run was interrupted.

User Response: No action is required.

4006 An error occurred while interrupting the mining run. Information returned was <filename>.

Explanation: General error.

User Response: No action is required.

4007 Unable to retrieve the status file from the server.

Explanation: A communication error occurred while retrieving the status file from the server.

User Response: No action is required.

4008 Waiting for mining run to start, please wait...

Explanation: Waiting for the kernel to start on the server.

User Response: Wait.

4009 The mining run ended.

Explanation: The mining run ended.

User Response: No action is required.

5000 No arguments were provided.

Explanation: Requires arguments

User Response: Supply arguments.

5001 The command <filename> was issued with <filename> parameters, expected <filename>.

Explanation: The number of parameters for the command was not the expected number.

User Response: Ensure that the command was issued with the correct parameters.

5004 The port <filename> is not numeric.

Explanation: The port is not given in numeric format.

User Response: Specify a valid port number.

5007 The arguments of -mode <filename> are unknown. Only "foreground" and "background" are supported.

Explanation: The mode specified is unknown.

User Response: Specify only foreground or background.

5010 **Unknown argument <filename> issued.**

Explanation: An unknown argument was issued.

User Response: Check the spelling of the argument and ensure that it is a valid argument.

5011 **"-login" must be specified.**

Explanation: You must specify login information through -login.

User Response: Supply the -login switch and its arguments.

5012 **Both "-start" and "-stop" are specified. Specify only one.**

Explanation: You can only specify -start or -stop, not both

User Response: Specify either -start or -stop.

5013 **<filename> is only applicable with "-start" as specified.**

Explanation: The parameter specified is only applicable to -start.

User Response: Specify -mode only with -start.

5014 **You must specify either "-start" or "-stop".**

Explanation: Neither -start nor -stop is specified.

User Response: Specify either -start or -stop.

5015 **There is an error in the given parameters.**

Explanation: There is an error in the given parameters.

User Response: Check the parameters.

5016 **Unable to connect to server.**

Explanation: Unable to connect to OLAP Miner server.

User Response: See the system administrator.

5017 **Starting the mining run...**

Explanation: Starting the mining run.

User Response: No action is required.

5018 **Starting the mining run and waiting for its completion...**

Explanation: Starting the mining run in the foreground.

User Response: No action is required.

5019 **Stopping the mining run...**

Explanation: Interrupting the mining run.

User Response: No action is required.

5020 **An error occurred.**

Explanation: An error occurred.

User Response: No action is required.

5021 **Completed.**

Explanation: The operation completed.

User Response: No action is required.

5023 **Unable to open the output file.**

Explanation: Unable to open the output file.

User Response: Check that the output file has write permission.

5024 **Command <filename> was issued more than once. Remove all duplicates of the command.**

Explanation: A duplicate command was issued.

User Response: Remove all duplicates of the command.

8200 **Processing error: <filename>.**

Explanation: An internal processing error from the OLAP Miner server kernel occurred.

User Response: Contact IBM Software Support.

8210 **Wrong version of the parameter file. The version expected was <filename>.**

Explanation: The version stored in the parameter file is not supported.

User Response: Contact IBM Software Support.

8211 **This algorithm is not supported <filename>.**

Explanation: The OLAP Miner server kernel was called with an invalid option.

User Response: Contact IBM Software Support.

8212 **Command line option help requested.**

Explanation: The OLAP Miner server kernel was called to show the command line options.

User Response: No action is required.

8213 **This option is not supported <filename>.**

Explanation: The OLAP Miner server kernel was called with an invalid option.

User Response: Contact IBM Software Support.

8214 **Not enough file space available. Ensure that the temporary file directory contains enough space.**

Explanation: There is not enough temporary file space available.

User Response: Please increase the available file space or select less data to analyze.

8215 **Cannot open the log file<filename>. Check the access rights.**

Explanation: Cannot open the log file.

User Response: Ensure that you have access rights to the specified directory, or if the log file already exists, ensure that it is read-only. Change the read/write permissions accordingly.

8216 **Explanations for this model type are not supported.**

Explanation: An unsupported model option was specified.

User Response: Contact IBM Software Support.

8217 **Not enough memory available.**

Explanation: Not enough memory available.

User Response: Increase the amount of available memory or select less data to analyze.

8218 **The following parameter <filename> is missing.**

Explanation: A calling parameter is missing from an internal call.

User Response: Contact IBM Software Support.

8219 **These parameters <filename> are not valid.**

Explanation: One or more unknown parameters were specified internally.

User Response: Contact IBM Software Support.

8220 **Cannot read parameter file <filename>.**

Explanation: Cannot read the given parameter file.

User Response: Ensure that you have access rights to the specified directory. Change the read permissions accordingly.

8221 **Cannot read data file<filename>.**

Explanation: Cannot read the given data file.

User Response: Ensure that you have access rights to the specified directory. Change the read permissions accordingly.

8222 **No data file is specified.**

Explanation: No data file is specified.

User Response: Contact IBM Software Support.

8223 **The data file <filename> is empty.**

Explanation: The data file is empty.

User Response: Alter the definition to specify more data. If you cannot resolve the problem, contact IBM Software Support.

8224 **Invalid record length of parameter file. Check the record length.**

Explanation: The parameter file does not have a fixed record length.

User Response: Contact IBM Software Support.

8300 **Cannot initialize conversion for encoding <filename>.**

Explanation: The specified encoding is not supported by the OLAP Miner server kernel.

User Response: Contact IBM Software Support.

8301 **Cannot parse the XML definition file. The XML might be syntactically incorrect.**

Explanation: The OLAP Miner server kernel cannot parse the XML definition file.

User Response: Ensure that the definition file has not been modified manually. If it was modified, delete the definition, create a new definition, and run it again. If it was not modified, contact IBM Software Support.

8303 **Cannot find the <filename> tag in the XML definition file.**

Explanation: A required tag is missing from the XML definition file.

User Response: Ensure that the definition file has not been modified manually. If it was modified, delete the definition, create a new definition, and run it again. If it was not modified, contact IBM Software Support.

8304 **Cannot find required attribute <filename> of tag <filename> in the XML definition file.**

Explanation: The specified attribute of the specified tag is missing from the XML definition file.

User Response: Ensure that the definition file has not been modified manually. If it was modified, delete the definition, create a new definition, and run it again. If it was not modified, contact IBM Software Support.

8305 **Number of <filename> tags <filename> does not match the expected number <filename> specified in the XML definition file.**

Explanation: The number of the specified tags does not match the number that was provided in the enclosing tag.

User Response: Ensure that the definition file has not been modified manually. If it was modified, delete the definition, create a new

definition, and run it again. If it was not modified, contact IBM Software Support.

8306 Syntax error in the XML definition file.

Explanation: The syntax of the XML definition file is not correct.

User Response: Ensure that the definition file has not been modified manually. If it was modified, delete the definition, create a new definition, and run it again. If it was not modified, contact IBM Software Support.

8307 Value <filename> of attribute <filename> in tag <filename> is not allowed in the XML definition file.

Explanation: An incorrect value was specified for an attribute of a tag in the XML definition file.

User Response: Ensure that the definition file has not been modified manually. If it was modified, delete the definition, create a new definition, and run it again. If it was not modified, contact IBM Software Support.

8308 A dimension of type <filename> was specified in the XML definition file but could not be found in the database outline.

Explanation: The XML definition file does not contain a dimension of a required type. For example, there might be no Measure dimension specified in the XML file.

User Response: Ensure that the definition file has not been modified manually. If it was modified, delete the definition, create a new definition, and run it again. If it was not modified, contact IBM Software Support.

8309 More than one dimension of type <filename> was specified in the XML definition file.

Explanation: The XML definition file includes more than one dimension of a type in which only one dimension is allowed. You probably specified more than one Measure dimension.

User Response: Ensure that the definition file has not been modified manually. If it was modified, delete the definition, create a new definition, and run it again. If it was not modified, contact IBM Software Support.

8310 Incorrect value <filename> specified for the version attribute in the XML file. Only XML files for version <filename> are allowed.

Explanation: The version number specified in the XML definition file is not supported.

User Response: Ensure that the definition file has not been modified manually. If it was modified, delete the definition, create a new definition, and run it again. If it was not modified, contact IBM Software Support.

8311 Necessary arguments for <filename> were missing. Correct usage information was written to <filename>.

Explanation: Command line arguments for the kernel interface were insufficient.

User Response: Contact IBM Software Support.

8312 Value of attribute <filename> in tag <filename> in XML definition file is not an integer value.

Explanation: An integer value was not specified for an attribute in the XML definition file.

User Response: Ensure that the definition file has not been modified manually. If it was modified, delete the definition, create a new definition, and run it again. If it was not modified, contact IBM Software Support.

8313 Value of attribute <filename> in tag <filename> in XML definition file is not a double value.

Explanation: A double value was not specified for an attribute in the XML definition file.

User Response: Ensure that the definition file has not been modified manually. If it was modified, delete the definition, create a new definition, and run it again. If it was not modified, contact IBM Software Support.

8320 OLAP Error Message <filename>.

Explanation: The OLAP Miner kernel had an internal error communicating with the OLAP server.

User Response: Contact IBM Software Support.

8390 OLAP API error. Cannot fetch OLAP API handle.

Explanation: OLAP API error. Cannot fetch OLAP API handle.

User Response: Contact IBM Software Support.

8321 Cannot establish a connection to the OLAP server <filename> as user <filename>. OLAP server error message: <filename>.

Explanation: OLAP API error. Cannot fetch OLAP API handle.

User Response: Contact IBM Software Support.

8391 Cannot establish a connection to the OLAP server <filename> as user <filename>. OLAP server error message: <filename>.

Explanation: The OLAP Miner server kernel cannot establish a connection to the specified OLAP server.

User Response: Ensure that the OLAP server is running correctly and check your network connections.

8322 Cannot select database <filename> in application <filename> on the OLAP server <filename>. OLAP server error message: <filename>.

Explanation: The OLAP Miner server kernel could not select the specified database.

User Response: Ensure that the user from which you started the mining run has access to the database.

8392 Cannot select database<filename> in application <filename> on the OLAP server <filename>.

Explanation: The OLAP Miner server kernel could not select the specified database.

User Response: Ensure that the user from which you started the mining run has access to the database.

8323 Cannot open the outline of database <filename> in application <filename> on the OLAP server <filename>. OLAP server error message <filename>.

Explanation: The OLAP Miner server kernel could not open the outline for the specified database.

User Response: Ensure that the user from which you started the mining run has access to the database.

8393 Cannot open the outline of database <filename> in application <filename> on the OLAP server<filename>.

Explanation: The OLAP Miner server kernel could not open the outline for the specified database.

User Response: Ensure that the user from which you started the mining run has access to the database.

8325 **No data from database <filename> of application <filename> is available. OLAP server error message <filename>.**

Explanation: No data was returned by the OLAP server to the OLAP Miner server kernel.

User Response: Ensure that the database of the application that you want to mine is loaded with data for the members that you selected for analysis. You can check if data is loaded by issuing a report to the OLAP server or by viewing the database data in a spreadsheet application.

8395 **No data from database <filename> of application <filename> is available.**

Explanation: No data was returned by the OLAP server to the OLAP Miner server kernel.

User Response: Ensure that the database of the application that you want to mine is loaded with data for the members that you selected for analysis. You can check if data is loaded by issuing a report to the OLAP server or by viewing the database data in a spreadsheet application.

8327 **An error occurred while issuing a report. OLAP server error message <filename>.**

Explanation: The OLAP server API had an error while the OLAP Miner server kernel was issuing a report.

User Response: If an OLAP server error message is displayed, follow the instructions in the message. If you cannot resolve the problem, contact IBM Software Support.

8397 **An error occurred while issuing a report.**

Explanation: The OLAP server API had an error while the OLAP Miner server kernel was issuing a report.

User Response: If an OLAP server error

message is displayed, follow the instructions in the message. If you cannot resolve the problem, contact IBM Software Support.

8328 **Cannot write an OLAP report to file.**

Explanation: The OLAP server could not create a file while running the report that was used to extract the database values.

User Response: Ensure that your disk or partition is full. Create more disk space if necessary.

8329 **Error while fetching data from the OLAP server. OLAP server error message <filename>.**

Explanation: The OLAP server could not create a file while running the report that was used to extract the database values.

User Response: Ensure that your disk or partition is full. Create more disk space if necessary.

8399 **Error while fetching data from the OLAP server.**

Explanation: The OLAP server could not create a file while running the report that was used to extract the database values.

User Response: Ensure that your disk or partition is full. Create more disk space if necessary.

8330 **The OLAP Miner server kernel had an interface processing error.**

Explanation: The OLAP Miner server kernel had an internal interface error.

User Response: Contact IBM Software Support.

8331 **The file <filename> could not be created.**

Explanation: A file could not be created. This is possibly because an incorrect path was specified.

User Response: Ensure that your user ID has sufficient privileges to create the file, and that there is sufficient disk space.

8332 **The file <filename> could not be closed.**

Explanation: A file could not be closed.

User Response: Contact IBM Software Support.

8333 **An I/O error occurred for file <filename>.**

Explanation: An I/O error occurred for the specified file.

User Response: Check the status of the file and the system. It is possible that your disk or partition is full.

8334 **File <filename> could not be opened.**

Explanation: The specified file could not be opened.

User Response: Check the status of the file and the system. It is possible that your disk or partition is full.

8335 **Cannot write to cleanup file <filename>.**

Explanation: Cannot write to the cleanup file.

User Response: Ensure that your user ID has sufficient privileges to create the file, and that there is sufficient disk space.

8336 **Cannot open XML definition file <filename>.**

Explanation: Cannot open the XML definition file.

User Response: Check the status of the file and the system. It is possible that your disk or partition is full.

8337 **Cannot create results file <filename>.**

Explanation: The specified results file could not be created, possibly because an incorrect path for the results file was specified.

User Response: Ensure that your user ID has sufficient privileges to create the file and that there is sufficient disk space.

8340 **Error while reading outline.**

Explanation: An error occurred while compiling the cube outline information, which is required by the deviation detection algorithm.

User Response: Check the status of the file and the system.

8341 **Multiple instances of <filename> were found in a selection. Ensure that at most one member which is shared is included.**

Explanation: Multiple instances of a member were found. This is due to the XML definition file, which is created by the deviation detection wizard, containing more than one instance of a shared member.

User Response: Ensure that your selections do not contain multiple instances of shared members. Remember that non-additive members are automatically excluded.

8350 **Cannot read result file <filename> from kernel.**

Explanation: The OLAP Miner server kernel cannot read the results file specified.

User Response: Contact IBM Software Support.

8360 **Cannot create temporary directory <filename>.**

Explanation: A temporary directory for the temporary files, which is created during the run of the kernel of the OLAP Miner server, could not be created.

User Response: Check the temporary file space and ensure that your user ID has access to that space. If you cannot resolve this problem, contact IBM Software Support.

1051005 Incorrect password.

Explanation: The password that the user typed is incorrect.

User Response: Ensure that the password is spelled correctly and that the Caps Lock is not on. If you cannot resolve the problem, contact the system administrator.

1051012 The user ID does not exist.

Explanation: The DB2 OLAP server does not recognize the user ID.

User Response: Ensure that the user ID is spelled correctly. If you cannot resolve the problem, contact the system administrator.

1060044 The DB2 OLAP server API had an error trying to create temporary files. Ensure that your TMP and TEMP environment variables are set up correctly as documented in the DB2 OLAP Server documentation and release notes.

Explanation: There was an error in creating temporary files.

User Response: Ensure that your TMP and TEMP environment variables are set up correctly as documented in the DB2 OLAP Server documentation and release notes.

Notices

This information was developed for products and services offered in the U.S.A.

IBM may not offer the products, services, or features discussed in this document in other countries. Consult your local IBM representative for information on the products and services currently available in your area. Any reference to an IBM product, program, or service is not intended to state or imply that only that IBM product, program, or service may be used. Any functionally equivalent product, program, or service that does not infringe any IBM intellectual property right may be used instead. However, it is the user's responsibility to evaluate and verify the operation of any non-IBM product, program, or service.

IBM may have patents or pending patent applications covering subject matter described in this document. The furnishing of this document does not give you any license to these patents. You can send license inquiries, in writing, to:

IBM Director of Licensing
IBM Corporation
North Castle Drive
Armonk, NY 10504-1785
U.S.A.

For license inquiries regarding double-byte (DBCS) information, contact the IBM Intellectual Property Department in your country or send inquiries, in writing, to:

IBM World Trade Asia Corporation
Licensing
2-31 Roppongi 3-chome, Minato-ku
Tokyo 106, Japan

The following paragraph does not apply to the United Kingdom or any other country where such provisions are inconsistent with local law:
INTERNATIONAL BUSINESS MACHINES CORPORATION PROVIDES THIS PUBLICATION "AS IS" WITHOUT WARRANTY OF ANY KIND, EITHER EXPRESS OR IMPLIED, INCLUDING, BUT NOT LIMITED TO, THE IMPLIED WARRANTIES OF NON-INFRINGEMENT, MERCHANTABILITY OR FITNESS FOR A PARTICULAR PURPOSE. Some states do not allow disclaimer of express or implied warranties in certain transactions, therefore, this statement may not apply to you.

This information could include technical inaccuracies or typographical errors. Changes are periodically made to the information herein; these changes will be incorporated in new editions of the publication. IBM may make improvements and/or changes in the product(s) and/or the program(s) described in this publication at any time without notice.

IBM may use or distribute any of the information you supply in any way it believes appropriate without incurring any obligation to you.

Licenses of this program who wish to have information about it for the purpose of enabling: (i) the exchange of information between independently created programs and other programs (including this one) and (ii) the mutual use of the information which has been exchanged, should contact:

IBM Corporation
J74/G4
555 Bailey Avenue,
P.O. Box 49023
San Jose, CA 95161-9023
U.S.A

Such information may be available, subject to appropriate terms and conditions, including in some cases, payment of a fee.

The licensed program described in this information and all licensed material available for it are provided by IBM under terms of the IBM Customer Agreement, IBM International Program License Agreement, or any equivalent agreement between us.

Information concerning non-IBM products was obtained from the suppliers of those products, their published announcements or other publicly available sources. IBM has not tested those products and cannot confirm the accuracy of performance, compatibility or any other claims related to non-IBM products. Questions on the capabilities of non-IBM products should be addressed to the suppliers of those products.

This information contains examples of data and reports used in daily business operations. To illustrate them as completely as possible, the examples include the names of individuals, companies, brands, and products. All of these names are fictitious and any similarity to the names and addresses used by an actual business enterprise is entirely coincidental.

Any performance data contained herein was determined in a controlled environment. Therefore, the results obtained in other operating environments may vary significantly. Some measurements may have been made on development-level systems and there is no guarantee that these measurements will be the same on generally available systems. Furthermore, some

measurement may have been estimated through extrapolation. Actual results may vary. Users of this document should verify the applicable data for their specific environment.

Information concerning non-IBM products was obtained from the suppliers of those products, their published announcements or other publicly available sources. IBM has not tested those products and cannot confirm the accuracy of performance, compatibility or any other claims related to non-IBM products. Questions on the capabilities of non-IBM products should be addressed to the suppliers of those products.

If you are viewing this information softcopy, the photographs and color illustrations may not appear.

Trademarks

The following terms are trademarks of International Business Machines Corporation in the United States, other countries, or both:

DB2
DB2 OLAP Server
IBM
AIX

The following terms are trademarks or registered trademarks of other companies:

Lotus and 1-2-3 are trademarks of Lotus Development Corporation in the United States, other countries, or both.

Microsoft, Windows, Windows NT, and Windows 2000 are trademarks or registered trademarks of Microsoft Corporation.

Java or all Java-based trademarks and logos, and Solaris are trademarks of Sun Microsystems, Inc. in the United States, other countries, or both.

UNIX is a registered trademark in the United States, other countries or both and is licensed exclusively through X/Open Company Limited.

Other company, product, or service names may be trademarks or service marks of others.

Glossary

This glossary defines terms that are used in this book and throughout the IBM DB2 OLAP Server library.

alias name. An alternate name for a dimension or member.

block. A string of data elements that is recorded or transmitted as a unit.

cube. A multidimensional database. A multidimensional database is a method of referencing data through multiple dimensions. An individual cell is the intersection of a point for a set of dimensions.

data load. The process of populating a multidimensional database with data. Loading data establishes actual values for the values of the cells that are defined in the database outline for the database.

dense dimension. A dimension with a high probability for occupying one or more data points in every combination of dimensions that occurs.

descendant. Any member in a branch below a parent. A descendant could be a child, a grand child, a great-grand child, or lower.

deviation. A value that differs significantly from an expected value. OLAP Miner calculates the expected value of a selected cell by averaging values in all dimensions that intersect that cell.

deviation detection definition. A user-specified definition of a subset of data that contains at least one member that is selected as Member Only, usually from the Accounts dimension, to be mined for deviations. The rest of the deviation detection definition contains selections from all other dimensions in the cube as Member Only or Member and Descendants. The member that is

specified for deviation detection is mined in the context of all other members that are defined in the subcube.

dimension. A data category, such as time, accounts, products, or markets. In a multidimensional database outline, the dimensions represent the highest consolidation level.

generation. A layer in hierarchical tree structure that defines member relationships in a multidimensional database. DB2 OLAP Server orders generations incrementally from the member that is the name of the dimension (generation 1) to the leaf members.

generation name. A unique name that describes a generation in a database outline.

level. A branch within a dimension. The levels are numbered incrementally from the leaf member (level 0) to the root.

level name. A unique name that describes a level in a database outline.

linked reporting object. An object that can be attached to a cell in a cube such as a paragraph of text, a graph, bitmap image, audio clip, a uniform resource locator (URL), or a link to data in another DB2 OLAP Server database.

member. A discrete component within a dimension. For example, January 1997 or 1Qtr97 are typical members of a Time dimension.

Member and Descendants. A type of choice that is available when you select a member for a deviation detection definition. If you select a member as Member and Descendants, then the data that is associated with the member and the data that is associated with all descendants of the member is mined for deviations.

Member Only. A type of choice that is available when you select a member for a deviation

detection definition. If you select a member as Member Only, then only the data that is associated with that member is mined for deviations.

multidimensional data. The data in a multidimensional database. Data can include basic data values (loaded from an external source) that represent combinations of the lowest level of members in the dimensions of the database, data values that are calculated from the base data values, and rolled up data values that are created by combining values for members in dimension hierarchies.

named pipes. An API that is used for special node-to-node applications and particularly for access to communications and database servers.

OLAP application. An application that you create using the Application Manager or the ESSCMD commands (in IBM DB2 OLAP Server) or with the DB2 OLAP Integration Server desktop. An OLAP application can contain one or more multidimensional databases and any associated calculation scripts, report scripts, and data load rules.

online analytical processing (OLAP). A multidimensional, multi-user, client/server computing environment for users who need to analyze consolidated enterprise data in real time. OLAP systems feature zooming, data pivoting, complex calculations, trend analyses, and data modeling.

power user. A user that can access or build cubes and create deviation detection definitions that are associated with that cube. If users do not have this level of authority, they cannot create, edit, copy, rename, delete, or run a deviation detection definition. The authority level is defined in the server configuration file.

shared member. A member that explicitly shares storage space with another member of the same name. This member has an attribute that designates it as shared. Shared members prevent making extra calculations on a member that appears in more than one location in a database outline.

sibling. A child member at the same branch level.

Spreadsheet add-in. Software that merges with Microsoft Excel and Lotus 1-2-3 to enable analysis of multidimensional databases. The software library appears as a menu add-in to the spreadsheet and provides such features as connect, zoom-in, and calculate.

subcube. A user-defined subset of an OLAP cube (multidimensional database) that is mined for deviations. The deviation detection definition defines the user-defined subcube.

Index

A

- absolute difference 55
- associated standard deviation 55
- authorization 45

B

- back up and recovery 48

C

- calculation scripts 3
- client
 - configuration file 35
 - configuring 35
 - OMClient.cfg 35
 - starting 4
 - stopping 5
- client configuration file
 - language 35
 - missing_text 35
 - olap_miner_server 35
 - port 35
 - spreadsheet_path 35
 - sup_missing_rows 35
- client/server architecture 25
- close connection command 39
- command prompts, see OLAP Miner server commands 39
- configuration file
 - client 35
 - server 29
- creating
 - linked reporting objects 11

D

- data_dir element 29
- deleting
 - linked reporting objects 12
- deviation detection definitions
 - creating 13
 - Member and Descendants 51
 - Member Only 51
 - naming 14
 - requirements 3
 - restrictions 3
 - running 15
 - selecting members for 14
- Deviation Viewer 7
- deviations
 - analyzing 9

- deviations (*continued*)
 - examples 56
 - viewing 7
 - viewing in spreadsheet 8
 - viewing in the Deviation Viewer 8
- dimension hierarchies 3
- directory structure 27

E

- expected values 51
 - computing 54
 - description 54

G

- getting started 3

H

- help command 39

L

- label-only members 3
- language element 35
- linked reporting objects 11
 - creating 11
 - deleting 12
 - viewing in a spreadsheet 11
- list config command 39
- list connections command 39
- list runs command 39

M

- magnitude 55
- max_connections element 29
- max_kernel runs element 29
- mining run scheduler program 41
- mining runs
 - examples 43
 - scheduling 43
- missing_text element 35

N

- non-additive formulas 3

O

- OLAP Miner
 - description 51
 - getting started 3
 - overview 51
- OLAP Miner algorithm 51

- OLAP Miner client
 - configuration file 35
 - configuring 35
 - starting 4
 - stopping 5
- OLAP Miner server
 - configuration file 29
 - configuring 29
 - starting on AIX 33
 - starting on Windows 31, 33
 - stopping on AIX 34
 - stopping on Windows 34
- OLAP Miner server commands
 - close connection 39
 - help 39
 - list config 39
 - list connections 39
 - list runs 39
 - shutdown 39
 - sync olap 39
- OLAP Miner users v
- olap_miner_server element 35
- olap_server element 29
- OMClient.cfg
 - sample 35
- OMClientConfig element 35
- omrundef program 41, 43
- OMServer.cfg 29
- OMServerConfig file 29
- overview of tasks 3

P

- performance 45
- port element 29, 35
- power_user element 29, 45

R

- recovery 48
- requirements
 - label-only members 3
 - loaded and calculated cubes 3
 - non-additive cubes 3
- restriction
 - calculation scripts 3
 - dimension hierarchies 3
 - non-additive formulas 3
 - shared members 3
- retrieval buffer size requirement 45
- return codes 43

S

- sample
 - OMClient.cfg file 35
 - OMServer.cfg file 29
- scalability 45
- scheduling mining runs 43
- security 45
- selecting members 14
- server
 - configuration file 29
 - configuring 29
 - starting on AIX 33
 - starting on Windows 33
 - stopping on AIX 34
 - stopping on Windows 34
- server commands
 - close connection 39
 - help 39
 - list config 39
 - list connections 39
 - list runs 39
 - shutdown 39
 - sync olap 39
- server configuration file
 - data_dir 29
 - max_connections 29
 - max_kernel runs 29
 - olap_server 29
 - OMServerConfig 29
 - port 29
 - power_user 29
 - sample 29
 - serverlog 29
 - verbose 29
- server parameters, see server
 - configuration file 29
- serverlog element 29
- shared members 3
- shutdown command 39
- spreadsheet 7
 - viewing deviations 8
- spreadsheet_path element 35
- standardized residual 55
- starting 41
 - client 4
 - server 31
- stopping
 - client 4
 - server 34
- subcubes 51
 - creating 52
 - description 51, 52
- sup_missing_rows element 35
- sync olap command 39
- system architecture 25

T

- tutorial 13

V

- verbose element 29
- viewing
 - deviations 7
 - linked reporting objects 11

X

- XML
 - configuration files 58
 - working with 58
- XML client configuration file, see
 - client configuration file 35
- XML server configuration file, see
 - server configuration file 29

Contacting IBM

If you have a technical problem, please review and carry out the actions suggested by the product documentation before contacting DB2 OLAP Server Customer Support. This guide suggests information that you can gather to help DB2 OLAP Server Customer Support to serve you better.

For information or to order any of the DB2 OLAP Server products, contact an IBM representative at a local branch office or contact any authorized IBM software remarketer.

If you live in the U.S.A., you can call one of the following numbers:

- 1-800-237-5511 for customer support
- 1-888-426-4343 to learn about available service options

Product Information

If you live in the U.S.A., then you can call one of the following numbers:

- 1-800-IBM-CALL (1-800-426-2255) or 1-800-3IBM-OS2 (1-800-342-6672) to order products or get general information.
- 1-800-879-2755 to order publications.

<http://www.ibm.com/software/data/db2/db2olap/>

The DB2 OLAP Server World Wide Web pages provide current DB2 OLAP Server information about news, product descriptions, education schedules, and more.

<http://www.ibm.com/software/data/db2/db2olap/library.html>

The DB2 OLAP Server Technical Library provides access to frequently asked questions, fixes, books, and up-to-date DB2 technical information.

Note: This information may be in English only.

<http://www.elink.ibm.com/public/applications/publications/cgibin/pbi.cgi>

The International Publications ordering Web site provides information about how to order books.

<http://www.ibm.com/education/certify/>

The Professional Certification Program from the IBM Web site provides certification test information for a variety of IBM products.

Note: In some countries, IBM-authorized dealers should contact their dealer support structure instead of the IBM Support Center.