

---

# HP OmniBook Sojourn



---

## Troubleshooting Guide

## Notice

In a continuing effort to improve the quality of our products, technical and environmental information in this document is subject to change without notice.

This manual and any examples contained herein are provided “as is” and are subject to change without notice. Hewlett-Packard Company makes no warranty of any kind with regard to this manual, including, but not limited to, the implied warranties of merchantability and fitness for a particular purpose. Hewlett-Packard Co. shall not be liable for any errors or for incidental or consequential damages in connection with the furnishing, performance, or use of this manual or the examples herein.

Consumer transactions in Australia and the United Kingdom: The above disclaimers and limitations shall not apply to Consumer transactions in Australia and the United Kingdom and shall not affect the statutory rights of Consumers.

© Copyright Hewlett-Packard Company 1998. All rights reserved. Reproduction, adaptation, or translation of this manual is prohibited without prior written permission of Hewlett-Packard Company, except as allowed under the copyright laws.

The programs that control this product are copyrighted and all rights are reserved. Reproduction, adaptation, or translation of those programs without prior written permission of Hewlett-Packard Co. is also prohibited.

Portions of the programs that control this product may also be copyrighted by Microsoft Corporation, Phoenix Technologies, Ltd., NeoMagic, Inc., and American Megatrend, Inc. See the individual programs for additional copyright notices.

Microsoft, MS, MS-DOS, and Windows are registered trademarks of Microsoft Corporation. Pentium and the Intel Inside logo are U.S. registered trademarks and MMX is a U.S. trademark of Intel Corporation.

All certifications may not be completed at product introduction. Check with your HP reseller for certification status.

This equipment is subject to FCC rules. It will comply with the appropriate FCC rules before final delivery to the buyer.

Hewlett-Packard Company  
Mobile Computing Division  
19310 Pruneridge Ave.  
Cupertino, CA 95014, U.S.A.

## Edition History

Edition 1 ..... April 1998

---

# Contents

<b>Product Information</b> .....	<b>1-1</b>
Features and Operation .....	1-1
Power Modes .....	1-4
To select a power management profile .....	1-5
Checking the Status of the OmniBook .....	1-6
Using Function Keys .....	1-6
Resetting the OmniBook .....	1-7
System Resources .....	1-8
Specifications .....	1-10
<b>Battery Replacement</b> .....	<b>2-1</b>
Before you start removing the battery .....	2-1
To replace the battery .....	2-2
To optimize battery performance .....	2-6
Battery Safety .....	2-6
<b>Troubleshooting and Diagnostics</b> .....	<b>3-1</b>
Troubleshooting .....	3-3
Troubleshooting the Problem .....	3-4
Using Diagnostic Tools .....	3-12
Power-On Self-Test .....	3-13
OmniBook Diagnostic Program .....	3-16
BIOS Setup Utility .....	3-27
To change the keyboard layout .....	3-29
<b>Reference Information</b> .....	<b>4-1</b>
Password Removal Policy .....	4-1
Hewlett-Packard TFT Display Quality Statement .....	4-2
OmniBook Sojourn Replaceable Parts .....	4-4

## Figures

Figure 1-1. OmniBook - Front View .....	1-1
Figure 1-2. OmniBook - Back View .....	1-2
Figure 1-3. Multimedia Slice - Back View .....	1-2
Figure 1-4. OmniBook - Audio Features .....	1-2
Figure 3-1. Basic Troubleshooting Steps .....	3-3
Figure 3-2. OmniBook Diagnostic Screens — Basic and Advanced .....	3-16
Figure 3-3. Serial and Parallel Loopback Connectors .....	3-18

## Tables

Table 1-1. Summary of Features . . . . .	1-3
Table 1-2. Activating Power Modes . . . . .	1-4
Table 1-3. Power Mode Descriptions . . . . .	1-5
Table 1-4. Default Power Management Profiles . . . . .	1-5
Table 1-5. Status Light Indicators . . . . .	1-6
Table 1-6. Function Keys . . . . .	1-6
Table 1-7. System Interrupts . . . . .	1-8
Table 1-8. System Memory . . . . .	1-8
Table 1-9. System Input/Output Addresses (100-3FF) . . . . .	1-9
Table 1-10. DMA Channels . . . . .	1-9
Table 1-11. OmniBook Sojourn specifications . . . . .	1-10
Table 1-12. Multimedia slice specifications . . . . .	1-11
Table 1-13. Battery slice specifications . . . . .	1-11
Table 3-1. Troubleshooting Suggestions . . . . .	3-5
Table 3-2. Scope of Diagnostic Tools . . . . .	3-12
Table 3-3. POST Terminal-Error Beep Codes . . . . .	3-13
Table 3-4. POST Messages . . . . .	3-13
Table 3-5. OmniBook Diagnostic Error Codes . . . . .	3-19
Table 3-6. BIOS Setup Menus and Parameters . . . . .	3-27
Table 4-1. OmniBook Sojourn TFT XGA Display Quality Guidelines . . . . .	4-3
Table 4-2. OmniBook Sojourn Replaceable Parts List . . . . .	4-4

## Introduction

This troubleshooting manual provides reference information for the HP OmniBook Sojourn. It is intended to be used by HP-authorized service personnel in the installation, configuration, and troubleshooting of these products.

The manual is designed as a self-paced guide. It is intended to train you to install, configure, and troubleshoot OmniBook computers. You can follow this manual without having equipment available.

The following table lists additional places where you can get supplementary information about OmniBook products.

**Sources of OmniBook Information**

Source	Address or Number	Comments
HP External Web	<a href="http://www.hp.com/omnibook">http://www.hp.com/omnibook</a> ( <a href="http://www2.hp.com/omnibook">http://www2.hp.com/omnibook</a> , European mirror)	No usage restriction.
HP US Reseller Web	<a href="http://partner.americas.hp.com">http://partner.americas.hp.com</a>	Restricted to Authorized Resellers only.
HP Asia Pacific Channel Support Centre for DPSP Partners	<a href="http://www.hp.com.au">http://www.hp.com.au</a>	Restricted to DPSP Partners only.
America Online	Keyword: HP	Call (800) 827-6364 for membership within the US.
CompuServe*	GO HP	Call (800) 524-3388 for membership within the US.
HP Bulletin Board Service		Refer to the latest Product Support Plan for non-US BBS numbers.
HP First (automated fax)	(800) 333-1917	US and Canada.
	(801) 344-4809	Outside US and Canada.
	(800) 544-9976	Reseller support number (enter outlet id number).
HP Support Assist CD-ROM	(800) 457-1762	US and Canada.
	(801) 431-1587	Outside US and Canada.
* Baud rates = 300-28,800; Parity = E; Data bits = 7; Stop bits = 1.		



## Product Information

---

The HP OmniBook Sojourn is HP's thinnest, most sophisticated high-performance notebook PC for senior managers, executives, and key professionals. It is ultraportable (3.2 lb and .71 inch thick), and uses a 233-MHz mobile Pentium processor and 12.1-inch TFT display. This chapter describes:

- Features and operation (below).
- Specifications (page 1-10).

---

### Features and Operation

The following illustrations point out the main external features of the OmniBook Sojourn, multimedia slice.

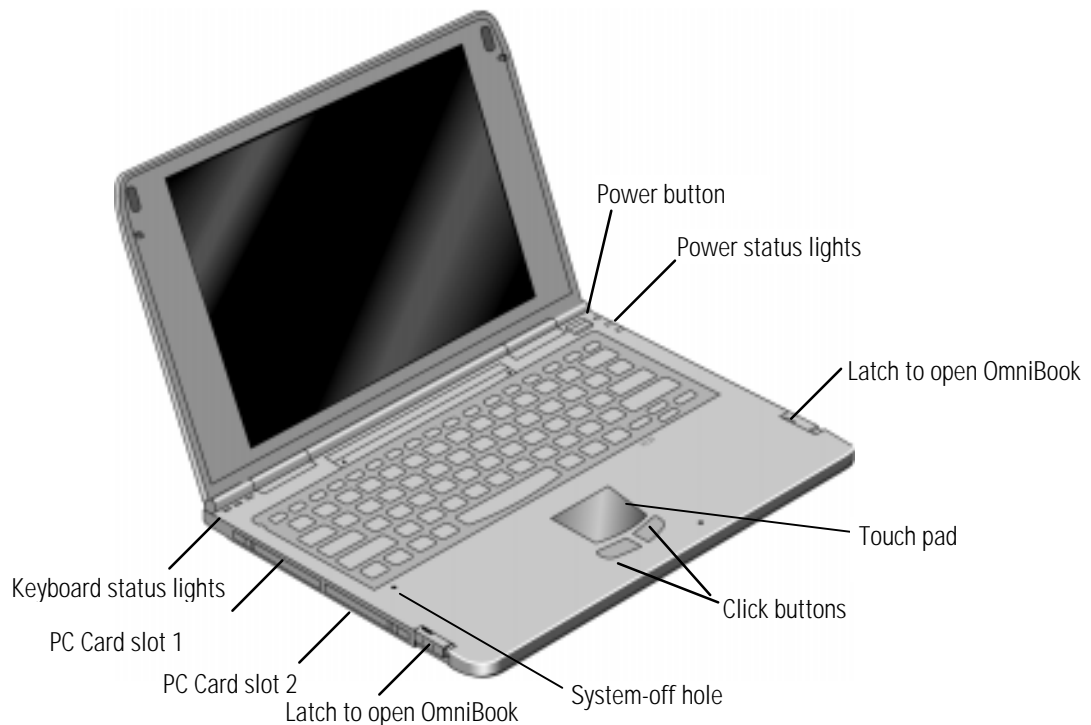

**Figure 1-1. OmniBook - Front View**

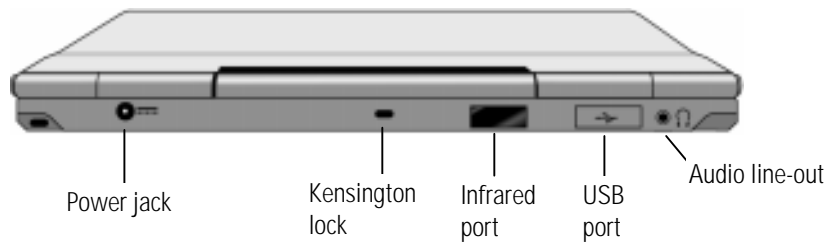

**Figure 1-2. OmniBook - Back View**

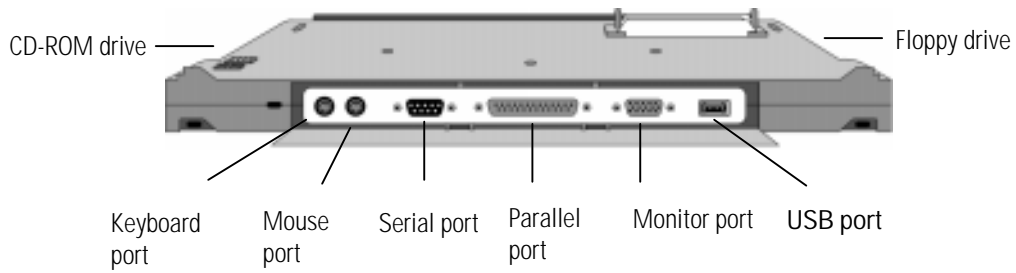

**Figure 1-3. Multimedia Slice - Back View**

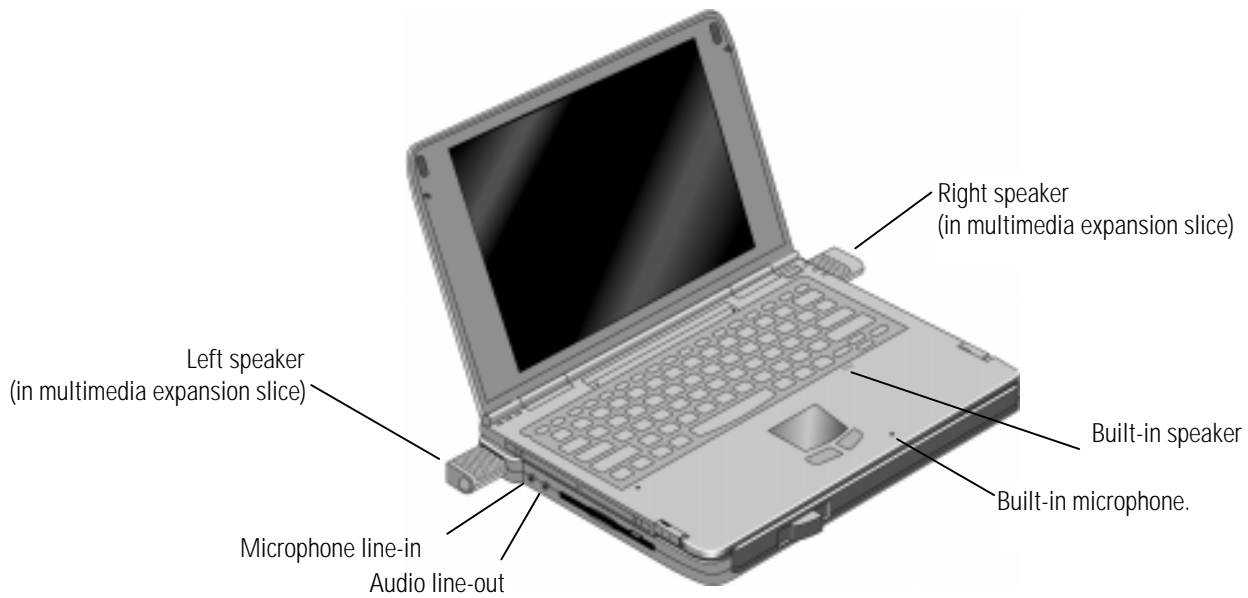

**Figure 1-4. OmniBook - Audio Features**



**Table 1-1. Summary of Features**

Processor and Bus Architecture	233-MHz Intel Pentium Processor with MMX technology. Intel's sub-2V low-power processor. 256-KB pipeline burst SRAM L2 cache. Intel 430MX Mobile Triton II chipset.
Memory	64-MB RAM, fixed; no extended memory slot.
Display	12.1-inch SVGA TFT (up to 800 x 600 x 64K colors).
Video	128-bit graphics controller with 9Mbit video RAM. Zoomed Video enabled.
PC Card	Two side-by-side Type II 16-/32-bit PC Card slots.
	CardBus enabled.
Operating System	Windows 95 pre-installed.
Power States	On, Standby, Suspend to Disk, Suspend to RAM, Off

## Power Modes

**Table 1-2. Activating Power Modes**

Power Mode	To Enter Mode	Comments
On	Press the Power button to turn the OmniBook on.	
Standby	Allow the time-out to expire without activity, but only if you have enabled the Standby time-out in Setup (normally disabled). –or– Click the Standby icon on the PowerPanel toolbar.	Press any key or move the mouse pointer to exit Standby mode.
Suspend to RAM	Press the power button while the OmniBook is on. <sup>1</sup> –or– From the Start menu, click Suspend. <sup>2</sup> –or– Click the “System Suspend” icon on the PowerPanel toolbar.	Press the power button to restore the session. The session resumes immediately
Save to Disk	Press the power button while the OmniBook is on. <sup>3</sup> –or– From the Start menu, click Suspend. <sup>4</sup> –or– Click the “System Save To Disk” icon on the PowerPanel toolbar.	Allow the time-out to expire without activity, but only if you have enabled the Standby time-out in Setup (normally disabled). –or– Press the Standby icon on the PowerPanel toolbar.
Off	From the Start menu, click Shut Down. Unsaved data will be lost. The OmniBook will reboot when you turn it back on. –or– Press the power button. <sup>5</sup>	Press the power button while the OmniBook is on. <sup>1</sup> –or– From the Start menu, click Suspend. <sup>2</sup> –or– Press the “System Suspend to RAM” icon on the PowerPanel toolbar.
<sup>1</sup> Requires following configuration: Switch Button set to “Suspend/Resume,” Suspend Mode set to “Suspend to RAM.” <sup>2</sup> Requires following configuration: Suspend Mode set to “Suspend to RAM.” <sup>3</sup> Requires following configuration: Switch Button set to “Suspend/Resume.” Suspend Mode set to “Save To Disk.” <sup>4</sup> Requires following configuration: Suspend Mode set to “Save To Disk.” <sup>5</sup> Requires following configuration: Switch Button set to “On/Off.” See the instructions on page 3-27 to configure the Switch (Power) button and Suspend mode.		

**Table 1-3. Power Mode Descriptions**

Power Mode	Description*	Required Setup Settings
Standby	Turns off the display only. Maintains network connections. Restarts quickly ("Instant On").	None
Suspend to RAM	Turns off the display. Saves current session in RAM. Saves significant power. Loses network connections. ** Restarts quickly ("Instant On").	Power menu Switch Button: Suspend/Resume Suspend Mode: Suspend to RAM
Save to Disk	Saves maximum power. Saves current session on hard disk. Loses network connections	Power menu Switch Button: Suspend/Resume Suspend Mode: Save-To-Disk
Off	Saves maximum power. Loses network connections. Resets everything at startup. Starts a new session at startup.	For using Start, Shut Down, none. For using the Power button, Power menu Switch Button: On/Off
<p>* If the ac adapter is connected, the OmniBook battery continues to charge in any mode. ** Windows 95 can restore the network connections when you turn on the OmniBook. For a different operating system, you may have to reboot the OmniBook or restart the operating system to restore them.</p>		

## To select a power management profile

PowerPanel provides a group of predefined profiles that you can select according to the type of work you are doing on the OmniBook. The following table describes the PowerPanel profiles.

For complete documentation about PowerPanel features, download the Phoenix *User's Guide* from: <http://www.phoenix.com/notebook/ppanel.html> or see the PowerPanel online Help (right-click on the PowerPanel toolbar, then click PowerPanel Help Topics).







**Table 1-4. Default Power Management Profiles**

Default Power Management Profiles
<b>AC.</b> Turns off video and hard disk drive after a predetermined period of time, but doesn't initiate automatic Suspend to RAM or Save to Disk modes.
<b>Maximum Performance.</b> Sets power saving features to give you the best system performance while still conserving power.
<b>Maximum Battery Life.</b> Sets power saving features to give you the maximum battery life and good performance.

## Checking the Status of the OmniBook

The OmniBook contains three status lights to the right of the keyboard and three status lights to the upper left of the keyboard. The lights to the right show power status, battery status and drive activity. The lights to the left show Caps lock, Num lock, and Scroll lock.

**Table 1-5. Status Light Indicators**

Indicator	Meaning
	<b>Power</b> Green when power is on. Orange when OmniBook is suspended (to RAM).
	<b>Battery power</b> Green when battery is completely charged. Orange when battery is charging.
	<b>Drive activity</b> The OmniBook is accessing the built-in hard disk drive.
	<b>Caps lock</b> Caps Lock is active.
	<b>Num lock</b> Num Lock is active.
	<b>Scroll lock</b> Scroll Lock is active.

## Using Function Keys

The keys labeled F1 through F12 on the top row of the keyboard provide shortcut key sequences for various system controls. The OmniBook keyboard shows the Fn hot keys labeled in orange.

The following table provides a list and description of the OmniBook Fn key combinations.

**Table 1-6. Function Keys**

Hot Keys	Effect
Fn + F8	Decreases the display's brightness.
Fn + F9	Increases the display's brightness.
Fn + F10	Toggles the speaker on and off (Mute key).
Fn + NL/SL	Toggles Scroll Lock on and off.
Fn + Up Arrow	Moves up one page.
Fn + Down Arrow	Moves down one page
Fn + Right Arrow	Moves to bottom of a file.
Fn + Left Arrow	Moves to top of a file.

## Resetting the OmniBook

1. Insert a straightened paper clip into the system off hole near the Fn key, as shown.
2. After the OmniBook shuts down, press the Power button to turn it on.

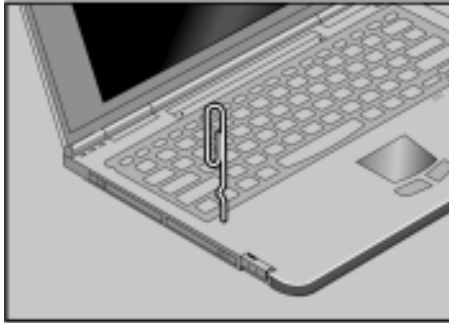

### Note

The OmniBook can boot from a CD under the following conditions:

- If you have the OmniBook docked to a multimedia slice\*, and
- If the boot order is defined in the Book Options section of the BIOS Setup with the CD-ROM drive before the hard drive,
- If you have a bootable CD in the drive, such as the OmniBook Recovery CD.

\*Boot from a CD-ROM is supported only from the built-in CD-ROM in the multimedia slice.

## System Resources

Below are default values for system resources. To see other, non-default possibilities, use the BIOS Setup utility (see “BIOS Setup Utility” on page 3-26).

The tables in this section show typical resource usage as set up by the OmniBook BIOS. Plug-and-play operating systems, drivers, and BIOS Setup settings may change some of the entries.

**Table 1-7. System Interrupts**

System Interrupts	OmniBook only	OmniBook with Multimedia Slice
0	System timer	System timer
1	Keyboard	Keyboard
2	Cascade to IRQ 9	Cascade to IRQ 9
3	COM2 serial port B port (Infrared) Free if Infrared disabled in BIOS.	COM2 serial port B port (Infrared)
4	COM1	COM1
5	ESS1879	ESS1879
6	Floppy drive controller	Floppy drive controller
7	LPT1	LPT1
8	Real-time clock	Real-time clock
9	PCI devices	CardBus controller
10	Free	Free
11	Free	Free
12	Touch pad	Touch pad
13	Numeric data processor	Numeric data processor
14	Internal hard disk (primary IDE controller)	Internal hard disk (primary IDE controller)
15	Internal CD-ROM drive (secondary IDE controller) - disabled if OmniBook is undocked.	Internal CD-ROM drive (secondary IDE controller)

**Table 1-8. System Memory**

System Memory Addresses	OmniBook only	OmniBook with Multimedia Slice
00000 - 9FFFF	System memory	System memory
A0000 - BFFFF	Video	Video
C0000 - CBFFF	Video BIOS	Video BIOS
CC000 - CCFFF	CardBus controller	CardBus controller
CD000 - DFFFF	Free (see below)	Free (see below)
E0000 - FFFFF	System BIOS	System BIOS

Valid uses for memory addresses CD000-DFFFF:

- Upper memory blocks (UMBs).
- PC Card memory windows.

**Table 1-9. System Input/Output Addresses (100-3FF)**

<b>Address</b>	<b>OmniBook only</b>	<b>OmniBook with Multimedia Slice</b>
0170-0177	Secondary IDE controller	Secondary IDE controller (CD-ROM)
01F0-01F7	Primary IDE controller	Internal hard disk
0220-022F	ESS1879 sound chip	ESS1879 sound chip
0376	Secondary IDE controller (disabled)	Secondary IDE controller (CD-ROM)
0378-037F	LPT1	LPT1 (printer port)
0330-0331 0338-038B	ESS1879 sound chip	ESS1879 sound chip
03B0-03BB	VGA adapter	VGA adapter
03C0-03DF	VGA adapter	VGA adapter
03F0-03F5	Floppy controller	Floppy controller
03F6	Primary IDE controller	Primary IDE controller
03F7	Floppy controller	Floppy controller
03F8-03FF	COM1	COM1
0900-0907	ES 1879 control interface	ES 1879 control interface
1000-101F	USB controller	USB controller

**Table 1-10. DMA Channels**

<b>DMA Channel</b>	<b>OmniBook only</b>	<b>OmniBook with Multimedia Slice</b>
0	Free	Free
1	ESS1879	ESS1879
2	Floppy drive	Floppy drive
3	ESS1879	ESS1879
4	DMA controller	DMA controller
5	Free	Free
6	Free	Free
7	Free	Free

# Specifications

This section describes hardware specification for the

- OmniBook Sojourn.
- OmniBook multimedia slice.
- OmniBook battery slice (double and quadruple).

**Table 1-11. OmniBook Sojourn specifications**

<b>Physical Attributes</b>	Size: 29.69 x 21.79 x 1.8 cm closed (11.69 x 8.58 x 0.71 inches). Weight: 1.45 kg (3.2 lb).
<b>Processor and Bus Architecture</b>	233-MHz Intel Pentium Processor* with MMX technology. Intel's sub-2V low-power processor. 256-KB pipeline burst SRAM L2 cache. Intel 430MX Mobile Triton II chipset.
<b>Graphics</b>	12.1-inch SVGA TFT (up to 800 x 600 x 64K colors). 128-bit graphics controller; 2-MB video RAM Zoomed Video enabled (back slot)
<b>Power</b>	Rechargeable lithium-ion battery; uses SMBus to manage power system. Battery recharges in 3 hrs while PC is off and 10 hrs while PC is on. Low-battery warning. Suspend/resume. Typical battery life with power management on: up to 1.5 hrs. Optional battery slices approximately quadruple typical battery life. ac adapter 100 to 240 Vac (50 to 60 Hz) input; 14 Vdc, 3.0 A output.
<b>Mass Storage</b>	2.1-GB non-removable hard drive. Included multimedia slice adds 3.5" 1.44-MB floppy drive (3-mode) and 24X (maximum) CD-ROM drive.
<b>RAM</b>	64-MB RAM, fixed; no extended memory slot.
<b>Audio System</b>	16-bit; Sound Blaster Pro-compatible. Integrated monaural speaker. Headphone-out mini-jack port. Included multimedia slice adds line-in, line-out, and two stereo speakers.
<b>Keyboard and Pointing Device</b>	82-key full-size QWERTY keyboard. Thin-hinge technology. Embedded numeric keypad. 12 function [Fn] keys. Touch pad.
<b>Input/Output and Expandability</b>	Universal serial bus (USB). Two side-by-side Type II 16-/32-bit PC Card slots; CardBus enabled. 4-Mbps IrDA-compliant infrared. Included multimedia slice adds 9-pin 115,200-bps serial port, 25-pin bidirectional ECP/EPP parallel port, video-out port, second USB port, PS/2 keyboard port, PS/2 mouse port, and audio ports. Multimedia slice video-out supports 800 x 600 x 64K colors at up to 85-Hz refresh rate or 1024 x 768 x 256 colors at up to 75-Hz refresh rate.



**Table 1-11 OmniBook Sojourn specifications (Continued)**

<b>Preinstalled Software</b>	Microsoft® Windows® 95 operating system. Advanced Power Management (APM 1.2). McAfee VirusScan Phoenix Power Panel.
<b>Environmental Limits</b>	Operating temperature: 5 to 35 °C (41 to 95 °F). Operating humidity: 20 to 90 percent RH (5 to 35 °C). Storage temperature: -20 to 50 °C (-4 to 122 °F).

**Table 1-12 Multimedia slice specifications**

<b>Model</b>	HP F1431A.
<b>Docking</b>	Warm dock (attaching or removing in Suspend).
<b>Floppy Disk Drive</b>	3 mode 3.5-inch (1.44MB/1.2MB/720KB).
<b>CD-ROM</b>	24x CD-ROM drive.
<b>Sound</b>	Built-in stereo speakers.
<b>Power Supply</b>	Supplied from the main unit.
<b>Security</b>	Kensington Microsaver lock slot.
<b>Weight</b>	Approximately 1.2 Kg.

**Table 1-13 Battery slice specifications**

<b>Model</b>	F1433A
<b>Capacity/Output Voltage</b>	5.220mAh/ 10.8V
<b>Battery Operation</b>	Approximately 5.4 hours (7.2 hours with the built-in battery)
<b>Time to charge</b>	Approximately 5 hours
<b>Weight</b>	Approximately 1.0Kg



## Battery Replacement

---

**NOTE**

The removal and installation of the internal battery should be performed by a qualified technician, such as your local IT or technical support technician. If you have questions that your local technical support cannot answer, contact your HP reseller. See the *Support and Service* booklet supplied with your OmniBook for additional contact information.

**Caution**

Battery may explode if incorrectly replaced. Replace only with the same type of battery supplied with your OmniBook (HP replacement part number F1432-69001). Dispose of used battery properly. Refer to the Battery Safety section of this document for disposal instructions.

---

### Before you start removing the battery

1. **Important:** Save your work.
2. From the Start menu, shut down the OmniBook.
3. Disconnect the ac adapter from the OmniBook.
4. Completely discharge the installed battery. To discharge the battery, unplug the ac adapter and leave the OmniBook on until it shuts itself off and you can no longer turn it back on.

---

## To replace the battery

### WARNING

Do not allow a metal object to touch the battery contacts. This could cause fire, burns, or electrical shock.

1. Open the OmniBook.



2. Carefully slide the keyboard cover plate toward the display (LCD) panel.

Note: The cover plate is hard to slide.



3. Lift the center of the back (side closest to the display) of the keyboard and gently bow the keyboard until the small catches on both sides of the keyboard are free.



4. Carefully fold the keyboard forward toward the front of the OmniBook and lay it on the OmniBook palm rest, taking care not to pull or stress the keyboard's flex cables.

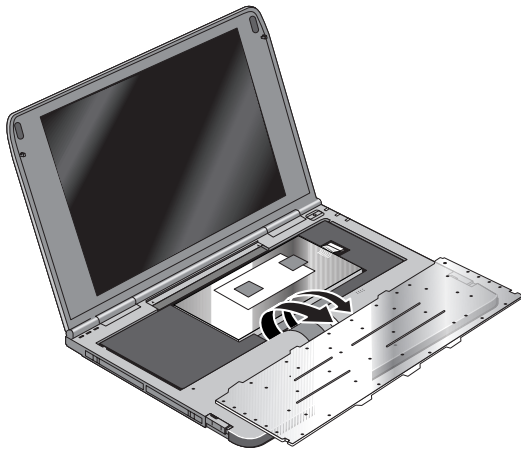

5. Pull out the battery cable from the connector.

**CAUTION:** Do not use any other metal objects to remove the cable from the connector.

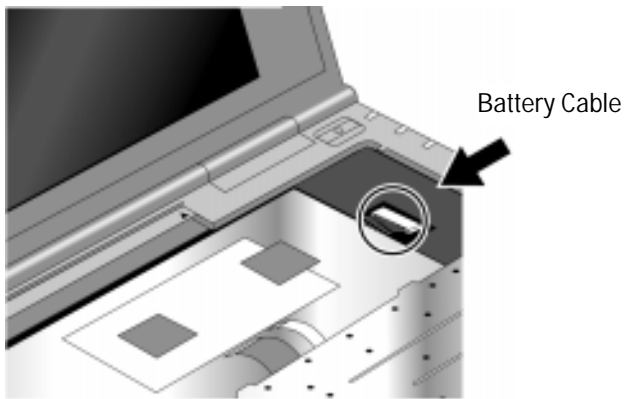

6. Remove the battery by sliding it toward the front of the OmniBook and lifting it out.



7. Insert the new battery into the OmniBook, making sure that the battery is seated flat against the bottom of the case.

8. Reconnect the battery cable.

9. Insert the four tabs on the front of the keyboard into the slots in the cover assembly.



10. Press the rear of the keyboard into place, making sure that the small catches on each side of the OmniBook are engaged.



11. Slide the keyboard cover plate forward toward the front of the OmniBook.  
You have completed installing the battery.

---

## To optimize battery performance

### CAUTION

Use only the HP F1434A adapter. Using another adapter could damage your OmniBook and void the warranty

- Fully charge and discharge a new battery 2 to 4 times:
  1. Connect the ac adapter and charge the battery to full capacity.
  2. Discharge the battery by unplugging the ac adapter and leaving the OmniBook turned on until the OmniBook shuts off.
- Do not leave batteries unused for long periods of time.
- Unplug your ac adapter when the OmniBook is not in use.

---

## Battery Safety

- To avoid risk of fire, burns, or damage to your battery, do not allow a metal object to touch the battery contacts, which could cause shorting.
- These batteries are suitable for use only with the HP OmniBook Sojourn. Check the *Support and Service* booklet for your local HP contact.
- Do not let a battery get moist or wet, which could cause shorting.
- Do not disassemble the battery. There are no serviceable parts inside.
- Handle a damaged or leaking battery with extreme care. If you come in contact with the electrolyte, wash the exposed area with soap and water. If it contacts the eye, flush the eye with water for 15 minutes and seek medical attention.
- When discarding a battery, contact your local waste disposal provider regarding local restrictions on the disposal or recycling of batteries. Cover the exposed battery terminals with electrician's tape before disposing of the battery. Do not dispose of a battery in fire or water.
- To obtain a replacement battery, contact your local dealer or HP sales office.
- Do not expose the battery to temperatures above 60 °C (140 °F) or below -20 °C (-4 °F).
- Do not use the battery in ambient temperatures above 35 °C (95 °F) or below 5 °C (41 °F). Do not use it in direct sunlight, near a heating source, or in relative humidity above 80% or below 20%.



## Troubleshooting and Diagnostics

---

This chapter includes diagnostic and troubleshooting information for testing the functionality of the OmniBook and identifying faulty modules. Note that the only replaceable module in the OmniBook unit is the internal battery. If the problem is caused by any other hardware failure, the faulty OmniBook will be exchanged for another unit.

**Note**

If the OmniBook Sojourn must be exchanged, it is the responsibility of the customer to back up any applications and data on the OmniBook's hard disk prior to exchange. The user should back up system data regularly. Refer to your lease and service agreements for information on service programs.

### Troubleshooting

“Troubleshooting the Problem” on page 3-4 provides a suggested overall approach to troubleshooting problems with the OmniBook and a table of possible solutions to problems. You should use this table to fix problems not related to hardware failures and to verify that problems are caused by hardware failures before exchanging the unit. The OmniBook hardware diagnostic program will detect almost all hardware problems. If you suspect a hardware problem, you should run this program.

### Diagnostic Tools

**Note**

Before arranging an exchange of the OmniBook Sojourn, try to verify that the problem is a hardware failure using the available diagnostic tools such as the OmniBook hardware diagnostic program or other diagnostic tools described in this section.

- **OmniBook hardware diagnostic program** (see “OmniBook Diagnostic Program” on page 3-16).
  - The OmniBook hardware diagnostic program provides two levels of testing:
    - User-level testing using the basic hardware test.
    - Advanced testing using the individual hardware tests.
  - The tests are designed to run after the system reboots. This ensures that the OmniBook will be in a predictable state, so the diagnostic program can properly test the hardware components. The tests are intended to preserve the state of the OmniBook. The OmniBook reboots when you exit the program so that you can return to your operating environment. .

- **Power-on self-test** (see “Power-On Self-Test” on page 3-13).
  - The Power-On Self-Test (POST) is a series of initialization routines and diagnostic tests that the system BIOS runs when the OmniBook boots. If the POST detects an error, the system will display an error message on the screen. The system BIOS will not boot the operating system if the system memory, CPU, DMA controller, or interrupt controller fails the POST diagnostic tests.
- **BIOS Setup Utility** (See “BIOS Setup Utility” on page 3-13)
  - The BIOS Setup utility provides access to basic configuration settings. It is independent of the operating system.

---

# Troubleshooting

The suggestions in this section can help isolate and repair the cause of a problem. To ensure quality repair, HP recommends that you follow the basic troubleshooting steps shown in the illustration below.

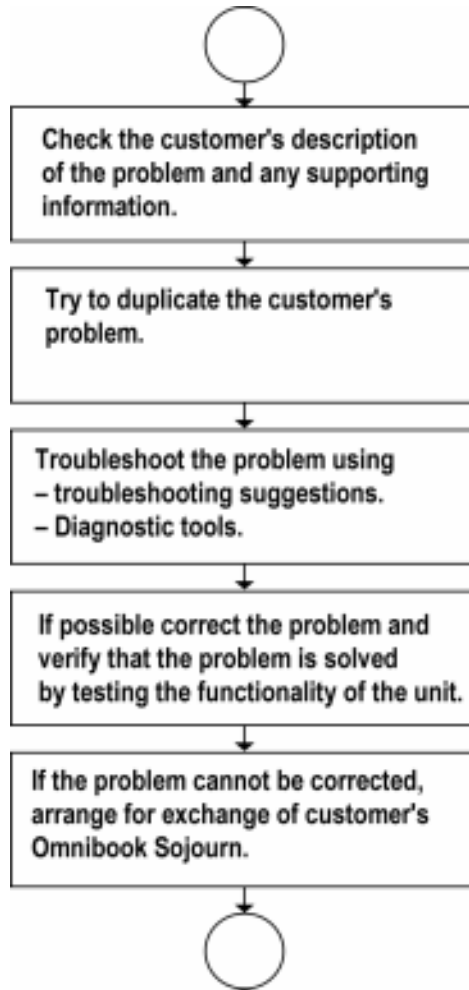

**Figure 3-1. Basic Troubleshooting Steps**

## Troubleshooting the Problem

### Record pertinent information about the unit:

- Model and serial number.
- Operating system and version.
- BIOS version.
- Accessories and peripherals used.

### Analyze the problem:

- **Observe Symptoms.** Using the customer's information, try to duplicate the problem. Determine how the problem differs from proper behavior. Also, take note of the functions that do work properly.
- **Separate Problems.** If there is more than one symptom, separate them into distinct problems.
- **Consider Causes.** Keep in mind possible causes for each problem, such as the ones listed in the tables below. Use the diagnostic tools to help find possible causes and repair the problem.  
“Table 3-1. Troubleshooting Suggestions” on page 3-5 lists general guidelines for actions to take with certain failure symptoms. The suggested order of investigation is not mandatory.

### Verify the cause of the problem

If possible, run the OmniBook diagnostic program. The OmniBook diagnostic program will detect most hardware problems.

#### Caution

The basic system test is non-destructive to data on your OmniBook. Some advanced tests may affect data your OmniBook. Make sure you have backed up your hard disk drive before running the advanced tests. Users should back up their data and applications regularly and prior to any testing.

Before arranging to exchange the OmniBook, verify that the problem is a hardware failure.

- Run the System Test in the OmniBook Diagnostic program.  
–and–
- Run the Test in the OmniBook Diagnostic program that checks the repaired function.  
–and–
- Run any other tests that failed during troubleshooting.

**Table 3-1. Troubleshooting Suggestions**

Symptom	Action	Comment
<b>Startup</b>		
The system's power fails to turn on.	Check whether the ac adapter is plugged in correctly. If the system is operating from the internal battery, check whether the battery is fully charged.	Connect the ac adapter plug correctly. The system's power cannot be turned on if the battery is fully exhausted or discharged. Connect the ac adapter to the unit to supply power to the system and recharge the battery.
System does not boot.	Try rebooting from floppy drive. You need to connect the OmniBook with the multimedia slice to do this.	If the OmniBook boots from floppy drive, check boot disk setting in BIOS. See "BIOS Setup Utility" on page 3-26. Reload hard drive from recovery CD-ROM. Contact Hewlett-Packard.
Does not boot on ac or battery, no display.	Check the power source. Check the ac adapter. Push system-off button. Try rebooting from floppy drive.	If the OmniBook boots from floppy drive, reprogram BIOS. See "BIOS Setup Utility" on page 3-26. Run OmniBook hardware diagnostic program. See "OmniBook Diagnostic Program" on page 3-16. Reload hard drive
Does not boot on battery (boots on ac)	Check battery level on status panel and battery LEDs. Recharge the battery properly according to "To recharge the internal battery" in the user's guide.	Make sure the room temperature is within the operating temperature specification for the OmniBook and charge the battery for at least 10 hours. If battery will not recharge, battery may need replacing.
Does not boot from floppy drive	Check boot order in BIOS Setup. Make sure the OmniBook is docked properly.	
Error message such as "Invalid system disk" or "Auto IDE error."	Run OmniBook hardware diagnostic program.	See "OmniBook Diagnostic Program" on page 3-16.
Sluggish startup or shutdown.	Run ScanDisk and Disk Defragmenter to check and optimize the hard drive. Delete temporary and unneeded files.	
Password has been forgotten	Contact HP.	

Symptom	Action	Comment
<b>Battery</b>		
The battery cannot be charged.	Recharge the battery properly according to "To recharge the internal battery" in the user's guide. Check the power source. Check ac adapter. If available, try another ac adapter.	If battery will not recharge, battery may need replacing.
Short battery operating time.	Turn down display brightness. Check power management settings in BIOS Setup. Try the default settings. Inform user that certain applications can cause excess power usage. (User can get power monitor from <a href="http://www.intel.com">www.intel.com</a> and monitor CPU load.) Remove LAN and PC cards and modems when not in use. Recharge the battery properly according to "To recharge the internal battery" in the user's guide.	LAN and PC cards and modems may have very high usage and idle power consumption. Make sure the room temperature is within the operating temperature specification for the OmniBook and charge the battery for at least 10 hours. If the battery has an extremely short operating time, it may need replacing.
Battery slice does not work, main battery works.	Check that battery slice is properly seated.	
Battery slice cannot be charged.	Check whether the battery slice was recharged correctly.	Recharge the battery slice properly according to "To charge a battery slice" in the user's guide.
The battery operating time is extremely short	Replace the battery.	If the recharged battery does not work or has short operating time, it may need to be replaced.

Symptom	Action	Comment
<b>Display</b>		
Nothing appears on the display screen.	Press the keys or power button to check whether the OmniBook has been switched to the Power Savings mode. Press system-off switch. Check whether the contrast control is in best position.	Restore the OmniBook from the Power Savings mode.  Adjust the contrast control the obtain best contrast.
Bright or missing pixels or lines	See "Hewlett-Packard TFT Display Quality Statement" on page 4-2.	

Symptom	Action	Comment
<b>Hard Disk</b>		
The OmniBook does not start from the hard disk.	<p>Check whether the setup utility has the proper configuration set for the hard disk.</p> <p>Check whether the security is set using the Setup utility.</p> <p>Check whether the operating system file is damaged or has a problem.</p>	<p>Set the hard disk on the Primary Master screen properly. See "BIOS Setup Utility" on page 3-26.</p> <p>Set Fixed Disk Boot Sector. See "BIOS Setup Utility" on page 3-26.</p> <p>Insert the floppy disk containing operating system in the floppy disk drive and try to start up the system from the floppy disk.</p>
Hard disk never spins.	<p>Check the power source.</p> <p>Reset the OmniBook and restart.</p>	If the power source is OK, the hard disk may be defective.
Hard disk makes clunking or scratching noise.	Back up the drive immediately.	Was the OmniBook or drive dropped?
Hard disk makes buzzing or whining noise.	<p>Back up the drive immediately.</p> <p>Check for alternate noise sources.</p>	If a keystroke causes the sound to change, it may be power supply noise.
Files are corrupted.	Run a virus scan program. Boot to DOS and run SCANDISK to look for problems, run SCANDISK /f to fix. Run Scandisk surface scan to check the platter. Use Recovery CD to recover the factory build.	

Symptom	Action	Comment
<b>Floppy Disk</b>		
Floppy disk drive fails to work.	<p>Check whether the OmniBook is connected properly to the multimedia slice.</p> <p>Check whether the floppy disk is properly loaded in the floppy disk drive.</p> <p>Try using another floppy disk.</p>	<p>See "To connect the expansion slice" in the user's guide.</p> <p>Unload the Floppy Disk from the Floppy Disk Drive and reload it correctly.</p>

Symptom	Action	Comment
<b>Keyboard</b>		
The keyboard fails to respond.	Check whether the OmniBook has been switched to the suspend mode.	Restore the OmniBook from the suspend mode.
Keys do not type the characters marked on the keys.	Make sure the correct keyboard layout is selected.	See "To change the keyboard layout" on page 3-29.

Symptom	Action	Comment
<b>External Keyboard, Numeric Keypad or Mouse</b>		
The external keyboard, numeric keypad or mouse fails to respond.	<p>Check whether the cable of the input device is connected securely to the OmniBook.</p> <p>Make sure the OmniBook is docked correctly with the multimedia slice.</p>	<p>Connect the cable securely.</p> <p>Shut down the OmniBook and reconnect the multimedia slice</p>

Symptom	Action	Comment
<b>Printer</b>		
Parallel printer does not work.	<p>Check whether the OmniBook is connected properly to the multimedia slice.</p> <p>Check whether the printer's cable is connected securely to the OmniBook.</p> <p>Check whether Setup utility has enabled the parallel port.</p> <p>Check whether the printer driver used is correct.</p> <p>Check whether the printer has been turned on before turning on the OmniBook.</p>	<p>See "To connect the expansion slice" in the user's guide.</p> <p>Connect the printer correctly according to "To connect a parallel device" in the user's guide.</p> <p>.Set the correct value of parallel port. See "BIOS Setup Utility" on page 3-26.</p> <p>Use a printer driver that supports the printer connected. See "Installing Drivers" in the user's guide.</p>

Symptom	Action	Comment
<b>Touch Pad</b>		
The touch pad fails to work or does not work properly.	<p>Check whether the driver for the touch pad is used.</p> <p>Check the setting of the driver for the touch pad.</p>	<p>Use the driver for the touch pad. See "Installing Drivers" in the user's guide.</p> <p>Sets the driver for the touch pad for easy use.</p>

Symptom	Action	Comment
<b>Infrared Communication</b>		
Infrared communication is impossible.	Check whether the Setup utility has enabled the serial B port.	Set the correct value for base I/O address of the Serial B port so that it is not fall on the address or IRQs of another items.
	Check whether the surface of the infrared communication port is dirty.	Clean the surface of the port.
	Check whether a cable or any other obstacle is placed between the two infrared ports.	Do not place anything between the two ports.
	Disable and then re-enable IR using the Options tab of the IR monitor.	The OmniBook may have been suspended and resumed with IR enabled.
	Uninstall the IR using the uninstall procedure and reinstall it carefully following the procedure	IR may not have been installed correctly
	Run the 2-unit IR test in the OmniBook diagnostic program.	See page 3-16.



Symptom	Action	Comment
<b>Infrared Communication (Continued)</b>		
Data is transferred incorrectly, or something is received in a non-communication mode.	<p>Check whether there is any bright light source, such as sunshine or incandescent light, near the system.</p> <p>Check whether there is any device using infrared, such as a remote control or wireless headphones, near the OmniBook system.</p> <p>Check whether the distance between the ports is correct and the angle between the ports is OK.</p> <p>Check whether the communication protocol matches the one for the remote system.</p>	<p>Use your system at locations away from sunshine or any other bright light source.</p> <p>During infrared communication, avoid using any other infrared devices near the system.</p> <p>Use the correct distance and angle of range according to "To make an infrared connection in the user's guide.</p> <p>Match the communication protocol according to the help screen of the utility.</p>

Symptom	Action	Comment
<b>CD-ROM</b>		
CD-ROM fails to work.	<p>Check whether the OmniBook is connected properly to the multimedia slice.</p> <p>Check whether the CD-ROM is properly loaded in the CD-ROM drive.</p> <p>Try using a different CD-ROM.</p>	<p>See "To connect the expansion slice" in the user's guide.</p> <p>Unload the CD-ROM from the CD-ROM drive and reload it correctly.</p> <p>The CD-ROM may be defective.</p>

Symptom	Action	Comment
<b>Microphone, Headphones, Other audio equipment</b>		
Audio function does not work.	Check whether the OmniBook is connected properly to the multimedia slice.	See "To connect the expansion slice" in the user's guide.
Recording cannot be done.	<p>Check whether the microphone plug is correctly connected to the line/microphone input jack on the OmniBook.</p> <p>Check whether the microphone's power is on.</p> <p>Check whether the audio equipment plug is correctly connected to the line/microphone input jack on the OmniBook.</p>	<p>Connect the plug correctly. See "To connect audio devices" in the user's guide.</p> <p>Turn on the microphone's power.</p> <p>Connect the plug correctly. See "To connect audio devices" in the user's guide.</p>
No sound output	<p>Check whether the headphone is correctly plugged into the audio output jack.</p> <p>Check whether the speaker with a built-in amplifier is correctly plugged into the audio output jack on the OmniBook.</p> <p>Check whether the power of the speaker with a built-in amplifier is on.</p>	<p>Connect the plug correctly. See "To connect audio devices" in the user's guide.</p> <p>Connect the plug correctly. See "To connect audio devices" in the user's guide.</p> <p>Turn on the power of the amplified built-in speaker.</p>

Symptom	Action	Comment
<b>Serial Port</b>		
The Serial port fails to work.	<p>Check whether the cable of Serial port is connected securely to the OmniBook.</p> <p>Check whether OmniBook is docked correctly with multimedia slice.</p> <p>Check whether Setup utility has enabled the serial port.</p> <p>Check whether the software used is set correctly for using Serial port.</p>	<p>Connect the cable securely. See "To connect a serial device" in the user's guide.</p> <p>See "To connect the expansion slice" in the user's guide.</p> <p>Set the correct value of the Serial port. See "BIOS Setup Utility" on page 3-26.</p> <p>Use the correct software. See "Installing drivers" in the user's guide.</p>

Symptom	Action	Comment
<b>PC Card</b>		
The PC Card fails to work properly.	<p>Check whether the PC Card is installed correctly in the OmniBook.</p> <p>Check whether the cable is connected correctly to the PC Card. (Only for the communication PC card)</p> <p>Check whether the software used is correct for using the PC card</p> <p>Check whether the OmniBook switches to the suspend mode before a PC card failure occurs (When using a communication PC card).</p> <p>Check whether the PC card has been installed or removed during OmniBook operation.</p>	<p>Install the PC Card properly. See "To insert a PC Card" in the user's guide and the documentation included with the PC card.</p> <p>Connect the cable correctly. See the documentation included with the PC card.</p> <p>Install the software correctly according to the "Installing Software" chapter in the user's guide and the documentation included with the PC card.</p> <p>Restart the OmniBook. (Set the OmniBook so that it does not switch to the Suspend mode while using the communication PC card.)</p> <p>Install or remove the PC card correctly according to "To remove a PC Card" in the user's guide.</p>
PC card is hot		This is normal for many cards.

Symptom	Action	Comment
<b>External Monitor</b>		
The external monitor does not display anything.	<p>Check whether the external monitor is turned on.</p> <p>Check whether the brightness and contrast of the external monitor are adjusted correctly.</p> <p>Check whether the cable of the external monitor is connected securely to the connector on the multimedia slice.</p> <p>Check whether the OmniBook is in Suspend to RAM mode.</p> <p>Check whether the OmniBook is connected properly to the multimedia slice.</p>	<p>Turn on the external monitor.</p> <p>Adjust the brightness and contrast of the external monitor according to the manual supplied with external monitor.</p> <p>Connect the cable securely. See "To connect an external monitor" in the user's guide.</p> <p>Press any key or power switch to restore the OmniBook from Suspend mode.</p> <p>See "To connecting the expansion slice" in the user's guide.</p>
Simultaneous display of the external monitor and the LCD display is impossible.	Check whether the external monitor supports the resolution used for the LCD display.	Use an external monitor that supports the resolution used for the LCD.
High resolution display is impossible.	<p>High resolution display is possible only under the Windows 95 environment.</p> <p>Check whether the driver for high resolution display is installed correctly.</p>	Install the driver correctly. . See "installing Drivers" in the user's guide.
The display position is skewed or the screen is distorted.	Adjust the display dimensions, position, or pincushion distortion according to the manual supplied with the external monitor.	This is not a failure.

# Using Diagnostic Tools

This section describes the following diagnostic tools you can use for troubleshooting and repairing the OmniBook:

- Power-on self-test (POST).
- OmniBook hardware diagnostic program.
- BIOS Setup utility.

The following table shows how you can use the different diagnostic tools to isolate the cause.

**Table 3-2. Scope of Diagnostic Tools**

Function	OmniBook Diagnostics	Power-On Self-Test	BIOS Setup
<b>Bootup</b>		Tests	Configures
<b>Processor</b>	Tests (System menu)	Tests	
<b>Memory</b>	Tests (Memory menu)	Tests	Describes
<b>Display</b>	Tests (Memory, Video menus)		
<b>Hard disk</b>	Tests (IDE menu)	Tests	Configures
<b>Floppy drive</b>	Tests (FDD menu)	Tests	Describes
<b>Keyboard</b>	Tests (KBD menu)	Tests	
<b>Touch pad</b>	Tests (Misc menu)		Configures
<b>Audio and Speakers</b>	Tests (System, Misc menu)		Configures
<b>Serial</b>	Tests* (Misc menu)		Configures
<b>Parallel</b>	Tests* (Misc menu)		Configures
<b>Infrared</b>	Tests† (Misc Menu)		Configures
<b>PS/2 port</b>	Tests† (KBD, Misc menus)		
<b>USB</b>	Tests† (System menus)		
<b>PCMCIA</b>			
<b>CD-ROM drive</b>	Tests (IDE menu)	Tests (with boot CD)	Configures
* The diagnostic test is more thorough if you use a loopback connector. See page 3-18. † Connect an appropriate external device to exercise the port. See the help text for the tests in the menu			

## Power-On Self-Test

The POST (Power-On Self-Test) is a series of initialization routines and diagnostic tests that the system BIOS runs when the OmniBook boots. The system BIOS will not boot the operating system if system memory, the CPU, DMA, or the interrupt controller fails the POST diagnostic tests. POST progress is indicated by a sequence of codes. If possible, error messages are displayed.

You should not interpret the failure of one or more POST tests as a hardware, software, or firmware failure. First, confirm the failure with a “clean” boot:

- Remove all accessories, including RAM boards, floppy drive, port replicator, PC Cards, printer, external monitor, pointing device, and keyboard.
- Provide “clean” ac power—no auto adapter or unusual ac adapter configuration.
- Press the system-off button to start from a known state.

If the OmniBook fails to boot with a clean boot, it requires repair. If an error message is displayed, *confirm the problem using other diagnostic tools*. Not all POST messages indicate a hardware, software, or firmware failure—some messages are informational messages.

If the BIOS detects a terminal error condition, it halts POST after issuing a terminal error beep code—up to four groups of 1 to 4 short beeps. The beep code indicates the POST routine in which the terminal error occurred. The BIOS also issues a beep code (one long tone followed by two short tones) during POST if the video configuration fails (no card installed or faulty) or if an external ROM module does not properly checksum to zero.

**Table 3-1. POST Terminal-Error Beep Codes**

Beep Codes	POST Description
1	One short beep before boot
1-2	Search for option ROMs. One long, two short beeps on checksum failure
1-2-2-3	BIOS ROM checksum
1-3-1-1	Test DRAM refresh
1-3-1-3	Test 8742 Keyboard Controller
1-3-4-1	RAM failure on address line xxxx
1-3-4-3	RAM failure on data bits xxxx of low byte of memory bus
1-4-1-1	RAM failure on data bits xxxx of high byte of memory bus
2-1-2-3	Check ROM copyright notice
2-2-3-1	Test for unexpected interrupts

The following table lists POST messages and explanations for reported problems. If the system fails after you make changes in BIOS Setup, reset the OmniBook, enter BIOS Setup, and install the defaults or correct the error.

**Table 3-2. POST Messages**

Message	Description
0200 Failure Fixed Disk	Fixed disk is not working or not configured properly. Check to see if fixed disk is attached properly. Run Setup. Find out if the fixed-disk type is correctly identified.
0210 Stuck key	Stuck key on keyboard.
0211 Keyboard error	Keyboard not working.

Message	Description
0212 Keyboard Controller Failed	Keyboard controller failed test. May require replacing keyboard controller.
0213 Keyboard locked - Unlock key switch	Unlock the system to proceed.
0220 Monitor type does not match CMOS - Run SETUP	Monitor type not correctly identified in Setup
0230 Shadow Ram Failed at offset: <i>nnnn</i>	Shadow RAM failed at offset <i>nnnn</i> of the 64k block at which the error was detected.
0231 System RAM Failed at offset: <i>nnnn</i>	System RAM failed at offset <i>nnnn</i> of in the 64k block at which the error was detected.
0232 Extended RAM Failed at offset: <i>nnnn</i>	Extended memory not working or not configured properly at offset <i>nnnn</i> .
0250 System battery is dead - Replace and run SETUP	The CMOS clock battery indicator shows the battery is dead. Connect the ac adapter for at least 24 hours, replace the motherboard.
0251 System CMOS checksum bad - Default configuration used	System CMOS has been corrupted or modified incorrectly, perhaps by an application program that changes data stored in CMOS. The BIOS installed Default Setup Values. If you do not want these values, enter Setup and enter your own values. If the error persists, check the system battery. Connect the ac adapter for at least 24 hours, replace the motherboard.
0260 System timer error	The timer test failed. Requires repair of system board.
0270 Real time clock error	Real-time clock fails BIOS test. May require board repair.
0280 Previous boot incomplete - Default configuration used	Previous POST did not complete successfully. POST loads default values and offers to run Setup. If the failure was caused by incorrect values and they are not corrected, the next boot will likely fail. This error is cleared the next time the system is booted.
0281 Memory Size found by POST differed from CMOS	Memory size found by POST differed from CMOS.
02B0 Diskette drive A error 02B1 Diskette drive B error	Drive A: or B: is present but fails the BIOS POST diskette tests. Check to see that the drive is defined with the proper diskette type in Setup and that the diskette drive is attached correctly.
02B2 Incorrect Drive A type - run SETUP	Type of floppy drive A: not correctly identified in Setup.
02B3 Incorrect Drive B type - run SETUP	Type of floppy drive B: not correctly identified in Setup.
02D0 System cache error - Cache disabled	RAM cache failed and BIOS disabled the cache. On older boards, check the cache jumpers. You may have to replace the cache. See your dealer. A disabled cache slows system performance considerably.
02F0: CPU ID:	CPU socket number for Multi-Processor error.
02F4: EISA CMOS not writeable	ServerBIOS2 test error: Cannot write to EISA CMOS.
02F5: DMA Test Failed	ServerBIOS2 test error: Cannot write to extended DMA (Direct Memory Access) registers.
02F6: Software NMI Failed	ServerBIOS2 test error: Cannot generate software NMI (Non-Maskable Interrupt).
02F7: Fail-Safe Timer NMI Failed	ServerBIOS2 test error: Fail-Safe Timer takes too long.
<i>device</i> Address Conflict	Address conflict for specified device.
Allocation Error for: <i>device</i>	Run ISA or EISA Configuration Utility to resolve resource conflict for the specified device.
CD ROM Drive	CD ROM Drive identified.
Entering SETUP ...	Starting Setup program

Message	Description
<b>Failing Bits: <i>nnnn</i></b>	The hex number <i>nnnn</i> is a map of the bits at the RAM address which failed the memory test. Each 1 (one) in the map indicates a failed bit. See errors 230, 231, or 232 above for offset address of the failure in System, Extended, or Shadow memory.
<b>Fixed Disk <i>n</i></b>	Fixed disk <i>n</i> (0-3) identified.
<b>Invalid System Configuration Data</b>	Problem with NVRAM (CMOS) data.
<b>I/O device IRQ conflict</b>	I/O device IRQ conflict error.
<b>PS/2 Mouse Boot Summary Screen:</b>	PS/2 Mouse installed.
<b><i>nnnn</i> kB Extended RAM Passed</b>	Where <i>nnnn</i> is the amount of RAM in kilobytes successfully tested.
<b><i>nnnn</i> Cache SRAM Passed</b>	Where <i>nnnn</i> is the amount of system cache in kilobytes successfully tested.
<b><i>nnnn</i> kB Shadow RAM Passed</b>	Where <i>nnnn</i> is the amount of shadow RAM in kilobytes successfully tested.
<b><i>nnnn</i> kB System RAM Passed</b>	Where <i>nnnn</i> is the amount of system RAM in kilobytes successfully tested.
<b>Operating system not found</b>	Operating system cannot be located on either drive A: or drive C:. Enter Setup and see if fixed disk and drive A: are properly identified.
<b>Parity Check 1 <i>nnnn</i></b>	Parity error found in the system bus. BIOS attempts to locate the address and display it on the screen. If it cannot locate the address, it displays ????. Parity is a method for checking errors in binary data. A parity error indicates that some data has been corrupted.
<b>Parity Check 2 <i>nnnn</i></b>	Parity error found in the I/O bus. BIOS attempts to locate the address and display it on the screen. If it cannot locate the address, it displays ????.
<b>Press &lt;F1&gt; to resume, &lt;F2&gt; to Setup, &lt;F3&gt; for previous</b>	Displayed after any recoverable error message. Press <F1> to start the boot process or <F2> to enter Setup and change the settings. Press <F3> to display the previous screen (usually an initialization error of an Option ROM, such as an add-on card). Write down and follow the information shown on the screen.
<b>Press &lt;F2&gt; to enter Setup</b>	Optional message displayed during POST.
<b>PS/2 Mouse:</b>	PS/2 mouse identified.
<b>System BIOS shadowed</b>	System BIOS copied to shadow RAM.
<b>UMB upper limit segment address: <i>nnnn</i></b>	Displays the address <i>nnnn</i> of the upper limit of Upper Memory Blocks, indicating released segments of the BIOS which can be reclaimed by a virtual memory manager.
<b>Video BIOS shadowed</b>	Video BIOS copied to shadow RAM.

# OmniBook Diagnostic Program

The OmniBook hardware diagnostic program provides two levels of testing:

- User-level testing using the basic hardware test.
- Advanced testing using the individual hardware tests.

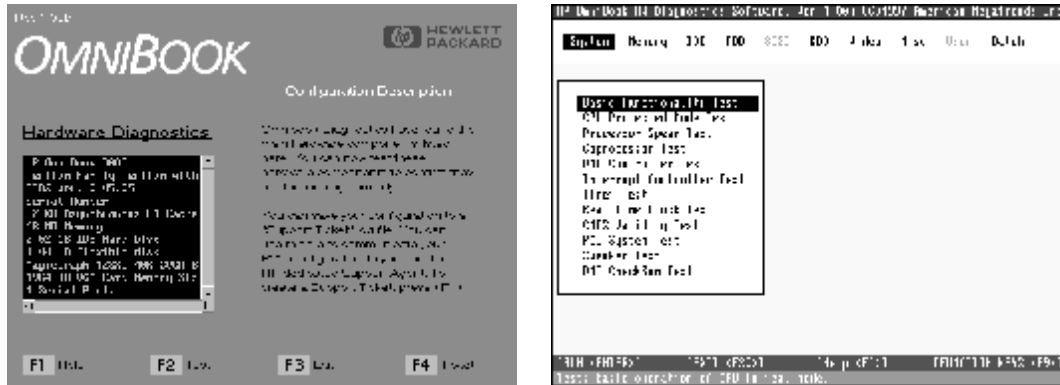

Figure 3-2. OmniBook Diagnostic Screens — Basic and Advanced

The tests are designed to run after the system reboots. This ensures that the OmniBook will be in a predictable state, so the diagnostic program can properly test the hardware components. The tests are non-destructive and are intended to preserve the state of the OmniBook. The OmniBook reboots when you exit the program so drivers can be loaded.

## Creating a Diagnostic Floppy Disk

### Note

You must create the diagnostic disk on an OmniBook Sojourn. It does not need to be created on the OmniBook Sojourn on which you will run the diagnostics.

After inserting a formatted floppy disk in the floppy drive, do one of the following to create a diagnostic floppy disk:

- On an OmniBook Sojourn with a factory software installation, run **diaginst** from the \Dmi\Hpdiags directory on the hard disk.
- On any OmniBook Sojourn, run **diaginst** from the \OmniBook\Dmi\Hpdiags directory on the OmniBook Sojourn Recovery CD.
- On any OmniBook Sojourn with World Wide Web access, download the diagnostic software package from the OmniBook website (see page v), run this file to unpack the files, then run **diaginst** to create the diagnostic disk.



## Running the Diagnostic Test

### CAUTION

Disconnect any external monitor before running the diagnostic tests. The LCD test is designed to work only with the LCD and could damage your external monitor.

1. Insert the diagnostic disk in the floppy drive.
2. Reboot the OmniBook.
3. Go through the first several screens.
4. When the hardware detection finishes, check the list of detected hardware. The following information and devices should be listed if applicable:

Product name	Main memory	Floppy drives
BIOS version	Graphics adapter	IDE drives
Processor type	Display name	SoundBlaster audio device
Cache memory		

### Note

If a device is not detected or fails its test below, it may be configured incorrectly in the BIOS Setup utility (page 3-26). You can confirm the problem by running BIOS Setup and checking the settings.

To run the serial and parallel (COMM and LPT1) port tests, you must set the OS Legacy Mode Support setting to No in the BIOS Setup utility. Otherwise the diagnostic program will not see these ports.

1. **Run the basic test.** Press F2 to start the basic hardware test.
2. If you intend to exit without running advanced tests, press F4 to save system and test information in the Support Ticket log file, HPSUPPT.TXT. Then remove the diagnostic disk and press F3 to exit.
3. **Run the advanced tests.** Press F2 to open the advanced test screen.
4. Select and run the appropriate tests. Tests are not listed if no such hardware is detected. Press the following keys to run tests:

ENTER	Runs the highlighted test.
F5 or SPACE	Marks or unmarks the highlighted test.
F6	Marks or unmarks all tests in the current menu.
F7	Marks or unmarks all tests in all menus.
F10	Runs all marked tests.

If any test fails, the error is logged (error code and description) and displayed temporarily (error code). If several errors occur, look for patterns that might indicate a common cause. See the table on 3-21 for repair suggestions. Consider these suggestions in combination with other troubleshooting information.

5. When you are finished running tests, press ESC to exit the advanced tests.
6. Press F4 to save system and test information in the Support Ticket log file, HPSUPPT.TXT.
7. **Exit.** Press F3 to exit and reboot.
8. **Optional: Check the log.** On any OmniBook, open the HPSUPPT.TXT log file on the diagnostic disk using Notepad or other text editor. It contains a hardware summary and a list of all test results and errors.

**Note**

- To test the serial and parallel ports, go into BIOS setup (see page 3-27) and make sure both are set to "Enabled" in the Advanced menu.
- To enable the suspend/resume test to work, go into the Power Savings menu in BIOS setup and set Switch Button to "Sus/Res" and set Resume On Time to "On".
- If you want to test IR, enable "serial B port" in the Advanced menu in BIOS setup and set the mode to "FIR". Also make sure that the parallel port mode is not "ECP" (there would be a DMA conflict).

Note that the serial and parallel port tests are more thorough if you connect a loopback connector to the port before running the test for that port. See the wiring diagrams below.

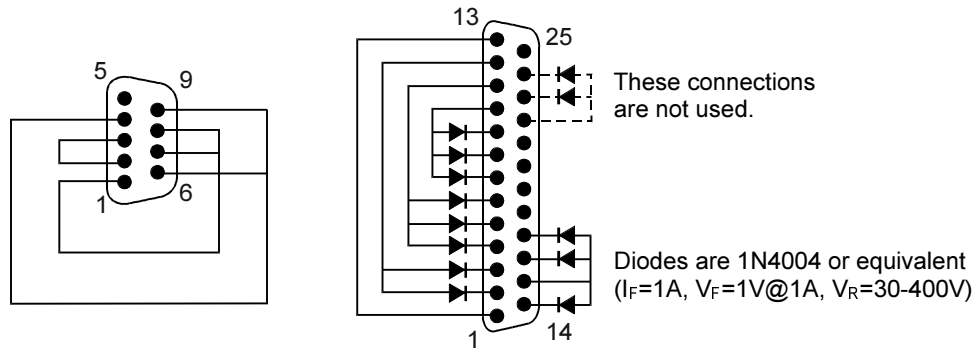

**Figure 3-3. Serial and Parallel Loopback Connectors**

## Interpreting the Results

- The following table lists test groups, error codes, and suggestions for follow-up actions. Consider these suggestions in combination with other troubleshooting information.

**Table 3-5. OmniBook Diagnostic Error Codes**

Code	Explanation	Recommended Action
<b>System Tests</b>		
0001h	Cannot load the MSW (Machine Status Word).	Exchange OmniBook Sojourn.
0002h	Cannot load the GDT (Global Descriptor Table) Register.	Exchange OmniBook Sojourn.
0003h	Cannot load the IDT (Interrupt Descriptor Table) Register.	Exchange OmniBook Sojourn.
0004h	ARPL instruction execution error.	Exchange OmniBook Sojourn.
0005h	LAR (Load Access Rights Byte) instruction execution error.	Exchange OmniBook Sojourn.
0006h	LSL (Load Segment Limit) instruction execution error.	Exchange OmniBook Sojourn.
0007h	VERR (Verify a Segment for Reading) instruction execution error.	Exchange OmniBook Sojourn.
0008h	VERW (Verify a Segment for Writing) instruction execution error.	Exchange OmniBook Sojourn.
0009h	Cannot enable the A20 line.	Exchange OmniBook Sojourn.
0010h	32-bit register read or write error.	Exchange OmniBook Sojourn.
0011h	PUSHA(D) or POPA(D) execution error.	Exchange OmniBook Sojourn.
0012h	Cannot access data through the FS or GS registers.	Exchange OmniBook Sojourn.
0013h	BSF or BSR execution error.	Exchange OmniBook Sojourn.
0014h	FLAG Register Set or Reset error.	Exchange OmniBook Sojourn.
0015h	Protected mode instruction execution error.	Exchange OmniBook Sojourn.
0016h	32-bit multiplication error.	Exchange OmniBook Sojourn.
001Eh	The detected CPU speed is not the same as specified.	Exchange OmniBook Sojourn.
0020h	NDP not ready.	Exchange OmniBook Sojourn.
0021h	Cannot reset the NDP.	Exchange OmniBook Sojourn.
0022h - 0025h	NDP control word read or write error.	Exchange OmniBook Sojourn.
0026h	Cannot reset the NDP control word.	Exchange OmniBook Sojourn.
0027h	NDP Tag word read or write error.	Exchange OmniBook Sojourn.
0028h	NDP stack read or write error.	Exchange OmniBook Sojourn.
0029h - 002Ah	NDP operation status handling error.	Exchange OmniBook Sojourn.
002B	Integer load or store error.	Exchange OmniBook Sojourn.
002Ch	NDP Tag word read or write error.	Exchange OmniBook Sojourn.
002Dh	NDP stack pop error.	Exchange OmniBook Sojourn.
002Eh - 002Fh	NDP Tag word read or write error.	Exchange OmniBook Sojourn.
0030h	Read/Write test on DMA controller 1 failed.	Exchange OmniBook Sojourn.
0031h	Read/Write test on DMA controller 2 failed.	Exchange OmniBook Sojourn.
0032h	Read/Write test on page registers failed.	Exchange OmniBook Sojourn.

<b>Code</b>	<b>Explanation</b>	<b>Recommended Action</b>
<b>System Tests (Continued)</b>		
0040h	Read/Write test on PIC ports failed.	Exchange OmniBook Sojourn.
0041h	Stray or unrecognized interrupts detected.	Run BIOS Setup and check IRQ assignments for all devices. Exchange OmniBook Sojourn.
0050h	The Timer Periodic Interrupt is not being generated.	Exchange OmniBook Sojourn.
0051h	The Timer is counting at a slower rate. Compared against the Real Time Clock, the timer counter rate is slower.	Exchange OmniBook Sojourn.
0052h	The Timer is counting at a faster rate. Compared to the Real Time Clock, the timer counter rate is faster.	Exchange OmniBook Sojourn.
0060h	The Real Time Clock Periodic Interrupt is not being generated.	Exchange OmniBook Sojourn.
0061h	The Real Time Clock is running at a slower rate. Compared to the system timer, the Real Time Clock is running at a slower rate.	Exchange OmniBook Sojourn.
0062h	The Real Time Clock is running at a faster rate. Compared to the system timer, the Real Time Clock is running at a faster rate.	Exchange OmniBook Sojourn.
0063h	The date and time read from Real Time Clock CMOS RAM are different from that written.	Exchange OmniBook Sojourn.
0071h	Bad CMOS RAM checksum detected.	Reset the system, then run BIOS Setup and check settings. Exchange OmniBook Sojourn.
0072h	Configuration mismatch in CMOS RAM.	Reset the system, then run BIOS Setup and check settings. Exchange OmniBook Sojourn.
0073h	CMOS RAM memory size information is invalid.	Reset the system, then run BIOS Setup and check settings. Exchange OmniBook Sojourn.
0074h	CMOS RAM time is invalid.	Reset the system, then run BIOS Setup and check settings. Exchange OmniBook Sojourn.
0075h	Time-base frequency divider set at incorrect value.	Reset the system. Exchange OmniBook Sojourn.
0076h	Divider output frequency set to an incorrect value.	Reset the system. Exchange OmniBook Sojourn.
0077h	Periodic time update cycle not occurring.	Exchange OmniBook Sojourn
0078h	CMOS RAM checksum error detected.	Reset the system, then run BIOS Setup and check settings. Exchange OmniBook Sojourn.
0079h	CMOS RAM fails to hold data.	Exchange OmniBook Sojourn.
0083h	PCI System Bus scan test failed.	Exchange OmniBook Sojourn.
0084h	Cannot access PCI devices through the FIND_PCI_DEVICE call.	Exchange OmniBook Sojourn.
0085h	Reading configuration space registers on boundary conditions failed.	Exchange OmniBook Sojourn.
0086h	Consistency checking of PCI configuration space failed.	Exchange OmniBook Sojourn.

Code	Explanation	Recommended Action
<b>System Tests (Continued)</b>		
0087h	GENERATE_SPECIAL_CYCLE check failed.	Exchange OmniBook Sojourn.
0088h	BIOS32 service directory integrity check failed.	Exchange OmniBook Sojourn.
0090h	PnP Function 00 failed.	Exchange OmniBook Sojourn.
0091h	PnP Function 01 failed.	Exchange OmniBook Sojourn.
0094h	The system device node number is not the same as reported.	Exchange OmniBook Sojourn.
0095h	The size of one or more nodes is larger than reported.	Exchange OmniBook Sojourn.
0096h	The ISA bus was detected twice.	Exchange OmniBook Sojourn.
009Ah	PnP Function 40 failed.	Exchange OmniBook Sojourn.
009Bh	Invalid number of PnP adapter cards.	Exchange OmniBook Sojourn.
009Ch	One or more unknown PnP adapter cards.	Exchange OmniBook Sojourn.
009Dh	No PCI system device node found.	Exchange OmniBook Sojourn.
009Eh	Too many PCI buses.	Exchange OmniBook Sojourn.
009Fh	Not enough DOS Applications memory available.	Load fewer device drivers.
00A0h	PnP Function 41 failed.	No Action needed. (ESCD not supported).
00A1h	The NVRAM buffer size is too large.	Exchange OmniBook Sojourn.
00A2h	ESCD size too small.	No Action needed. (ESCD not supported).
00A3h	ESCD size too large.	No Action needed. (ESCD not supported).
00A4h	NVRAM base address invalid.	Exchange OmniBook Sojourn.
00A5h	PnP Function 42 failed.	No Action needed. (ESCD not supported).
00A6h	PnP Function 43 failed.	No Action needed. (ESCD not supported).
00A7h	NVRAM test failed.	Exchange OmniBook Sojourn.
00FFh	Out of memory.	Rerun the test. Possible diagnostic programming error.
<b>Memory Tests</b>		
0100h	ROM read error.	Exchange OmniBook Sojourn.
0101h	ROM not write protected.	Exchange OmniBook Sojourn.
0102h	BIOS cannot set year to 2000 after 1999.	Exchange OmniBook Sojourn.
0120h	Parity error.	Exchange OmniBook Sojourn.
0130h	Different pattern read back from address then was written to the address.	Test without Cache ON. Exchange OmniBook Sojourn.
0131h	Parity error during pattern test.	Exchange OmniBook Sojourn.
0135h	ECC error detected.	Exchange OmniBook Sojourn.
0140h	Address failure.	Exchange OmniBook Sojourn.
0150h	Address failure	Exchange OmniBook Sojourn.
0160h	Address bus short.	Exchange OmniBook Sojourn.
0170h - 0172h	RAM refresh circuitry not working properly.	Exchange OmniBook Sojourn.
0180h	Different pattern read back from address then was written to the address.	Exchange OmniBook Sojourn.
0181h	No active external cache memory.	Enable external cache memory through the BIOS Setup utility and retest.
0182h	No extended memory available from HIMEN.SYS	Make sure that another application is not using all extended memory allocated by HIMEM.SYS.
0183h	No detected extended memory.	Exchange OmniBook Sojourn.
0190h	Test failed at address xxxxxxxh.	Exchange OmniBook Sojourn.

01A0h	Different pattern read back from address then was written to the address.	Exchange OmniBook Sojourn.
<b>Hard Disk Tests</b>		
0201h	Undefined or invalid command.	Exchange OmniBook Sojourn.
0202h	Address mark not found.	Rerun the test, If the error persists, exchange the OmniBook Sojourn.
0204h	Requested sector not found.	Rerun the test, If the error persists, exchange the OmniBook Sojourn.
0205h	Reset failed.	Exchange OmniBook Sojourn.
0207h	Drive parameter activity failed.	Run BIOS Setup and check the hard disk type. Exchange OmniBook Sojourn.
0208h	DMA Overrun error.	Rerun the test.
0209h	A DMA transfer at a 64 KB segment boundary was rejected by the drive controller BIOS.	Rerun the test.
020Ah	Bad sector flag detected. A sector previously marked bad was tested.	Rerun the test. Run SCANDISK or equivalent.
0210h	CRC (Cyclic Redundancy Check) or ECC data error.	Rerun the test. Run SCANDISK or equivalent.
0211h	ECC (Error Checking and Correction)-corrected data error.	Rerun the test. Run SCANDISK or equivalent.
0220h	Controller failure.	Exchange OmniBook Sojourn.
0240h	SEEK operation failed.	Exchange OmniBook Sojourn.
0280h	Drive not ready.	Exchange OmniBook Sojourn.
0281h	All Sectors in Test Cylinder are bad.	Exchange OmniBook Sojourn.
02AAh	Drive not ready.	Exchange OmniBook Sojourn.
02CCh	Bit 5 (write error bit) of the hard disk controller status register is set on completion of a write operation.	Exchange OmniBook Sojourn.
02EEh	The Performance test was run on a drive with less than 200 cylinders.	For the performance test, run BIOS Setup and temporarily select a drive type that has more than 200 cylinders.
02F1h -	Error reading partition table or no valid partition.	Recreate the Hibernate partition, then run FDISK to partition the hard disk.
02F2h	Disk data read/write error. The data pattern written to the disk and the data read back from the disk do not match.	Run FDISK to make one partition active. If necessary, recreate the Hibernate partition, then run FDISK to partition the hard disk.
02F3h	Partitions are overlapping.	Run FDISK to check for overlapping partitions. If necessary, recreate the Hibernate partition, then run FDISK to partition the hard disk.
02F4h	Boot Sector bootstrap pgm incorrect or virus infection.	Check for presence of a boot sector virus. If necessary, recreate the Hibernate partition, then run FDISK to partition the hard disk.
02F5h	Media descriptor is invalid.	Reformat the partition.
02F6h	Total sector number in partition table and boot sector differ.	Recreate the Hibernate partition, then run FDISK to partition the hard disk.
02FFh	Disk data read/write error.	Exchange OmniBook Sojourn.
<b>Floppy Disk Tests</b>		
0301h	Undefined or invalid command.	Exchange OmniBook Sojourn.
0302h	Address mark not found.	Run BIOS Setup and check the floppy drive type.

		If test still fails, exchange multimedia slice.
0303h	Disk is write-protected.	Insert a floppy disk without write protection.
0304h	Requested sector not found.	Run BIOS Setup and check the floppy drive type. If test still fails, exchange OmniBook Sojourn.
0305h	Reset failed.	Exchange multimedia slice.
0307h	Drive parameter activity failed.	Run BIOS Setup and check the floppy drive type. If test still fails, exchange multimedia slice.
0308h	DMA Overrun error.	Transient DMA error. Rerun the test. If test still fails, exchange multimedia slice.
0309h	Attempt to DMA at 64 KB boundary	Transient DMA error. Rerun the test.
030Ah	Bad sector flag detected.	Rerun the test with a good floppy disk. If test still fails, exchange multimedia slice.
0310h	CRC or ECC data error.	Rerun the test with a good floppy disk. If test still fails, exchange multimedia slice.
0311h	ECC-corrected data error.	Rerun the test with another floppy disk.
0321h	Change line not working.	Exchange multimedia slice.
0322h	Floppy speed error disk.	Exchange multimedia slice.
0340h	Seek operation failed. An attempt to perform a seek operation failed.	Exchange multimedia slice.
0380h	Drive not ready.	Make sure the floppy disk is fully inserted and rerun test. If test still fails, exchange multimedia slice.
03AAh	Drive not ready.	Make sure the floppy disk is fully inserted and rerun test. If test still fails, exchange multimedia slice.
03CCh	Write fault on selected drive.	Run BIOS Setup and check the floppy drive type. Rerun the test with another floppy disk. If test still fails, exchange multimedia slice.
03EEh	Data write/data read mismatch.	Rerun the test with another floppy disk. If test still fails, exchange multimedia slice.
03FFh	Diskette data read/write error.	Rerun the test with another floppy disk. If test still fails, exchange multimedia slice.
<b>Keyboard Tests</b>		
0400h	Keyboard controller interface error.	Exchange OmniBook Sojourn.
0401h	Improper responses to the keyboard controller commands.	Exchange OmniBook Sojourn.
0410h - 0411h	Keyboard clock line is stuck low/high.	Exchange OmniBook Sojourn.
0412h - 0413h	Keyboard data line is stuck low/high.	Exchange OmniBook Sojourn.
0414h	No response or improper response to command to the keyboard.	Exchange OmniBook Sojourn.
0415h	Keyboard LED could not be turned on.	Exchange OmniBook Sojourn.
0416h	Keyboard diagnostic echo failed.	Exchange OmniBook Sojourn.
0417h	Keyboard is not responding to command.	Exchange OmniBook Sojourn.
0418h	Keyboard user prompt = failed.	Exchange OmniBook Sojourn.
<b>Serial Port Test</b>		
0601h	Data read back from the port xxxh was	For the external loopback test, make sure

	different from data written to port.	the loopback connector is installed and constructed properly. If test still fails, exchange OmniBook Sojourn or multimedia slice.
0602h	Interrupt identification register test failed.	Exchange OmniBook Sojourn.
0603h	Data read back from the port xxxh was different from data written to port.	For the external loopback test, make sure the loopback connector is installed and constructed properly. If test still fails, exchange OmniBook Sojourn or multimedia slice.
0604h	Line status register test failed at port xxxh.	Exchange OmniBook Sojourn.
0605h	Interrupt activation test failed at port xxxh.	Exchange OmniBook Sojourn.
0606h	Data transfer test failed at port xxxh.	For the external loopback test, make sure the loopback connector is installed and constructed properly. If test still fails, exchange OmniBook Sojourn or multimedia slice.
0607h	Loop back test failed at port xxxh.	For the external loopback test, make sure the loopback connector is installed and constructed properly. If test still fails, exchange OmniBook Sojourn or multimedia slice.
0608h	FIFO register test failed.	Exchange OmniBook Sojourn.
0609h	FIFO register test failed.	Exchange OmniBook Sojourn.
0610h	FIFO trigger level error.	Exchange OmniBook Sojourn.
0611h	FIFO test error.	Exchange OmniBook Sojourn.
<b>Parallel Port Test</b>		
0701h	Data read back from the port xxxh was different from data written to port.	For the external loopback test, make sure the loopback connector is installed and constructed properly. If test still fails, exchange OmniBook Sojourn or multimedia slice.
0702h	The IRQ activation test failed at port xxxh.	Exchange OmniBook Sojourn.
0703h	No response from printer.	Run BIOS Setup and disable ECP for the parallel port, then rerun the test. If test still fails, exchange OmniBook Sojourn.
0704h	ECP register W/R failed at port xxxh.	Exchange OmniBook Sojourn.
0705h	ECP FIFO test failed at port xxxh.	Exchange OmniBook Sojourn.
0706h	LPT data port test failed.	Exchange OmniBook Sojourn.
0707h	Loopback test failed at port xxxh.	For the external loopback test, make sure the loopback connector is installed and constructed properly. If test still fails, exchange OmniBook Sojourn or multimedia slice.
0708h	Non-expected data in the loopback circuit.	Exchange OmniBook Sojourn.
<b>Audio Test</b>		
0801h - 0804h	Sound test failed.	Exchange OmniBook Sojourn.
0810h	Speaker test failed.	Exchange OmniBook Sojourn.
0812h	Sound test failed.	Exchange OmniBook Sojourn.
<b>Video Test</b>		
0900h	Video adapter memory read or write test failed.	Exchange OmniBook Sojourn.



0901h	Video adapter attribute test failed.	Exchange OmniBook Sojourn.
0903h	80 x 25 video display test failed.	Exchange OmniBook Sojourn.
0904h	40 x 25 video display test failed.	Exchange OmniBook Sojourn.
0905h	320 x 200 graphics test failed.	Exchange OmniBook Sojourn.
0906h	640 x 200 graphics test failed.	Exchange OmniBook Sojourn.
0907h	Video memory page selection test failed.	Exchange OmniBook Sojourn.
0908h	Video adapter color test failed.	Exchange OmniBook Sojourn.
0909h	640 x 350 graphics test failed.	Exchange OmniBook Sojourn.
090Ah	640 x 480 graphics test failed.	Exchange OmniBook Sojourn.
090Ch	VESA video mode test failed.	Exchange OmniBook Sojourn.
090Dh	VESA video memory test failed.	Exchange OmniBook Sojourn.
090Eh	DDC1 protocol failed.	Exchange OmniBook Sojourn.
090Fh	DDC2 protocol failed.	Exchange OmniBook Sojourn.
<b>CD-ROM Tests</b>		
0A00h	No CD in drive.	Insert a CD in the drive.
0A01h	Eject fails on drive.	Manually eject CD.
0A02h	Close failed on drive.	Manually close CD.
0A03h	Data test failed.	Insert a different CD in the drive and rerun the test. If test still fails, exchange multimedia slice.
0A04h	Play test failed.	Insert a different CD in the drive and rerun the test. If test still fails, exchange multimedia slice.
0A05h	No data CD in drive.	Insert a computer CD in the drive.
0A06h	No audio CD in drive.	Insert an audio CD in the drive.
<b>USB Tests</b>		
1301h	Cannot find PCI resource.	Exchange OmniBook Sojourn.
1302h	Register test failed.	Exchange OmniBook Sojourn.
1303h	Frame test failed.	Exchange OmniBook Sojourn.
1304h	Status test failed.	Exchange OmniBook Sojourn.
1305h	Interrupt test failed.	Exchange OmniBook Sojourn.
1306h	Transfer description failed.	Exchange OmniBook Sojourn.
<b>OmniBook IR Tests (FIR enabled)</b>		
9002h	Can't find the PIIX4 chip.	Exchange OmniBook Sojourn.
9007h	SIR: Tx empty interrupt did not happen. MIR/FIR: Tx DMA did not generate an interrupt.	Exchange OmniBook Sojourn. Exchange OmniBook Sojourn.
9008h	Rx DMA w/o interrupts failed (wrong # bytes, bad bytes). MIR/FIR only.	Exchange OmniBook Sojourn.
9009h	Tried to run the test in Windows (must exit to DOS). No successful transmits. Internal loopback errors occurred.	Do not run this test in Windows. For the two-unit test, make sure the IR ports on the reflector and test OmniBooks are lined up. Rerun the test. If test still fails, exchange OmniBook Sojourn.
900Ah	Bad packet received or no packet at all: rear IR port.	Make sure the IR ports on the reflector and test OmniBooks are lined up and rerun the test. If test still fails, exchange OmniBook Sojourn.

900Ch	No packets received.	Make sure the IR ports on the reflector and test OmniBooks are lined up. Restart the reflector unit. Rerun the test. Exchange front OmniBook Sojourn
-------	----------------------	--

## BIOS Setup Utility

The BIOS Setup utility provides access to basic configuration settings. It is independent of the operating system.

### Running the BIOS Setup Utility

1. Close all applications, then shut down Windows and reboot the OmniBook.
2. When you see the HP logo, press F2 to enter the BIOS Setup utility.
3. The touch pad or mouse is not active in the Setup utility. Press the RIGHT and LEFT arrow keys to move among menus. Press the DOWN and UP arrow keys to move among parameters in a menu. Press ENTER to change a setting. See the tables below for more information.
4. After you select the options you want, press F10 to exit the Setup utility.

**Table 3-6. BIOS Setup Menus and Parameters**

Main Menu	Description	Default
System Time	Sets the time using 24-hour format.	00:00:00
System Date	Specify a time when the system is to wake up.	00/00/0000
Legacy Diskette A	Sets the floppy drive type.	1.44/1.25 MB
Primary Master	Sets parameters of drive attached to primary IDE adapter (hard disk drive).	2.1 GB HDD
Secondary Master	Sets parameters of drive attached to secondary IDE adapter (CD-ROM).	CD-ROM
Boot Options	Selects the order the system searches drives for a boot disk.	A: then C:
OS Legacy Mode Support	Select "Yes" if using a plug-and-play operating system such as Windows 95, otherwise select "No".	Yes
Numlock	Selects power-on state for Numlock.	Off
Memory Cache	Sets the CPU memory cache.	Enabled
System Memory	Shows the system memory size.	640 KB
Extended Memory	Shows the extended memory size.	64512 KB
CPU Type	Shows the CPU type.	Pentium with MMX
CPU Speed	Shows the CPU speed.	233 Mhz

Advanced Menu	Description	Default
I/O Device Configuration		
Serial Port A	Configures serial port A	Auto
Serial Port B Mode	Configures serial port B. Set mode (Normal, IrDA, ASK-IR, or FIR) for serial port B.	Disabled Normal
Parallel Port Mode	Configures parallel port. Sets mode (Output Only, bidirectional, ECP, or EPP) for parallel port.	Auto Bidirectional
Floppy Disk Controller	Configures floppy disk controller.	Enabled
Large Disk Access Mode	UNIX, Novell Netware, or other operating systems, select "Other."	DOS
Local Bus IDE adapter	Enables local bus IDE adapter.	Both

<b>Security Menu</b>	<b>Description</b>	<b>Default</b>
User Password Is	Shows if a user password is set.	Clear
Supervisor Password Is	Shows if a supervisor password is set.	Clear
Set User Password	Press ENTER to set, change, or clear the password and save all Setup changes. (Up to 8 alphanumeric keys).	
Set Supervisor Password	Press ENTER to set, change, or clear the password and save changes	
Password on Boot	Required a password to boot.	Disabled
Diskette Access	Restricts floppy drive use to supervisor. Requires setting Supervisor password and enabling Password On Boot.	Supervisor
Fixed Disk Boot Sector	Write protects boot sector on hard disk to protect against viruses.	Normal

<b>Power Saving</b>	<b>Description</b>	<b>Default</b>
Switch Button	Sets the Switch Button to Suspend/Resume or to On/Off.	Suspend/Resume
Power Management	Disables time-outs, selects a combination of time-outs, or allows customized time-outs.	Maximum Power Saving
Idle Mode	Turns Idle mode on and off. Idle mode slows down the CPU during brief periods when the system is not busy.	On
Standby Time-out	Sets the period of inactivity after which the OmniBook goes from Idle to Standby power mode.	1 minute
Suspend Mode	Sets the type of Suspend mode to Suspend-to-RAM or Save-to-Disk.	Save To Disk
Auto Suspend Time-out	Sets the period of inactivity after which the OmniBook goes from Standby to Suspend mode.	5 minutes
Hard Disk Time-out	Sets the period of hard disk inactivity after which the hard disk stops spinning.	1 minute
Video Time-out	Turns off the OmniBook screen after the set period of inactivity.	4 minutes
Resume on Modem Ring	When enabled, sets the system to resume when receiving a ring signal.	Off
Resume on Time	When enabled, sets the system to resume at Resume Time specified.	Off
Resume Time	Specify a time when the system is to resume (24-hour time format).	00:00:00
Resume Date	Specify a date when the system is to resume (mm/dd/yyyy format).	00/00/0000

Exit Menu	Description	Default
Exit Saving Changes	Saves Setup changes, exits, and reboots.	none
Exit Discarding Changes	Discards Setup changes since last save, exits, and reboots.	none
Load Setup Defaults	Restores all default settings, and stays in Setup.	none
Discard Changes	Discards Setup changes since last save, and stays in Setup.	none
Save Changes	Saves Setup changes, and stays in Setup.	none

---

## To change the keyboard layout

If the keys do not type the characters marked on them, the wrong keyboard layout may be selected.

- To change the setting in Windows 95, select Control Panel, Keyboard, Language tab, Properties, Keyboard Layout. Change the selection in the field.
- To effect the change in DOS, you must edit the AUTOEXEC.BAT and CONFIG.SYS files. To select the British keyboard layout, un-comment (remove the REM commands) from the two lines that activate the British keyboard. To select the United States 101 keyboard layout, delete the two command lines that activate the British keyboard.



## Reference Information

---

This chapter includes the following reference information:

- Password removal policy.
- TFT display quality statement.
- Replaceable parts list.

---

### Password Removal Policy

If the user forgets the system password, the user must return the OmniBook Sojourn to a service center for password removal. The user must provide proof of ownership.

The password removal procedure is protected as HP Company Private information. There are a restricted number of locations that can perform password removal. It may not be disclosed or distributed outside those locations.

Password removal is strictly controlled. Hewlett-Packard and authorized support providers must ensure with written evidence that the user returning the OmniBook to be “cleansed” is actually the property of the unit’s actual and current owner. This requires a sales receipt showing the unit serial number and owner’s name, or a written statement from the owner attesting that he or she is the owner of the unit. The statement can be a fax copy of the document. The fact that the unit is in the hands of an HP representative on behalf of the customer is not evidence of ownership. In addition, HP will not remove the password of a unit for any non-owner, even if it is requested by law enforcement agencies. If you receive such a request, you should notify management and HP Corporate Legal immediately. (These requests may require a court order prior to our participation.)

Further, the entity removing the password must log the name, serial number and date of the removal, and file the written backup with the log. The log and backup are subject to standard record retention process and review.

The final issue relating to removal of passwords is that HP cannot provide information to users that would assist them in improperly removing a password and opening a unit.

---

## Hewlett-Packard TFT Display Quality Statement

TFT display manufacturing is a high-precision but imperfect technology, and manufacturers cannot currently produce large displays that are cosmetically perfect. Most, if not all, TFT displays will exhibit some level of cosmetic imperfection. These cosmetic imperfections may be visible to the customer under varying display conditions and can appear as bright, dim, or dark spots. This issue is common across all vendors supplying TFT displays in their products and is not specific to the HP OmniBook display.

HP OmniBook TFT displays meet or exceed all TFT manufacturer's standards for cosmetic quality of TFT displays. HP does not warrant that the displays will be free of cosmetic imperfections. TFT displays may have a small number of cosmetic imperfections and still conform to the display manufacturer's cosmetic quality specifications.

Here are some guidelines to use in determining what action to take on customers' complaints of cosmetic imperfections in their TFT displays:

1. The unit should be viewed in the customer's normal operating condition.

This means if the customer uses the unit predominately in DOS, in Windows, or in some other application or combination of applications, that is where you should make the determination. Self test is not a normal operating condition and is not a sufficient tool to interpret display quality.

2. Use the table below to determine whether the display should be considered defective.
3. If a OmniBook Sojourn is considered for replacement because of display defects, it should be clear to the customer that cosmetic variations on the replacement display may also exist, and may require the customer to use a work-around to obscure the cosmetic imperfection.
4. Customers with cosmetic-based complaints only, which do not conform to the above conditions and tests, will not normally be considered for OmniBook Sojourn replacement. It will be left to the judgment of the HP-responsible person working with the customer, to identify work-arounds that are reasonable and appropriate for the individual customer

We expect over time that the industry will continue to improve in its ability to produce displays with fewer inherent cosmetic imperfections, and we will adjust our HP guidelines as the improvements are implemented.



**Table 4-1. OmniBook Sojourn TFT XGA Display Quality Guidelines**

Type of Imperfection	Imperfections Not Allowed
Electrical Imperfections: Bright dots (a) Dark dots (a)	9 or more single bright dots. 3 or more occurrences of double (two vertically adjacent) bright dots. 3 or more occurrences of two single or double bright dots within 15 mm. 9 or more single or double dark dots. 3 or more occurrences of double (two vertically adjacent) dark dots. 3 or more occurrences of two single or double dark dots within 15 mm. Any occurrence of 3 or more vertically adjacent bright dots. Any occurrence of 3 or more vertically adjacent dark dots.
Mechanical Imperfections: Spots (b) Lines (c) Polarizer scratches (d) Polarizer dents, bubbles (e)	6 or more spots 0.25-0.5 mm avg. dia. 6 or more lines 1.0-10 mm long and 0.01-0.05 mm wide. 6 or more dents or bubbles 0.25-0.5 mm avg. dia. Any spot over 0.5 mm dia. Any line over 10 mm long or 0.05 mm wide. Any scratch noticeable from 30 cm (12 in) under normal office lighting. Any dent or bubble over 0.5 mm avg. dia.
Definitions of imperfections: <sup>a</sup> Bright or dark dot: A subpixel (red, green, or blue dot) that is stuck on or off. <sup>b</sup> Spot: A point on the display that appears dark or bright and does not change in size. Caused by foreign circular matter on the backlight. <sup>c</sup> Line: A line on the display that appears dark or light, and does not change in size. Caused by contamination (lint, hair) behind the display. <sup>d</sup> Polarizer scratch: A light line that is visible on a darker background and does not change in size. <sup>e</sup> Polarizer dent or bubble: A light spot with a darker border that appears on a lighted display and does not change in size.	

---

## OmniBook Sojourn Replaceable Parts

Table 4-2. OmniBook Sojourn Replaceable Parts List

Part Number	Exchange Part Number	Description
F1430-60901	F1430-69001	OmniBook Sojourn
F1430-60902	CREW*	Recovery CD-ROM
F1431-60901	F1431-69001	Multimedia Slice
F1432-60901	F1432-69001	Battery, Internal
F1433-60901	F1433-69001	Enhanced Battery Slice
F1430-60905	CREW	Additional ac adapter
F1430-60909	CREW	Auto/airline power adapter
* Customer Replaceable End User Warranty		



- 1. Product Information**
- 2. Battery Replacement**
- 3. Troubleshooting and Diagnostics**
- 4. Reference Information**