OmniBook 2000/5700

Installation and Setup Guide

Notice

This manual and any examples contained herein are provided “as is” and are subject to change without notice. Hewlett-Packard Company makes no warranty of any kind with regard to this manual, including, but not limited to, the implied warranties of merchantability and fitness for a particular purpose. Hewlett-Packard Co. shall not be liable for any errors or for incidental or consequential damages in connection with the furnishing, performance, or use of this manual or the examples herein.

Consumer transactions in Australia and the United Kingdom: The above disclaimers and limitations shall not apply to Consumer transactions in Australia and the United Kingdom and shall not affect the statutory rights of Consumers.

© Copyright Hewlett-Packard Company 1997. All rights reserved. Reproduction, adaptation, or translation of this manual is prohibited without prior written permission of Hewlett-Packard Company, except as allowed under the copyright laws.

The programs that control this product are copyrighted and all rights are reserved. Reproduction, adaptation, or translation of those programs without prior written permission of Hewlett-Packard Co. is also prohibited.

Portions of the programs that control this product may also be copyrighted by Microsoft Corporation, SystemSoft Corp., Advanced Micro Devices, Inc., Crystal Semiconductor Corporation, and Chips & Technologies, Inc. See the individual programs for additional copyright notices.

Microsoft, MS, MS-DOS, and Windows are registered trademarks of Microsoft Corporation (U.S. patent numbers 4955066 and 4974159). Pentium is a U.S. registered trademark of Intel Corporation. TrackPoint is a U.S. trademark of International Business Machines.

For warranty information, see the *Support and Service* booklet.

Hewlett-Packard Company
Mobile Computing Division
1000 N.E. Circle Blvd.
Corvallis, OR 97330, U.S.A.

HP Software Product License Agreement

Your HP OmniBook PC contains factory-installed software programs. Please read the Software License Agreement before proceeding.

Carefully read this License Agreement before proceeding to operate this equipment. Rights in the software are offered only on the condition that the customer agrees to all terms and conditions of the License Agreement. Proceeding to operate the equipment indicates your acceptance of these terms and conditions. If you do not agree with the terms of the License Agreement, you must now either remove the software from your hard disk drive and destroy the master diskettes, or return the complete computer and software for a full refund.

Proceeding with configuration signifies your acceptance of the License Terms.

Unless otherwise stated below, this HP Software Product License Agreement shall govern the use of all software that is provided to you, the customer, as part of the HP computer product. It shall supersede any non-HP software license terms that may be found online, or in any documentation or other materials contained in the computer product packaging.

Note: Operating System Software by Microsoft is licensed to you under the Microsoft End User License Agreement (EULA) contained in the Microsoft documentation.

The following License Terms govern the use of the software:

Use. Customer may use the software on any one computer. Customer may not network the software or otherwise use it on more than one computer. Customer may not reverse assemble or decompile the software unless authorized by law.

Copies and Adaptations. Customer may make copies or adaptations of the software (a) for archival purposes or (b) when copying or adaptation is an essential step in the use of the software with a computer so long as the copies and adaptations are used in no other manner.

Ownership. Customer agrees that he/she does not have any title or ownership of the software, other than ownership of the physical media. Customer acknowledges and agrees that the software is copyrighted and protected under the copyright laws. Customer acknowledges and agrees that the software may have been developed by a third party software supplier named in the copyright notices included with the software, who shall be authorized to hold the Customer responsible for any copyright infringement or violation of this Agreement.

Product Recovery CD-ROM. If your computer was shipped with a product recovery CD-ROM: (i) The product recovery CD-ROM and/or support utility software may only be used for restoring the hard disk of the HP computer with which the

product recovery CD-ROM was originally provided. (ii) The use of any operating system software by Microsoft contained in any such product recovery CD-ROM shall be governed by the Microsoft End User License Agreement (EULA).

Transfer of Rights in Software. Customer may transfer rights in the software to a third party only as part of the transfer of all rights and only if Customer obtains the prior agreement of the third party to be bound by the terms of this License Agreement. Upon such a transfer, Customer agrees that his/her rights in the software are terminated and that he/she will either destroy his/her copies and adaptations or deliver them to the third party.

Sublicensing and Distribution. Customer may not lease, sublicense the software or distribute copies or adaptations of the software to the public in physical media or by telecommunication without the prior written consent of Hewlett-Packard.

Termination. Hewlett-Packard may terminate this software license for failure to comply with any of these terms provided Hewlett-Packard has requested Customer to cure the failure and Customer has failed to do so within thirty (30) days of such notice.

Updates And Upgrades. Customer agrees that the software does not include updates and upgrades which may be available from Hewlett-Packard under a separate support agreement.

Export Clause. Customer agrees not to export or re-export the software or any copy or adaptation in violation of the U.S. Export Administration regulations or other applicable regulation.

U.S. Government Restricted Rights. Use, duplication, or disclosure by the U.S. Government is subject to restrictions as set forth in subparagraph (c)(1)(ii) of the Rights in Technical Data and Computer Software clause in DFARS 252.227-7013. Hewlett-Packard Company, 3000 Hanover Street, Palo Alto, CA 94304 U.S.A. Rights for non-DOD U.S. Government Departments and Agencies are as set forth in FAR 52.227-19(c)(1,2).

Edition History

Edition 1 April 1997



This manual is printed on recycled paper.

Contents

1. Starting Out with Your OmniBook	1-1
Setting Up the OmniBook	1-3
To set up the OmniBook	1-3
To select one of the factory-installed operating systems	1-4
Getting Comfortable	1-7
A tour of the OmniBook	1-8
To adjust the display	1-9
To use the pointing device	1-9
To adjust the OmniBook keyboard	1-10
To adjust the speaker volume	1-11
To connect a microphone, speakers, or headphones	1-11
To start the OmniBook	1-12
To stop the OmniBook	1-12
To reset and restart the OmniBook	1-16
To understand the status panel	1-17
To attach a security cable	1-18
Using OmniBook Accessories	1-19
To remove accessories from the OmniBook	1-20
To install the floppy disk drive	1-21
To insert and eject a floppy disk	1-22
To install the CD-ROM drive	1-23
To insert and remove a CD	1-24
To use the CD-ROM drive safely	1-25
To replace the battery	1-26
To install a high-capacity battery	1-27
To handle and store the battery safely	1-28
To maintain and preserve battery life	1-28
To insert a PC card	1-29
To remove a PC card	1-30
Where to Go from Here	1-31
2. Installing an Operating System	2-1
What the Recovery CD Contains	2-3
Reinstalling Windows 95	2-4
To reinstall Windows 95	2-4
Reinstalling Windows for Workgroups	2-6
To reinstall Windows for Workgroups	2-6

To make DOS 6.22 and Windows for Workgroups disks	2-7
To install Windows for Workgroups drivers	2-8
Installing Windows NT or OS/2 Warp	2-9
To install Windows NT or OS/2 Warp	2-9
Installing HP Applications	2-10
To install HP software programs	2-10
3. Expanding the OmniBook	3-1
Replacing Hardware	3-3
To remove the hard disk drive	3-3
To install the hard disk drive	3-4
To find the system software version and memory size	3-4
To add memory to the OmniBook	3-5
Connecting Devices	3-7
To connect an external monitor	3-8
To adjust the display type	3-8
To turn off the built-in display	3-9
To connect a printer	3-9
To install a printer	3-9
To connect an external mouse or keyboard	3-10
To connect both a mouse and keyboard	3-10
To enable the Fn keys	3-11
To connect a serial device	3-11
To view or change serial port assignments	3-11
To specify serial port settings	3-12
To connect a parallel device	3-13
To view or change parallel port assignments	3-13
To make an infrared connection	3-14
To print on an infrared printer	3-14
To set up a PC card or parallel port CD-ROM drive	3-15
4. Changing the Configuration	4-1
Changing the Configuration	4-3
Using HP User Tools	4-4
To run HP User Tools	4-4
Using OmniBook Tools	4-6
To run OmniBook Tools	4-6
Using the System Configuration Utility	4-8
To run the SCU (during reboot)	4-8
To run the SCU without rebooting	4-8

5. Troubleshooting	5-1
Solving Basic Problems	5-3
6. Specifications and Regulatory Information	6-1
Hardware Specifications	6-3
Software System Resources	6-4
Safety Information	6-6
Working in Comfort	6-9
Regulatory Information	6-10
U.S.A.	6-10
Canada	6-11
Japan	6-11
Europe	6-12

**Starting Out with Your
OmniBook**

Starting Out with Your OmniBook

Congratulations! Your OmniBook sets a new standard in personal computing. Although it's compact and easy to carry, the OmniBook is infused with the quality and attention to detail that are the hallmark of Hewlett-Packard.

The OmniBook *Quick Start* sheet shows how to get your OmniBook up and running quickly. This *Getting Started* manual shows how to start using your OmniBook and it also shows what to do if you run into trouble.

Your OmniBook provides these additional manuals:

- The online OmniBook *User's Guide* : This introduces the OmniBook and shows you how to operate and maintain your OmniBook. It also contains troubleshooting information. Look in the OmniBook Library group.
- The *Introducing Microsoft Windows 95* manual: This is shipped with your OmniBook and contains information about using the standard features of Windows 95.
- The online *Windows Quick Start* and *MS-DOS Quick Start* manuals: These are in the OmniBook Library group for Windows® for Workgroups.
- The OmniBook Website at <http://www.hp.com/go/omnibook>
The *Corporate Evaluator's Guide* at our Website provides complete information about installing alternate operating systems, as well as how to configure the OmniBook in a corporate, networked environment.

Setting Up the OmniBook

This chapter describes the first-time setup of your HP OmniBook hardware, including the following:

- ◆ Installing the battery.
- ◆ Connecting the ac adapter and charging the battery.
- ◆ Selecting a factory-installed operating system.

To set up the OmniBook

1. Insert the battery. *Use only an HP F1193B battery (or super F1194B).*

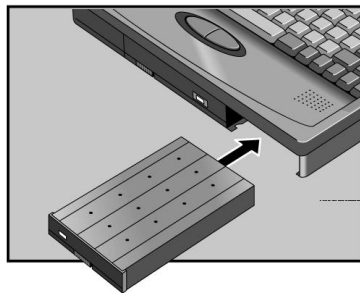

2. Plug the power cord into the ac adapter, then into a grounded outlet.

CAUTION

Use only an HP F1140A or HP F1044B ac adapter. Using an improper adapter could damage the OmniBook and will make your warranty invalid.

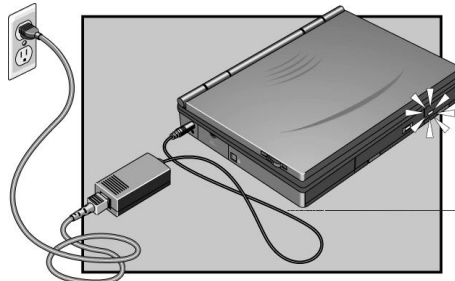

Starting Out with Your OmniBook
Setting Up the OmniBook

CAUTION

The first time you plug in the ac adapter, let the OmniBook charge continually for at least 24 hours. This ensures that the OmniBook's clock battery is fully charged. Otherwise, your OmniBook will not keep the correct date and time. Subsequent charging of the primary battery, during normal use, will maintain the clock battery's charge.

CAUTION

The HP F1044B ac adapter used with this product is disconnected from the power by unplugging the power cord from the power outlet or from the ac adapter. Therefore, the power outlet should be located close to the product and be easily accessible.

3. Press the blue On/Suspend button.

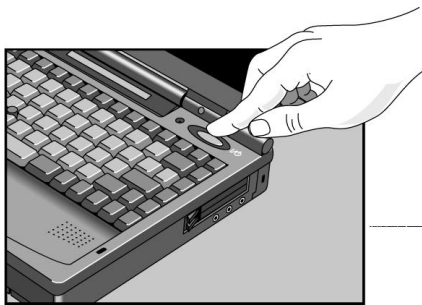

The OmniBook will take half a minute or more to start. If the OmniBook does not turn on, press the Off button on the left side of the OmniBook, then press the blue button again.

To select one of the factory-installed operating systems

This product offers a choice between two Microsoft operating systems:

- Windows 95, or
- Windows for Workgroups.

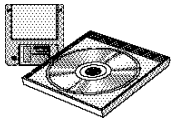

Recovery CD

As part of the setup procedure, you must make a *one-time, final* selection of the operating system you want to use. Once made, this selection can be changed *only* by purchasing new copies of DOS 6.22 and Windows for Workgroups. (Windows 95 is included on the *Recovery CD-ROM*.)

Should you later need to reinstall the operating system, you can reinstall Windows 95 from the *Recovery CD*—or Windows for Workgroups from retail disks, which you purchase. *Instructions for reinstalling an operating system are in chapter 2 of this manual.*

When your OmniBook starts up the first time, it takes you through a series of setup screens, including installation of the operating system.

Important

If you have a docking system, you should *not* have it connected during the installation of the operating system.

If you're installing Windows for Workgroups

CAUTION

When prompted to do so, it is important that you make back-up installation disks for MS-DOS and Windows for Workgroups. This will require 12 floppy disks—eight disks for Windows and four for MS-DOS 6.22. (The back-up program will format the disks. You will need these installation disks to install certain drivers (such as printers and networks), as well as to recover your operating system in case of a failure. If you do not make these disks, you will need to purchase your own copies of MS-DOS 6.22 and Windows for Workgroups. (You can make these back-up disks at any time from the icon in the Windows OmniBook group.)

1. Plug in the ac adapter.
2. Press the blue On/Suspend button.

The Windows 95 Setup program starts automatically. The Setup screens are labeled Windows 95, but they are for Windows for Workgroups, too.

After you accept the License Agreement and enter the Product ID (printed on the Certificate of Authenticity on the Microsoft *Introducing Windows 95* book), you will see the Windows Version screen. *If you choose Windows for Workgroups, the product ID is not necessary.*

Starting Out with Your OmniBook
Setting Up the OmniBook

3. In the Windows Version screen, click the Change button.



4. Choose the following option:
No, I want to install MS-DOS 6.22 and Microsoft Windows for Workgroups 3.11
5. Click OK to continue the Setup program and install Windows for Workgroups.

Getting Comfortable

This section introduces the OmniBook and shows you how perform some basic tasks. In this section you'll learn how to

- ◆ Identify parts of the OmniBook.
- ◆ Adjust the display.
- ◆ Use the TrackPoint III pointing device.
- ◆ Adjust and use the OmniBook keyboard features.
- ◆ Adjust the volume of the OmniBook.
- ◆ Connect a microphone, speaker, or headphones.
- ◆ Start and stop the OmniBook.
- ◆ Reset the OmniBook.
- ◆ Understand the status panel symbols.
- ◆ Attach a security cable to the OmniBook.
- ◆ Get more information about using the OmniBook.

A tour of the OmniBook

The following illustrations point out key parts of the OmniBook.

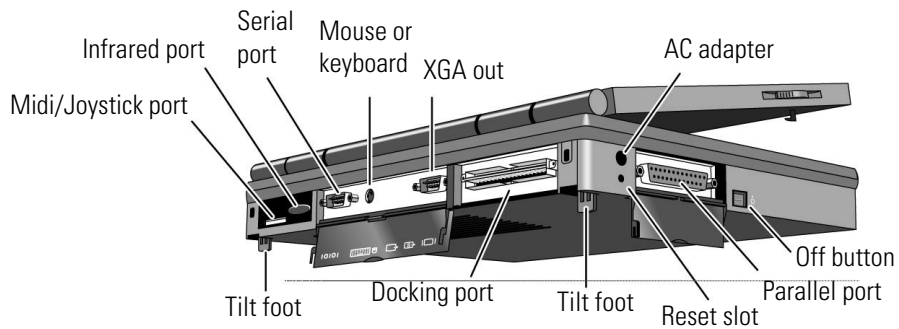

To adjust the display

-  Brightness
-  Contrast

All OmniBooks are equipped with a brightness control. Some models also have a contrast control. The display controls are located to the right of the display.

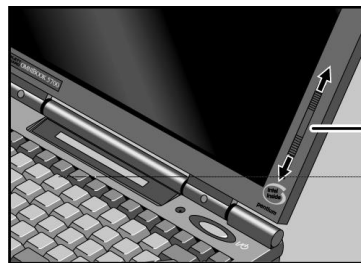

To increase brightness or contrast, slide the controls up.
To decrease, slide down.

To use the pointing device

The pointing device controls the motion of the pointer on the screen by detecting pressure. The pointing device itself does not move. The click buttons work like those on a standard mouse—what they do depends on the software you're using.

1. Place your hands in the typing position.
2. With your index finger, gently press the pointing device in the direction you want the pointer to move.
3. Click the buttons with your thumb to select and drag.

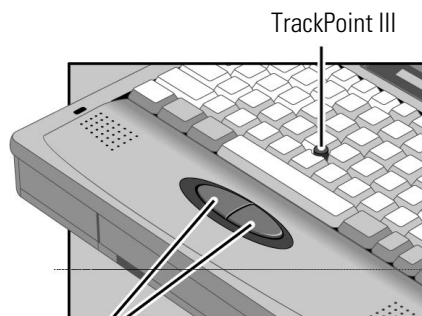

Click buttons

To adjust the OmniBook keyboard

You can tilt the OmniBook keyboard to a more comfortable typing angle with the built-in tilt feet located on the bottom of the OmniBook.

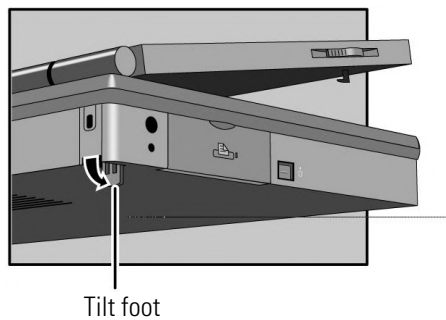

Special features of the OmniBook keyboard

In addition to the standard typing keys, the OmniBook keyboard contains the following special keys and features:

F_n combination keys

Use the gold F_n key in combination with other keys to execute special functions—for example, F_n+F8 decreases the speaker volume. You press *and hold* the F_n key, then you press the other key.

Embedded numeric keypad

Press the Num Lock (number lock) key to use the numeric keypad. With the keypad active, keys change to the designations shown on their slanted faces.

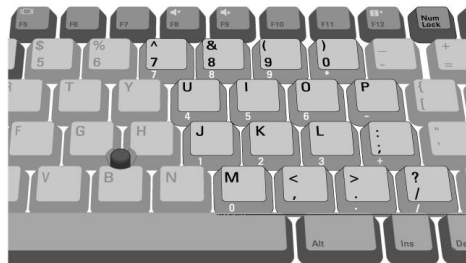

Alt Gr key

If your keyboard has an Alt Gr key to the right of the spacebar, you hold that key to type the characters printed at the bottom-right corners of keys. For keys that have four characters, hold SHIFT and Alt GR to type the upper-right characters.

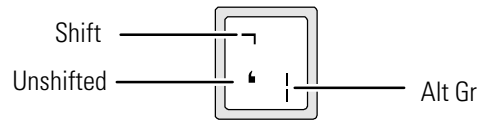

To adjust the speaker volume

All OmniBook 2000/5700 models support Sound Blaster compatible sound. The easiest way to adjust the speaker volume is to use the built in Fn key combinations.

- Hold down Fn and press F8 or F9 as needed to gradually decrease or increase the maximum volume.

To connect a microphone, speakers, or headphones

Your OmniBook has a built-in microphone above the keyboard and two stereo speakers. You can also plug in an external microphone, external speakers or headphones, and a stereo input source—such as a CD player.

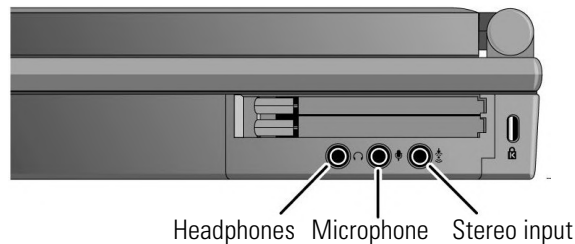

When you plug in an external microphone, the built-in microphone turns off. When you plug in stereo speakers or headphones, the built-in speakers turn off.

To start the OmniBook

You can easily start and stop your OmniBook using the blue On/Suspend button. However, at certain times, you may want to use other methods for starting and stopping your OmniBook—depending on power considerations, types of active connections, and startup time.

- Press the blue On/Suspend button. Either your previous session resumes or the computer reboots, depending on how you stopped the computer—see the next topic.

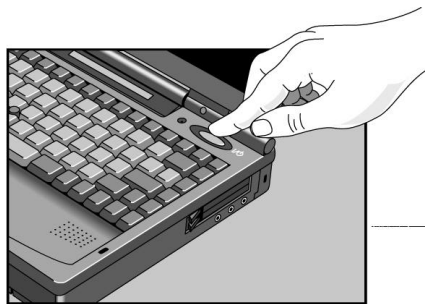

If you want to know more about what happens when you stop the OmniBook, you can check the table on page 1-14. It can help you decide what's best for the way you work.

To stop the OmniBook



Suspend icon appears
in the status panel.

- Press the blue On/Suspend button—this is the most convenient way if you're using Windows 95 or Windows for Workgroups. This maintains the current session and "turns off" the computer. The session resumes when you turn on the computer.

—or—

Press Fn+F12 simultaneously with the ac adapter unplugged. This stores the current session on the hard disk and completely shuts down the OmniBook. The computer reboots when you turn it on, then restores the session.

–or–

Shut down Windows, then press the square Off button on the left side of the case for 2 seconds. This deletes the current session and completely shuts down the OmniBook. The computer reboots when you turn it on and starts a new session.

CAUTION

Windows 95 can become unstable if you press the square Off button without properly shutting down Windows.

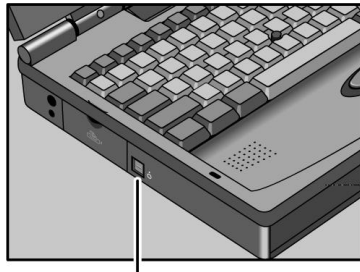

Off button

CAUTION

If you have active network connections, or if you have any SCSI devices connected, plug in the ac adapter and press the blue On/Suspend button to stop the OmniBook. These connections and devices are disconnected if you stop the OmniBook any other way.

Windows 95 can restore network connections and SCSI devices when you turn on the OmniBook. For a different operating system, you may have to reboot the OmniBook or restart the operating system to restore them.

Starting Out with Your OmniBook
 A tour of the OmniBook

Effects of Stopping the OmniBook

When you press this	The OmniBook does this	Limitations of this method are
On/Suspend button (with ac adapter)	Turns off the display. Continues the current session. Maintains network connections. Maintains SCSI devices. Charges the battery. Restarts quickly ("Instant-On").	Requires ac power. Saves minimal power.
On/Suspend button (no ac adapter)	Turns off the display. Maintains current session. Saves significant power. Restarts quickly ("Instant-On").	Loses network connections. * Loses SCSI devices. * Requires some battery power.
Fn+F12 button (no ac adapter)	Saves maximum power. Saves current session.	Reboots at startup. Loses network connections. * Loses SCSI devices. *
Off button	Saves maximum power. Resets everything at startup. Starts a new session. Charges battery if ac adapter is connected.	Reboots at startup. Loses current session. Loses network connections. * Loses SCSI devices.* Potential loss of data if not properly shut down.

Power States after Stopping the OmniBook

Method of Stopping	Power State	Condition
On/Suspend button (with ac adapter)	Display Off	Powered/operating state. The computer looks off, but only the display, keyboard, and pointer are turned off. Network and SCSI devices are maintained. Everything continues at turn-on.
On/Suspend button (no ac adapter)	Suspend	Low-power/stopped state. Everything is off or in a low-power state. Network and SCSI devices are off. Everything resumes operating at turn-on.
Fn+F12 button (no ac adapter)	Hibernate	No-power/stopped state. Everything is shut down. Computer reboots and restores previous session at turn-on.
Off button	Off	No-power/stopped state. Everything is shut down (battery charges if ac adapter is connected). Computer reboots at turn-on.

* Windows 95 can restore network connections and SCSI devices when you turn on the OmniBook.

For Windows 95, the Start button provides two commands that stop the OmniBook.

- Suspend changes the OmniBook to the Suspend state.
- Shut Down (shut down the computer) changes the OmniBook to the Off state.

If you plug in the ac adapter while the OmniBook is stopped, battery-charging components are activated, but the OmniBook stays in the same power state. On the other hand, if you unplug the ac adapter while the OmniBook is in the Display Off state, it changes to the Suspend state—if you plug it in again, the OmniBook stays in the Suspend state.

In addition, Advanced Power Management (APM) provides several automatic power-saving features that affect the power state. You can adjust settings in the System Configuration Utility to control features such as the following. See page 4-8 for more information about the SCU.

If the OmniBook is running on battery power and there's no activity for a short period of time, it automatically stops by changing to the Suspend state.

If you leave the OmniBook stopped in the Suspend state for a long time without plugging in the ac adapter, it automatically saves power by changing to the Hibernate state. Your session is saved.

To reset and restart the OmniBook

If your OmniBook stops responding—and you can't correct the problem in Windows—you can reset the OmniBook and restart Windows.

1. If possible, shut down Windows.
2. Press Ctrl+Alt+Del to reboot the OmniBook.

–or–

Press the square Off button on the left side of the case for 2 seconds, then press the blue On/Suspend button.

–or–

Insert a straightened paper clip into the small hole below the ac adapter socket and press the Reset button inside the hole.

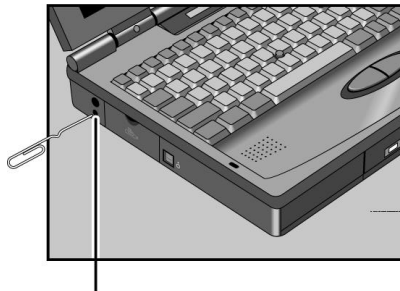

Reset button

Hint

If you want to reboot from a boot disk in the floppy disk drive, put the disk in the floppy disk drive before you restart the OmniBook. For example, you can reboot from the *Support Utility* disk, then use the commands on this disk to check your hard disk.

To understand the status panel

The OmniBook status panel, located above the keyboard, contains indicators that show the current status of the OmniBook. There are three groups of icons on the status panel that indicate

- Keyboard status.
- Data storage status.
- Power status.

Keyboard status

The icons on the right indicate Caps Lock, Num Lock, and Scroll Lock.



This icon appears when Caps Lock is active.



This icon appears when Num Lock is active.



This icon appears when Scroll Lock is active.

Data storage status

The center icons indicate data storage areas—CD-ROM activity, floppy disk activity, hard disk activity, and PC card status.



This icon appears when the OmniBook is reading from the built-in CD-ROM drive.



This icon appears when the OmniBook is reading or writing to the floppy disk drive.



This icon appears when the OmniBook is reading or writing to drive C.



These icons appears when you insert PC cards into the card slots. Each icon identifies when a PCMCIA card slot is occupied.

Starting Out with Your OmniBook
A tour of the OmniBook

Power status

These icons indicate power conditions—ac adapter use, battery status, charging status.



This icon appears when the OmniBook is in the Suspend power state; the “bookmark” icon reminds you that the state of the computer has been saved.



This icon appears when the ac adapter is plugged in.



The shading of the battery symbol shows the approximate charge level of the battery relative to a full charge.



The lightning bolt symbol appears when the battery is charging. The battery symbol blinks when the battery is low.

To attach a security cable

1. Wrap the cable around a stationary object, such as a table leg.
2. Loop the cable to create a slip knot around the stationary object—make sure it can't slip off.
3. Insert the lock into the OmniBook's Kensington lock slot and release the key.
Store the key in a safe place away from the OmniBook.

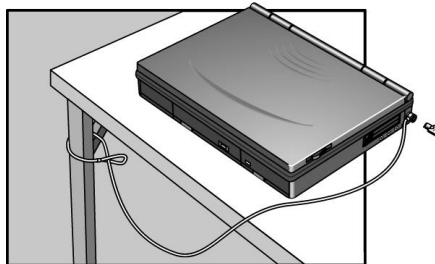

Using OmniBook Accessories

Depending on the accessories you purchased with your OmniBook, the center drive-bay can hold an internal CD-ROM drive, a floppy disk drive, or a high-capacity battery.

In this section you'll learn how to

- ◆ Remove accessory modules from the OmniBook.
- ◆ Install and use the floppy disk drive.
- ◆ Install and use the CD-ROM drive.
- ◆ Replace the main battery.
- ◆ Install a second, high-capacity battery.
- ◆ Handle and store the battery safely.
- ◆ Maintain and preserve battery life.
- ◆ Insert and remove a PC card.

To remove accessories from the OmniBook

The OmniBook's center drive bay can hold a CD-ROM drive, a floppy disk drive, or a high-capacity (2nd) battery for extra power.

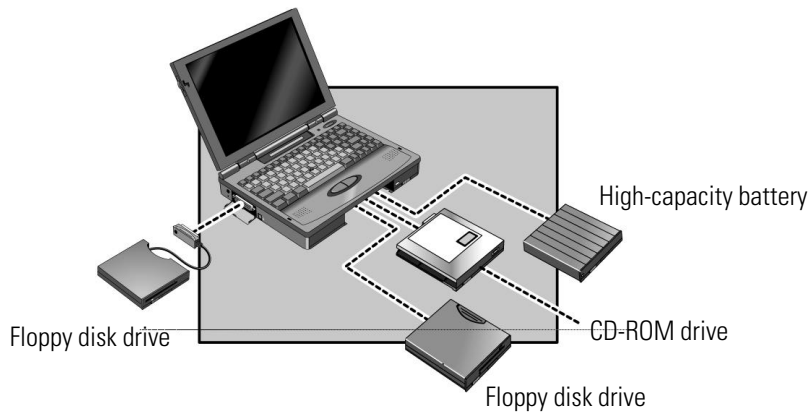

Use this procedure to remove any of these accessories.

1. Slide the switch to the right. A pull-tab pops out.
2. Pull the pull-tab firmly to remove the module from the OmniBook.

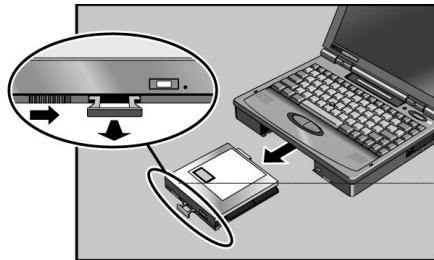

CAUTION

To prevent damage to the pull -tab, gently push the tab back into the module after you remove it from the OmniBook.

To install the floppy disk drive

1. If necessary, remove the current accessory module from the OmniBook.
2. Slide the floppy disk drive into the OmniBook until it clicks into place.

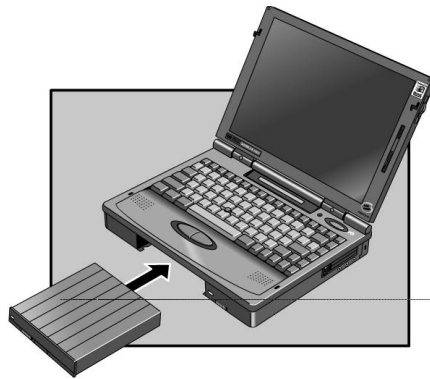

–or–

Connect the floppy disk drive to the OmniBook externally by pulling out the floppy disk drive cable and connecting it to the parallel port on the left side of the OmniBook.

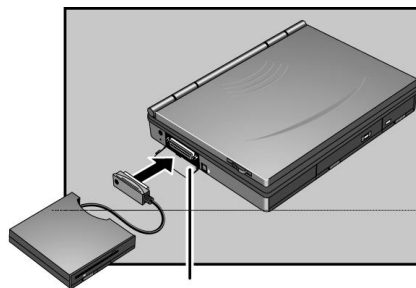

Parallel port

Important

The external floppy disk drive works only with the OmniBook's parallel port. It does not work with the parallel port on the docking system or port replicator.

To insert and eject a floppy disk



floppy disk indicator

CAUTION

When the OmniBook is reading or writing data to the floppy disk drive, the floppy disk indicator appears on the Status Panel (above the function keys).

Do not insert or remove a floppy disk while the OmniBook is actively reading or writing data. Wait until the floppy disk drive stops reading or writing. Otherwise, you could lose data or the OmniBook could stop responding.

1. Hold the disk with its face up, then slide it into the floppy disk drive slot until it clicks into place.

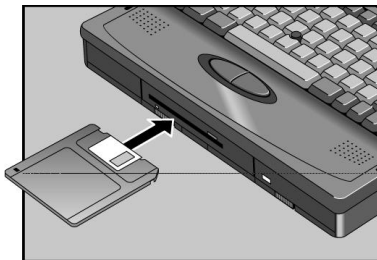

2. To remove the floppy disk, press the eject button on the front of the floppy disk drive.

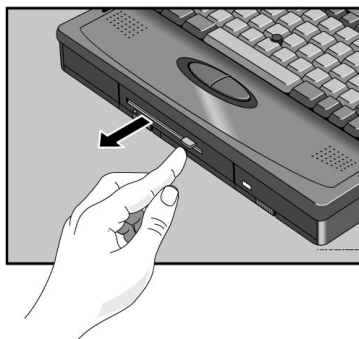

To install the CD-ROM drive

You install the CD-ROM drive in the center drive bay of the OmniBook. To use both the CD-ROM drive and the floppy disk drive, connect the floppy disk drive to the OmniBook's parallel port (on the left side of the OmniBook).

1. Important

Save your work and shut down Windows—you'll be restarting the OmniBook.

2. If necessary, remove the current accessory module from the OmniBook.
3. Slide the CD-ROM drive into the OmniBook until it clicks into place.

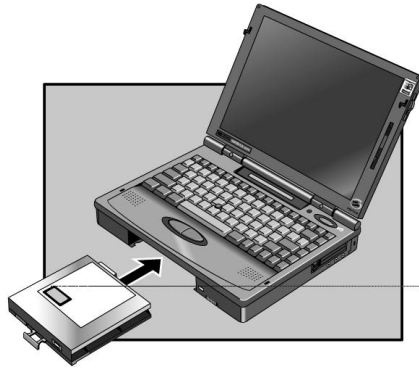

4. Press the square Off button for 2 seconds, then press the blue On/Suspend button to restart the OmniBook.

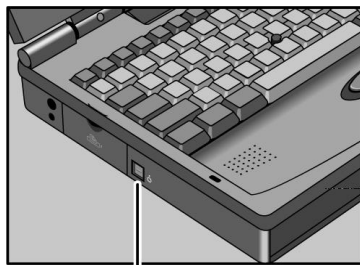

Off button

To insert and remove a CD



CD disk indicator

When the OmniBook is reading data from the CD-ROM drive, the CD disk indicator appears on the Status Panel (above the function keys).

CAUTION

Do not insert or remove a CD while the OmniBook is actively reading data. Wait until the CD-ROM stops reading. Otherwise, the OmniBook could stop responding and you could lose data.

1. Press the open button on the front of the CD-ROM drive.

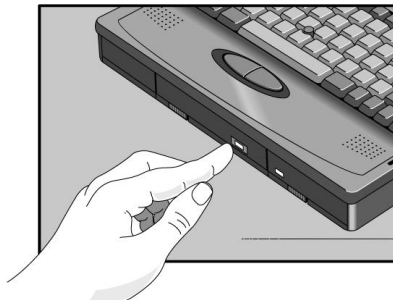

2. Place the CD in the drive and gently press down to seat it on the spindle.
Do not touch the CD-ROM drive lens, located on the surface of the drive.

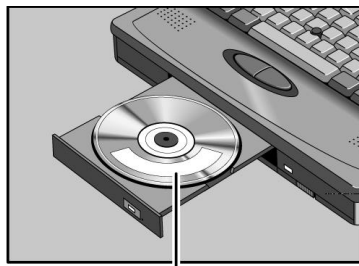

Label up

3. Close the door to the drive.
4. To remove the CD, press the open button on the front of the CD-ROM drive.

To use the CD-ROM drive safely

The CD-ROM drive used with the OmniBook is certified as a Class 1 laser device according to the U.S. Department of Health and Human Services (DHHS) Radiation Performance Standard and International Standards IEC 825 / IEC 825-1 (EN60825 / EN60825-1). This device is not considered harmful, but the following precautions are recommended:

- Ensure proper use by reading and following the instructions carefully.
- If the unit requires service, contact an authorized HP service center—see the OmniBook *Support and Service* booklet.
- Do not attempt to make any adjustment of the unit.
- Avoid direct exposure to the laser beam—do not open the unit.

CLASS 1 LASER PRODUCT
LASER KLASSE 1

To replace the battery



Fully charged battery

The primary source of power for the OmniBook is its rechargeable battery. The OmniBook provides several safeguards so that you won't be surprised by a dead-battery condition—the status panel shows the remaining battery charge, the battery symbol blinks when the battery is low, and a lightning bolt symbol appears on the status panel when the battery is charging.

To preserve your current work session, the OmniBook automatically turns off when the battery charge gets too low—your session continues when you plug in the ac adapter or insert a fresh battery.

1. Important

Save your work. Then press the blue On/Suspend button to stop the OmniBook.

2. If available, plug in the OmniBook's ac adapter.

3. Slide the battery switch to the right and slide the battery out of its compartment.

Slide switch to
release battery.

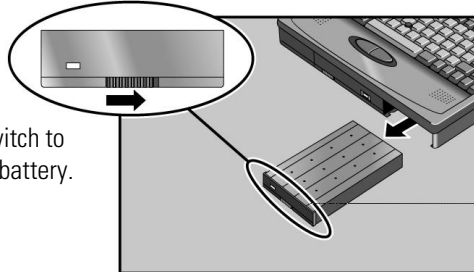

4. Slide the new battery all the way into the battery compartment.

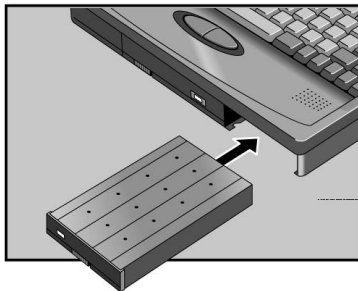

To install a high-capacity battery

To increase the time you can work on battery power, you can install a second, high-capacity battery in the OmniBook's center drive bay.

1. Important

Save your work. Then press the blue On/Suspend button to stop the OmniBook.

2. If necessary, remove the current accessory module from the OmniBook.

3. Slide the high-capacity battery into the OmniBook, then gently press the latch forward until it clicks into place.

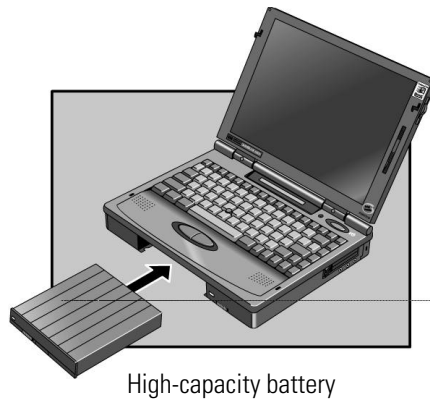

A second Battery Status icon appears in the LCD status panel, showing the approximate charge level of the new battery.

To handle and store the battery safely

To safely use the battery, follow these instructions:

- To avoid risk of fire, burns, or damage to your battery pack, do not allow a metal object to touch across the battery contacts.
- The battery pack is suitable for use only with compatible OmniBook models and specified battery charger. Check the *Support and Service* booklet for your local HP contact.
- Do not disassemble. There are no serviceable parts inside. Do not dispose of the battery pack in fire or water.
- Handle a damaged or leaking lithium-ion battery with extreme care. If you come in contact with the electrolyte, wash the exposed area with soap and water. If it contacts the eye, flush the eye with water for 15 minutes and seek medical attention.
- Do not expose the battery pack to high storage temperatures (above 60 °C, 140 °F).
- When the battery is not in use, store it in the battery pouch provided.
- When discarding a battery pack, contact your local waste disposal provider regarding local restrictions on the disposal or recycling of batteries.
- To obtain a replacement battery, contact your local dealer or HP sales office.
- Do not charge the battery pack if the ambient temperature exceeds 45 °C (113 °F).

To maintain and preserve battery life



Protect battery life

To preserve the life of your battery, be sure to charge the battery pack regularly. If a battery pack is not used, it has limited shelf-life. Following a full (100%) recharge, a battery pack has the following shelf-life:

Small pack

Without recharging, it fully discharges in 1 year, and is unusable in 2 years.

Large pack

Without recharging, it fully discharges in 1.5 years, and is unusable in 3 years.

To insert a PC card

The OmniBook PC card slots are available for storing data and expanding the communication capabilities of the OmniBook. The OmniBook supports standard Type I, II, and III PC cards (PCMCIA and CardBus). You can use two thin cards or one thick card. The lower card slot supports Zoomed Video, which allows a zoomed video card to show high-quality multimedia presentations.

CAUTION

Do not install Card Services or Socket Services software if it comes with your PC card. The OmniBook already includes Card Services and Socket Services, which automatically detect and set up PC cards you install in the upper and lower card slots. Different versions of this software will disrupt this support. Never insert or remove a plug-in card while an OmniBook PC card drive is actively reading or writing data. Wait until the PC card drive stops reading or writing. Otherwise, you could lose data or the OmniBook could stop responding.

The OmniBook automatically detects and sets up a card when you insert it in a card slot. See the card's instructions for additional information.

1. Hold the card with its face up and its connector holes toward the card slot, then slide it into a PC card slot until it won't go any further.
2. When the card is fully inserted, the PC card indicator appears on the Status Panel. A double beep signals that the card has been recognized and is
3. Inserting a card causes the slot's button to protrude from the case. You can rotate the button towards the front to make it flush with the case.



PC card indicator

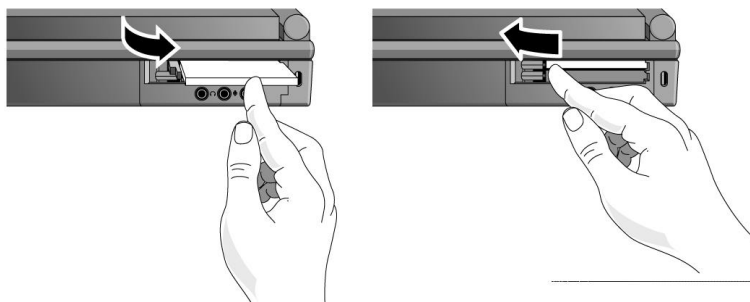

About RAM Cards

If you're using a RAM card with the OmniBook, keep these suggestions in mind:

- For a new RAM card, install its battery before you insert the card.
- Replace the RAM card battery yearly.

When you want to replace a RAM card battery, plug the card into the OmniBook and make sure the OmniBook stays turned on while you replace the battery. You can plug in the ac adapter to keep it from turning off. Otherwise, the data on the card will be lost.

To remove a PC card

CAUTION

Never remove an I/O card while an application is open that's set up to use that card. Exit the application first. If you remove the card, the application (or the OmniBook) might behave unpredictably or stop responding until you restart the OmniBook. Never insert or remove a plug-in card while the PC card drive is actively reading or writing data. Wait until the PC card drive is done. Otherwise, you could lose data or the OmniBook could stop responding.

1. If you're using Windows 95

Click the PC card indicator in the taskbar, then click Stop. This protects your data and avoids unexpected problems. You can restart the card by removing it, then inserting again.

If you're using Windows for Workgroups

Go to step 2.

2. If necessary, rotate the ejector button so that it protrudes from the case.

3. Press the black ejector button until the card pops out, then pull out the card.

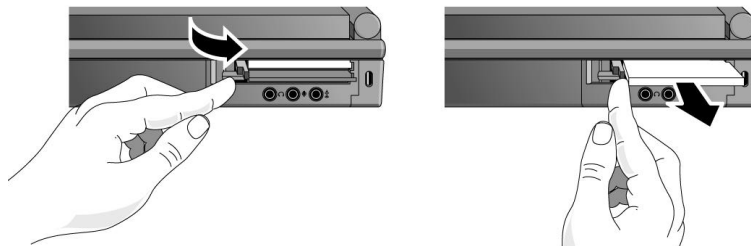

Where to Go from Here

You can probably start using your OmniBook immediately, especially if you're familiar with personal computers, or if you've already worked with Microsoft Windows. Still, your OmniBook is designed as a compact, mobile computer—so it has a few useful features that you don't normally find on a desktop PC. Take a few minutes to explore them.

See the Online Documentation

For detailed information about the OmniBook, see the online *User's Guide*. Also see the other online information in the online OmniBook Library.

Check OmniBook Notes

For late-breaking information available after the manuals were completed, see OmniBook Notes in the online OmniBook Library.

Visit Our Web site

For updates to the BIOS and other technical information, connect to our World-Wide Web site on the Internet at <http://www.hp.com/go/omnibook>.

See the *Corporate Evaluator's Guide* at our Website for complete information about installing alternate operating systems, as well as how to configure the OmniBook in a corporate, networked environment.

Installing an Operating System

Installing an Operating System

This chapter has instructions for installing or recovering an operating system. Your OmniBook package includes a *Recovery CD*, the (FAT16) *Support Utility* floppy disk, and the *Microsoft Windows 95 Companion CD*. With these tools, you can install or recover

- ◆ Windows 95 operating system.
- ◆ Windows for Workgroups from your own disks.
- ◆ Other HP programs, online *User's Guide*, and drivers from the *Recovery CD* that came with your OmniBook.
- ◆ Windows NT and OS/2 Warp from your own disks, and using instructions and drivers from the *Corporate Evaluator's Guide* on our Website at <http://www.hp.com/go/omnibook>. In addition, this site contains the latest updates of software drivers, and information on configuring the OmniBook in a corporate, networked environment.

You can also create a FAT32 (*file allocation table, 32-bit*) hard-disk configuration using either the *Recovery CD* or a separate product, such as PartitionMagic by PowerQuest. Using the *Recovery CD* to create a FAT32 hard-disk configuration necessitates *erasing the hard drive* and making a floppy boot disk.

Note

As part of your initial setup of the computer, you have one opportunity to select one of the factory-installed operating systems. See chapter 1.

What the Recovery CD Contains

You will need the *Recovery* CD-ROM and the *Support Utilities* floppy disk to recover the Windows 95 operating system or HP factory-installed software.

Directory	Contains...
README.TXT text file	Instructions for using the <i>Recovery</i> CD.
RECOVER\	
ENC	Encrypted Microsoft Windows 95 recovery files. (Usable only in conjunction with the <i>Support Utilities</i> disk.)
BOOTDISK	For creating your own copy of a boot disk (like the <i>Support Utilities</i> disk or the FAT32 <i>Support Utility</i> disk).
FILE.CHK and FILE32.CHK	Checksum program. Checksum program for FAT32.
README text file	Same as README.TXT
OMNIBOOK\	
HPADDON.WFW	For Windows for Workgroups: Use this for the easiest setup after installing Windows for Workgroups, but before installing applications and user files. Overlays a standard MD-DOS 6.22 and Windows for Workgroups system with necessary drivers and optional OmniBook. This results in a system similar to the Windows for Workgroups system shipped with the OmniBook.
HPUTILS	For Windows for Workgroups and Windows 95: Use this to pick and install optional HP OmniBook applications, including Appointment Book, Phone Book, Calculator, the online <i>User's Guide</i> , Tools, Diagnostics.
DRIVERS	Use this to manually install individual audio, video, SCSI, and PC-Card (PCMCIA) drivers for various operating systems (MS-DOS, OS/2, Windows of all types). Look for the specific driver for the specific version of your operating system. Each driver has a README file with instructions.
MANUALS	User's guides under \W95 and \WFW. Use this for direct viewing of the guide from the CD, not for its installation.
WFW_DRV	Installs and updates Windows for Workgroups drivers, even on systems that contain existing applications and user files.

The following sections tell you how to set up and start a recovery installation. Refer to the README text file on the *Recovery* CD and the *Support Utilities* disk for step-by-step instructions.

Reinstalling Windows 95

The following procedure describes how to reinstall the Windows 95 operating system that came with your OmniBook. These steps will format the hard drive. Back up any files you would like to save before reinstalling *Windows 95*.

The entire recovery process takes approximately 1 hour. To recover your Windows 95 operating system, you'll need a CD-ROM drive, floppy disk drive, the *Recovery CD*, and the *Support Utility* disk.

To reinstall Windows 95

1. If you have an internal CD-ROM drive, connect the floppy disk drive to the OmniBook's parallel port and install the CD-ROM drive in the OmniBook.

–or–

If you have a SCSI CD-ROM drive and a docking system, connect the SCSI CD-ROM drive to the docking system and install the floppy disk drive in the OmniBook.

–or–

If you have a PC card or Parallel Port CD-ROM drive, connect the PC card or Parallel CD-ROM drive and install the floppy disk drive in the OmniBook. See "To set up a PC card or parallel port CD-ROM drive" on page 3-15.

2. Connect the ac adapter to the OmniBook.
3. Insert the *Recovery CD* in the CD-ROM drive.
4. Insert the *Support Utility* disk in the floppy disk drive.
5. Reset the OmniBook.

The DOS 6.22 Startup menu appears.

6. Click option 2:

Recover Windows 95 from OmniBook Recovery CD

7. Click the type of CD-ROM drive you're using—internal OmniBook, SCSI with docking system, or PC card or parallel port.
8. Follow the setup instructions on the screen.

9. When prompted for “Hibernate” partition size, you can continue with the default 64M byte Hibernate partition or choose an alternate size (based on the amount of system RAM installed).
10. After the successful creation of the Hibernate partition , press Ctrl+Alt+Del to reboot the OmniBook.
The DOS 6.22 Startup menu appears.
11. Click option 2:
Recover Windows 95 from OmniBook Recovery CD
12. Click the type of CD-ROM drive you’re using—internal OmniBook, SCSI with docking system, or PC card or parallel port.
The recovery process continues. This can take up to an hour. Do not interrupt the recovery process or unplug the ac adapter until recovery is completed.

Reinstalling Windows for Workgroups

The following procedure describes how to restore Windows for Workgroups and your original OmniBook software.

The entire recovery process takes approximately 1 hour. To recover your Windows for Workgroups operating system, you'll need a CD-ROM drive, floppy disk drive, your Windows for Workgroups backup disks, your MS-DOS 6.22 backup disks, the *Recovery CD*, and the *Support Utility* disk. If you don't have backup disks, you can make them—see “To make DOS 6.22 and Windows for Workgroups disks.”

To reinstall Windows for Workgroups

1. If you have an internal CD-ROM drive, connect the floppy disk drive to the OmniBook's parallel port and install the CD-ROM drive in the OmniBook.

–or–

If you have a SCSI CD-ROM drive and a docking system, connect the SCSI CD-ROM drive to the docking system and install the floppy disk drive in the OmniBook.

–or–

If you have a PC card or parallel port CD-ROM drive, connect the PC card or Parallel CD-ROM drive and install the floppy disk drive in the OmniBook. See “To set up a PC card or parallel port CD-ROM drive” on page 3-15.

2. Connect the ac adapter to the OmniBook.
3. Insert the *Support Utility* floppy disk.
4. Reset the OmniBook.

The DOS 6.22 Startup menu appears.

5. Click option 4:

Create Hibernate Partition (erases Hard Disk)

6. When prompted for “Hibernate” partition size, you can continue with the default 64M byte Hibernate partition or choose an alternate size based on the amount of system RAM installed.

7. After the successful creation of the Hibernate partition, insert MS-DOS Disk #1 into the floppy disk drive, then press Ctrl+Alt+Del to reboot the OmniBook.
8. Follow the setup instructions on the screen.
9. When prompted for installation choices, click the defaults.
10. When the MS-DOS installation is complete, insert MS-DOS Disk #4 and type A:. This is the MS-DOS Supplemental disk.
11. Type `SETUP C:\DOS` to install the MS-DOS supplemental files.
12. Install Windows for Workgroups (from back-up installation disks or from purchased software) to drive C as follows:
 - Insert disk #1 and type `A:\SETUP`.
 - Click Express Setup.
 - Select all defaults for this installation. *Do not install any printers or networks.* Install them after the rest of this installation is complete.
13. Insert the *Recovery CD* in the CD-ROM drive.
14. Insert the *Support Utility* disk in the floppy disk drive.
15. Reset the OmniBook. The DOS 6.22 Startup menu appears.
16. Click option 3:
Recover Windows for Workgroups drivers and HP Application Software
17. Click the type of CD-ROM drive you're using: internal OmniBook, SCSI with docking system, or PC card or parallel port.
Do not interrupt the recovery process or unplug the ac adapter until recovery is completed.

To make DOS 6.22 and Windows for Workgroups disks

When you set up the Windows for Workgroups operating system, you should have been prompted to create a set of backup disks for Windows for Workgroups and DOS 6.22. If you did not make backup disks, you can do so now with the following procedure.

1. From the OmniBook group, double-click Make Backup Installation Disks.
2. Follow the setup instructions on the screen.

To install Windows for Workgroups drivers

If you've installed a commercial version of Windows or Windows for Workgroups, you'll need to manually install the required OmniBook device drivers or use the OmniBook 2000/5700 Windows 3.X Driver Setup program. These steps modify some of your system files—such as WIN.INI and AUTOEXEC.BAT. An original version of each file is preserved in the C:\OMNI_DRV.XXX directory.

1. If you have an internal CD-ROM drive, connect the floppy disk drive to the OmniBook's parallel port and install the CD-ROM drive in the OmniBook.

—or—

If you have a SCSI CD-ROM drive and a docking system, connect the SCSI CD-ROM drive to the docking system and install the floppy disk drive in the OmniBook.

—or—

If you have a PC card or parallel port CD-ROM drive, connect the PC card or Parallel CD-ROM drive and install the floppy disk drive in the OmniBook. See “To set up a PC card or parallel port CD-ROM drive” on page 3-15.

2. Connect the ac adapter to the OmniBook.
3. Insert the *Support Utility* floppy disk.
4. Reset the OmniBook. The DOS 6.22 Startup menu appears.
5. Click option 5:
Exit to MS-DOS
6. Insert the *Recovery CD* in the CD-ROM drive.
7. From the DOS prompt, type C:\WINDOWS\WIN to start Windows.

Note

The path may need to be adjusted if Windows was installed in a location other than the default.

8. From File Manager, go to the CD-ROM drive.
9. Double-click setup.exe in the \omnibook\wfw_drv\disk1 directory.
The OmniBook 2000/5700 Windows 3.x Drivers setup menu appears.
10. Choose Next to install the drivers, then follow the setup instructions.

Installing Windows NT or OS/2 Warp

You provide the software to install these alternate operating systems. See the *Corporate Evaluator's Guide* at our Website for complete information on installing these operating systems, as well as how to configure the OmniBook in a corporate, networked environment.

To install Windows NT or OS/2 Warp

You will need OmniBook-specific drivers. The drivers for alternate operating systems are located

- On the *Recovery* CD ROM, under OMNIBOOK\DRIVERS.
- On the OmniBook's hard drive under C:\OMNIBOOK\DRIVERS.
- On our Website at <http://www.hp.com/go/omnibook> . This site contains the latest updates of software drivers.

Different versions of an operating system require different drivers, so make sure to select the appropriate driver

The equipment you need are the OmniBook, its ac adapter, a floppy disk drive, and a CD-ROM drive (preferably SCSI-type). You also need the *Support Utility* floppy disk. If you have a docking system, you can leave the OmniBook docked during most of this procedure.

CAUTION

Before you start installing a new operating system, make sure the drivers you need will be accessible after the installation . Copy them from the web site or the hard drive to a floppy disk, or use the *Recovery* CD with a CD-ROM drive.

Installing HP Applications

If you have deleted the online *User's Guide*, OmniBook Tools, or any of the Personal Information Management applications, you can reinstall them from the Recovery CD.

To install HP software programs

1. If you have an internal CD -ROM drive , install it in the OmniBook.
-or-
If you have a SCSI CD -ROM drive and a docking system , connect the SCSI CD-ROM drive to the docking system.
-or-
If you have a PC card or parallel port CD -ROM drive , connect the PC card or parallel port CD-ROM drive. See "To set up a PC card or parallel port CD-ROM drive" on page 3-15.
2. Insert the *Recovery CD* in the CD-ROM drive.
From the \OMNIBOOK\HPUTILS\DISK1 directory on the CD, double-click SETUP.EXE. The OmniBook Application Software Setup menu appears.
3. Click the HP applications you'd like to install, then click Install Now.

Expanding the OmniBook

Expanding the OmniBook

This chapter describes procedures to expand or update the capabilities of your OmniBook, including:

- ◆ Replacing internal hardware.
- ◆ Connecting external devices.



Replacing Hardware

This section describes how to

- ◆ Remove and install the hard disk drive.
- ◆ Find the system software version and memory size.
- ◆ Install a memory-expansion board.

To remove the hard disk drive

You can upgrade the OmniBook system by installing a new hard drive or you may want to switch hard drives between OmniBooks.

1. Important

Back up all the files on your current drive C. You can back up the files to a tape drive, a network drive, a PC card, or a flexible disk.

2. Unplug the adapter.

3. Exit Windows.

- If you're using Windows 95, use the shutdown option from the Start menu.
- If you're using Windows for Workgroups, exit Windows, then press the Off button.

4. Remove all batteries from the OmniBook.

5. Close the cover and turn your computer over.

6. Remove the screw and security cover located at the back of the hard disk drive.

7. Firmly slide the drive out of the drive compartment. (This requires some force.)

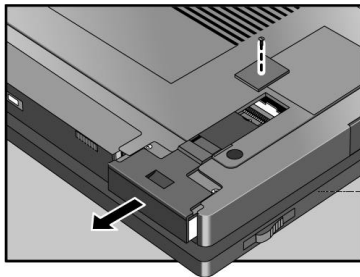

To install the hard disk drive

After following the previous instructions for removing the hard disk drive, use these steps to install the new hard drive.

1. Gently press downwards on the hard drive while you slide it into the drive bay.
2. Make sure the drive is fully inserted.

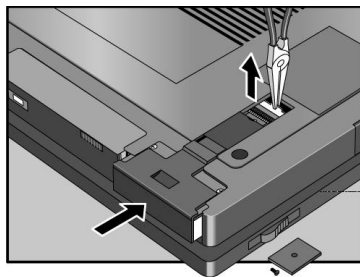

It may be necessary to use a small pair of pliers to pull up on the PC-board tab. While pulling up on the tab, gently press downwards on the hard drive while you slide it into the drive bay.

3. Replace the screw and security cover.
4. Replace the battery or attach ac power.
5. Press the Off button for 2 seconds, then press the blue On/Suspend button.

To find the system software version and memory size

In Windows 95

- Click Start, HP User Tools, Information 2, OmniBook System Information. The software version and amount of memory are displayed.

In Windows for Workgroups

1. In Program Manager, double-click the OmniBook Tools icon (in the Main group).
2. In the window's Control menu, click About. The software version and amount of memory are displayed.

To add memory to the OmniBook

The OmniBook memory slots accommodate two memory-expansion boards. You can install a memory-expansion board to increase the total amount of memory.

CAUTION

Take precautions against damage from static electricity: Gather all the parts you need so you can complete the installation in one sitting. Don't remove the memory-expansion board from its packaging until you've removed the slot cover from the OmniBook. Do not use an ac adapter from another product. When you remove the board from its packaging, hold it only by its edges. Don't touch the electronic components or gold traces. Also, turn off the unit, unplug the ac adapter, and remove the battery. Otherwise, the OmniBook or memory-expansion board may be damaged.

1. Exit Windows—your current session and any data not saved will be lost.
 - If you're using Windows 95, use the shutdown option from the Start menu.
 - If you're using Windows for Workgroups, exit Windows, then press the square Off button.
2. Unplug the adapter and remove all batteries from the OmniBook.
3. Use a flat-blade screwdriver to remove the cover from the expansion slot.
4. If a memory-expansion board is already present in both slots, pull out the board you want to replace. Use the tape tab to loosen the card from its connectors, then lift.
5. Position the memory-expansion board over the connectors and press in the board until it seats fully. Be careful not to press in the center of the board as this could crack it. Press the board above the connectors.
6. Replace the slot cover.
7. Insert the battery, then press the blue On/Suspend button.
8. When you see the following message:
WARNING - UNEXPECTED AMOUNT OF MEMORY - RUN SCU
press F2 to go to the System Configuration Utility.
9. Press Alt+X to open the SCU Exit menu.
10. Click Save and Exit to update the system configuration.



Expanding the OmniBook
Replacing Hardware

If you're using Windows for Workgroups

11. In Control Panel, double-click the Enhanced icon, then click Virtual Memory and Change.
12. If the Use 32-Bit File Access option is set, clear it, then set this option again. This updates the Cache Size setting.
13. Click OK to save the new setting. When prompted, click Restart Windows to activate the new setting.



Connecting Devices

Your OmniBook is a powerful computer in its own right—but you'll greatly expand its capabilities by connecting other devices. In this section you'll learn how to

- ◆ Connect an external monitor and adjust the display type.
- ◆ Turn off the built-in display.
- ◆ Connect and install a printer.
- ◆ Connect an external mouse and keyboard.
- ◆ Enable Fn keys on an external keyboard.
- ◆ Connect a serial device.
- ◆ View or change serial port assignments.
- ◆ Connect a parallel device.
- ◆ View or change parallel port assignments.
- ◆ Make an infrared connection and print on an infrared printer.
- ◆ Set up a PC card or parallel port CD-ROM drive.
- ◆ Connect a MIDI device or joystick.

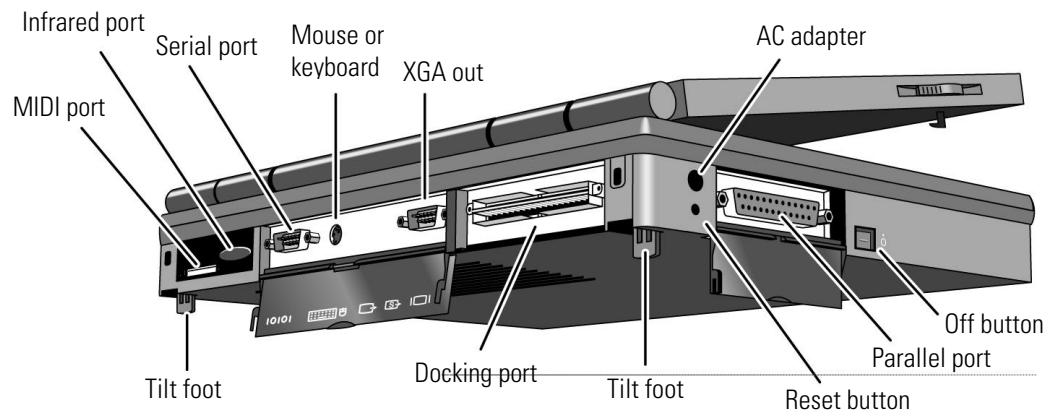

To connect an external monitor

You can connect a VGA, SVGA, or XGA monitor to your OmniBook. When you connect the external display, the OmniBook automatically recognizes and activates it. The built-in display turns off to conserve power.

1. Make sure the external monitor supports VGA, super VGA, or XGA format.
2. Plug the cable from the external display into the XGA-out connector at the back of the OmniBook.

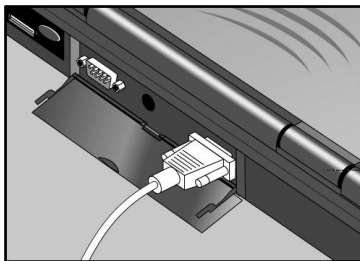

To adjust the display type

The default display setting provides optimum performance for the OmniBook's internal display. To change the display options for the external monitor

- in Windows 95—select Start, HP User Tools, Setup, Display, Settings.
- in Windows for Workgroups—double-click the OmniBook Tools, Display.

If the external display has higher resolution than the OmniBook display, you'll have to turn off the OmniBook display to see the higher resolution.

To turn off the built-in display

- Press Fn+F5 to switch between the external and built-in display.

To connect a printer

- Plug the printer cable into the appropriate port at the back of the OmniBook.
 - A parallel printer is normally at the LPT1 port.
 - A serial printer is normally at the COM1 port.

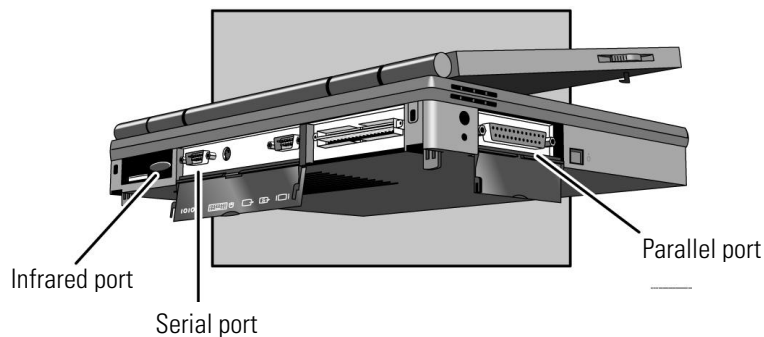

To install a printer

Before you can print from your OmniBook, you have to install the printer so that it can communicate with the OmniBook.

- In Windows 95—select Start, HP User Tools, Setup, Printers.
- In Windows for Workgroups—double-click Control Panel, Printers.

To connect an external mouse or keyboard

Although the OmniBook comes with a full-sized keyboard, you can attach an external keyboard and an external mouse.

1. Plug the mouse or keyboard cable into the external mouse/keyboard port on the back of the OmniBook.

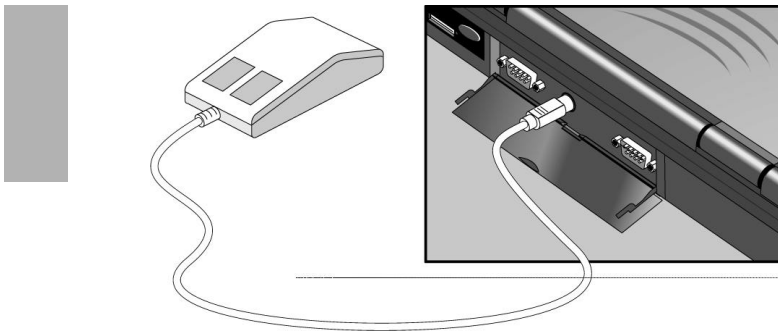

If you attach an external mouse, you cannot use the built-in TrackPoint III pointing device.

2. Turn the OmniBook off and on again with the blue On/Suspend button.

To connect both a mouse and keyboard

1. Purchase a standard Y-adapter available at computer dealers.
2. Plug the Y-adapter into the external mouse/keyboard port.
3. Connect the external mouse and keyboard to the Y-adapter.

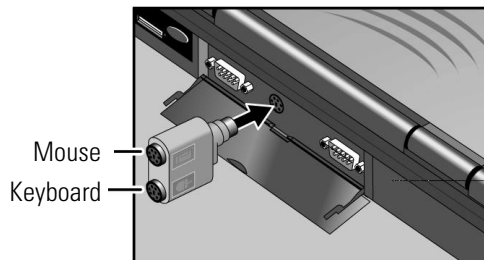

To enable the Fn keys

If you've connected an external keyboard, you need to enable the external Fn keys.

1. Press Fn+F2 to start the SCU.
2. From the Input/Output menu, select External Devices.
3. Check Enable External Fn Key.

To access the Fn key on your external keyboard, use Ctrl+Alt. For example, to access Fn+F2, press Ctrl+Alt+F2.

To connect a serial device

The OmniBook 9-pin serial port is a standard serial port, just like those found on many PCs. The most common types of serial connections involve printers, modems, and other computers. You can make such connections using standard serial cables and adapters available at computer dealers and electronic supply stores.

To view or change serial port assignments

You can see and change the serial communications port names (COM1, COM2, COM3, and COM4) assigned to the serial port and infrared port.

1. Save any open files—you may need to reboot your OmniBook.
2. Press Fn+F2 to enter the System Configuration utility.
3. Use the Input/Output menu COM Ports command to change the COM names for the serial port and the physical infrared port (normally COM1 and COM2). PCMCIA serial-type cards use the remaining COM names.
4. Exit the utility without rebooting—then click Start and Shut Down to restart the OmniBook. You must restart to make the new assignments active.
5. If you changed the port assignments, you must reboot the OmniBook to make the new assignments active.

To specify serial port settings

Many applications provide a way for you to adjust the settings for serial ports they use. Other applications don't let you change serial port settings. However, you can use Control Panel to set the basic serial port settings—the ones used by an application that doesn't change settings.

In Windows 95

1. From Control Panel, double-click System.
2. Click the Device Manager tab to see a list of serial (COM) ports.
3. To view the settings for a COM port, select the port and click Properties. (The serial port is normally COM1, and the physical infrared port is normally COM2.)

In Windows for Workgroups

- Open Control Panel and double-click the Ports icon. Click the port you want to set up, then set its parameters. For details, see the *Windows Quick Start* manual.

Hardware Settings

The changes you make to the *advanced* settings for a serial port should match your hardware settings. The built-in advanced settings are listed below—you shouldn't use different settings in any applications.

- COM1: address 3F8 hex, interrupt 4.
- COM2: address 2F8 hex, interrupt 3.
- COM3: address 3E8 hex, interrupt 4.
- COM4: address 2E8 hex, interrupt 3.

To connect a parallel device

The OmniBook 25-pin parallel port is a standard parallel port. The most common types of parallel connections involve connections to printers and to other computers.

- For a printer connection, use a standard parallel printer cable available at computer dealers or electronic supply stores.
- For any other connection, such as a bi-directional connection, use a special parallel cable designed for that purpose. See the manual for the software you're using.

To view or change parallel port assignments

You can see and change the parallel port names (LPT1, LPT2, LPT3) assigned to the printer port.

1. Save any open files—you may need to reboot your OmniBook.
2. Press Fn+F2 to enter the System Configuration utility.
3. From the Input/Output menu, click LPT Port.
4. Select the new port assignment and click OK.
5. From the Exit menu, click Save and Reboot.
If you're prompted, enter your password, then click OK.
6. Click OK to reboot your OmniBook.

The parallel addresses are as follows:

- LPT1: address 378 hex.
- LPT2: address 278 hex.
- LPT3: address 3BC hex.

To make an infrared connection

The infrared port provides a type of serial connection that doesn't require cables—you just have to line up the device's infrared port with the right rear of your OmniBook.

Keep the distance within about 3 feet (1 meter) for optimum performance. For example, you can establish a connection to an infrared printer by simply aiming the back of the OmniBook at the printer.

To print on an infrared printer

To connect to an infrared (IrDA-compatible) printer, set the OmniBook printer port to be the infrared printer port, LPT3. The Infrared Monitor provides visual status for infrared communications and helps you resolve infrared communication problems.

In Windows 95

- Click Start, Infrared. Use the tabs in the infrared window to set options. You can disable infrared printing by unchecking the Enable infrared communication box in the Options tab.

In Windows for Workgroups

1. From Program Manager, double-click OmniBook Tools (in the Main group).
2. Click Connections, then Infrared Communications.
3. Select the options you want:
 - You can enable infrared printing immediately.
 - You can enable infrared printing every time you start Windows.
 - You can disable infrared printing by clearing options.

For more information about IrMonitor, see its online help.

To set up a PC card or parallel port CD-ROM drive

The general steps for setting up a PC card CD-ROM drive are as follows:

1. Copy the device drivers—from the installation software provided with the CD-ROM drive—to the *Support Utility* disk into the `A:\tools` directory.
2. Add the `device=driver` statements to the `CONFIG.SYS` file on the Support Utility disk. The device statements should immediately follow the `[USERCD]` label.
3. Check the `AUTOEXEC.BAT` file to make sure that the CD-ROM drive is assigned as drive `G:`.

Before the OmniBook can recognize the CD-ROM drive, you'll need to edit the `CONFIG.SYS` and `AUTOEXEC.BAT` files on the *Support Utility* disk. The required device-drivers statements come from the CD-ROM manufacturer.

What you'll need from your CD-ROM manufacturer

1. The names of the device drivers to copy to the Support Utility disk.
2. The `device=drivers` statements to add the `CONFIG.SYS` file.
3. Statements that the CD-ROM drive *may* need to add to the `AUTOEXEC.BAT` file.

Hint

Both the `CONFIG.SYS` and `AUTOEXEC.BAT` files contain comments that should help your CD-ROM manufacturer advise you in editing the files to meet the particular requirements for your device

Changing the Configuration

Changing the Configuration

This chapter describes the OmniBook tools and utilities that come with the OmniBook. Use them to view and adjust configuration settings.

This chapter describes

- ◆ HP User Tools (Windows 95 operating system only).
- ◆ OmniBook Tools (Windows for Workgroups operating systems only).
- ◆ System Configuration Utility (operating-system-independent).



Changing the Configuration

For any operating system, you can use the System Configuration Utility (SCU) to change OmniBook configuration settings. For Windows 95 and Windows for Workgroups, you can also use a Tools application in Windows. The SCU provides more options for certain settings. The following chart summarizes the OmniBook settings. See the sections of this chapter for details.

Settings	HP User Tools (Windows 95)	OmniBook Tools (Windows for Workgroups)	SCU
Display, keyboard, pointer			
Display resolution	x	x	
Display switching	x	x	x
Keyboard setup		x	x
External keyboard setup			x
Pointing device setup		x	
External pointer setup			x
Power management			
Power, time-out setup	x	x	x
Advanced power setup			x
Battery charging			x
Connections			
Printer setup	x	x	
PC card setup	x	x	
COM port setup		x	x
LPT port setup			x
SCSI BIOS setup			x
Security			
Password setup	x	x	x
PC identification	x	x	x
Hard disk security			x
Other			
Date and time	x	x	x
Sound volume		x	x
Boot setup			x
Drive types			x
Cache setup			x
Memory size	x	x	x
BIOS version	x	x	x
Uninstall software	x	x	

Using HP User Tools

HP User Tools give you a convenient way in Windows 95 to change the way your OmniBook looks and operates. For many settings, it's an alternative to using the System Configuration Utility.

To run HP User Tools

1. Click Start, HP User Tools.
2. Click the tabs and buttons for the changes you want to make. You're prompted if you need to reboot the computer. Click Help or see the table below for more information.
3. After you make the changes, exit HP User Tools.

Information 1	Opens the OmniBook User's Guide and other online sources of information.
Information 2	Shows the HP software license agreement, and shows the BIOS version and the amount of system memory.
Setup	
OmniBook	<p>Display Sets whether the built-in display is on or off when an external display is present.</p> <p>Password "Set User Password." The user password doesn't give access to protected administrator options. "User Password Required" sets whether a password is required when the computer starts, before undocking, or when changing OmniBook settings such as those in the SCU. "Set Admin Password." The administrator password provides protection equal to the user password plus PC ID and OmniBook setting protection. The administrator password can be used whenever the user password is requested, such as when changing the user password. "Admin Password Required" sets whether PC ID and OmniBook setting changes are protected by the administrator password.</p> <p>Power "Options for Battery Power" balances the tradeoffs between power savings and performance speed while</p>

Changing the Configuration
Using HP User Tools

	operating on battery power. Click Custom to set time-outs individually. "Idle Time Before Turn-Off" shows the individual time-outs for operation on battery power.
Date/Time	Sets date, time, and time zone.
Display	Sets display properties, including resolution and color palette settings.
Printers	Opens the Printers folder for setting up and controlling printers.
PC Card	Sets PC Card properties, including identification, settings, and taskbar setup.
Control Panel	Opens the Windows Control Panel for changing other settings.
Advanced	
PC Identification	Lets you define four text strings for name, title, company, address, phone, etc.
Uninstall	Lets you remove selected sets of OmniBook software from the hard disk drive.

Using OmniBook Tools

OmniBook Tools give you a convenient way in Windows for Workgroups to change the way your OmniBook looks and operates. For many settings, it's an alternative to using the System Configuration Utility.

To run OmniBook Tools

1. In Program Manager, double-click the OmniBook Tools icon (in the Main group).
2. Click the buttons for the changes you want to make. You're prompted if you need to reboot the computer. Click Help or see the table below for more information.
3. After you make the changes, exit OmniBook Tools.

Personalize	Lets you define four text strings for name, title, company, address, phone. Lets you set date, time, and international settings.
Display	OmniBook Display Sets whether the built-in display is on or off when an external display is present. Display Resolution Sets the number of dots used to display the entire screen image and the number of colors available—for the built-in display or a display connected to the VGA output.
Sound	
Volume and Mixer	Opens the Volume-Mixer window for adjusting volume and balance.
Media Player	Starts the Windows Media Player application.
Sound Recorder	Starts the Windows Sound Recorder application.
Connections	
Docking	"Docking Prompts" sets whether reminder messages appear when you dock or undock and whether a password is required to undock, if you have a password.

COM Ports	Sets serial and infrared port addresses and interrupts.
Printers	Sets printer options.
Card Slots	Starts the CardWizard application for managing PC cards.
Infrared Communications	Starts IrMonitor or sets when it starts. IrMonitor provides IrDA communications capability.
Input Devices	
Pointing Devices	Sets pointing device or mouse settings.
Keyboard	Sets keyboard repeat settings.
Power Management	<p>Options for Battery Power Balances the tradeoffs between power savings and performance speed while operating on battery power. Click Custom to set time-outs individually.</p> <p>Idle Time before Turn-Off Shows the individual time-outs.</p>
Uninstall	Lets you remove selected sets of OmniBook software from the hard disk.
Password	<p>Set Admin Password The administrator password provides protection equal to the user password plus PC ID and OmniBook setting protection. The administrator password can be used whenever the user password is requested, such as when changing the user password.</p> <p>Admin Password Required Sets whether changes to PC ID and OmniBook settings are protected by the administrator password.</p> <p>Set User Password The user password protects certain events, but doesn't give access to protected administrator options, such as PC ID.</p> <p>User Password Required Sets whether a password is required when the computer starts, before undocking, or when changing OmniBook settings such as those in the SCU.</p>
Library	Opens the OmniBook User's Guide and other online sources of information.
(Control menu, About)	Shows the BIOS version and the amount of system memory.

Using the System Configuration Utility

The System Configuration Utility (SCU) provides access to basic configuration settings. It is independent of the operating system.

To run the SCU (during reboot)

1. Close all applications, then shut down Windows and reboot the OmniBook. If necessary, you can press Ctrl+Alt+Del to reboot.
2. During reboot, at the message “<F2> to enter System Configuration Utility,” press F2 to start the SCU.
3. The mouse is not active in the SCU. Press Alt to activate menus, and use the Tab key, arrow keys, spacebar, ENTER, and ESC to navigate and change settings. See the tables below for more information.
4. After you select the options you want, use the Exit menu to close the SCU.
5. Certain settings require that you reboot the OmniBook before they take effect. We recommend rebooting after changing SCU settings.

To run the SCU without rebooting

This method is not supported by certain operating systems, such as OS/2.

1. Save your data in any open applications.
2. Press Fn+F2 simultaneously to start the SCU.
3. The mouse is not active in the SCU. Press Alt to activate menus, and use arrow keys, spacebar, ENTER, and ESC to navigate and change settings. See the tables below for more information.
4. After you select the options you want, use the Exit menu to close the SCU. Certain settings require that you reboot the OmniBook before they take effect.

The following table describes the action required when changing SCU options:

Date and Time	Sets the date and time.	Reboot required.
Boot Devices	<p>Boot Device</p> <p>FDD First. The typical PC boot, where drive A is searched first for a system disk, then drive C.</p> <p>HDD Only. Boots the computer from drive C only. Provides protection from boot-sector virus.</p> <p>Boot Configuration</p> <p>Full. Configures all Plug and Play devices, such as needed for DOS or Windows 3.x.</p> <p>Boot devices only. Configures just. The keyboard, display, and disk, such as needed for Windows 95.</p> <p>Auto-detect. Detects the current operating system and boots the appropriate configuration.</p> <p>Fast Boot. Skips the RAM test.</p> <p>Enable SCSI BIOS. Enable only if drivers aren't available for the operating system.</p> <p>Enable boot sector virus check. Avoids a potential boot sector message during reboot.</p>	Reboot required.
Docking Messages	On or off. Provides prompts during docking and undocking.	Save required.
Passwords		
Password options	<p>Administrator Password. Sets whether PC ID and SCU-type changes are protected by the administrator password.</p> <p>User Password. Sets whether a user password is required when the computer turns on, before undocking, or when making SCU-type changes. .</p> <p>Disable hard disk drive lock. Sets whether a user password with turn-on security can secure data on the hard disk when in another computer.</p>	Immediate.
Set Admin password	The administrator password provides protection equal to the user password plus PC ID and SCU protection. The administrator password can be used whenever the user password is requested, such as when changing the user password.	Immediate.

Changing the Configuration
Using the System Configuration Utility

Set User password	The user password protects user events selected in Password Options, but doesn't give access to protected administrator options, such as PC ID.	Immediate.
PC Identification	Four text strings for name, company, address, phone.	Immediate.
Internal Cache	Enables faster performance by using internal processor memory.	Reboot required.
External Cache	Enables faster performance by using external cache memory.	Reboot required.
Disks menu		
Floppy Disk Drive	Specifies the type of floppy disk drive.	Reboot required.
Hard Disk Drive	Specifies the type of hard disk for a nonstandard hard disk.	Reboot required.
Input/Output menu		
COM Ports	Sets serial and infrared port addresses and interrupts.	Reboot required.
LPT Port	Sets printer port address.	Reboot required.
LPT Type	Sets printer port communication.	Reboot required.
Keyboard Setup	<p>Key Delay. Sets how long you hold a key down before the character starts repeating.</p> <p>Key Repeat Rate. Sets how fast characters repeat.</p> <p>Keyboard Numlock. Sets whether Num Lock is active after rebooting.</p>	Reboot required.
External devices	<p>VGA Display device. Sets whether the built-in display is on or off when an external display is present.</p> <p>Force recognition of external VGA. Overrides automatic detection of an external display.</p> <p>Enable External Fn Key. Lets you press Ctrl+Alt instead of Fn on an external keyboard with no Fn key.</p> <p>Ignore External Pointing Device. Activates the built-in pointing device when an external mouse is connected.</p>	Save required.
Audio Port	Sets the volumes for the beeper signal and the sound speaker.	Save required.
Power menu		
Power Controls	Power Saving should be On for power savings, Off for no power management. If an Advanced Power Management driver is loaded, power	Reboot required.

	<p>saving is active regardless of this setting.</p> <p>Suspend, Auto Hibernate, HDD power-down, CPU power-down are automatic turn-off times when operating on battery power.</p> <p>Enable Hibernate enables or prevents saving and restoring a session from the hard disk.</p> <p>Time-out during screen activity permits automatic suspend if the only activity is display activity.</p> <p>HDD power-down when on AC permits the hard disk to turn off when operating on ac power.</p> <p>Disable low battery message can block this message if it interferes with the operating system.</p>	
Battery Charging	Sets the order for charging two batteries. Only one battery charges at a time.	Save required.
Exit menu		
Save and Exit	Saves changes and exits without rebooting.	
Save and Reboot	Saves changes and reboots the computer.	
Exit (No Save)	Discards changes and exits.	
Default Settings	Resets all settings to defaults without exiting.	Reboot suggested.
Restore Settings	Discards changes without exiting.	
Version Info	Shows the BIOS version.	

— Troubleshooting



Troubleshooting

If you run into problems getting your OmniBook started, you can use the suggestions in this chapter for getting back on track.

Hints

If you're having a problem—and Windows is running on your OmniBook—see the online OmniBook *User's Guide*. Its troubleshooting chapter contains more troubleshooting information.

If you're having a problem within one particular application, check the manual for that application, too.

If you have questions that this manual doesn't answer, you can

- See the online OmniBook *User's Guide*—it's your main source of information about using the OmniBook. It includes extensive troubleshooting information.
- If you're using Windows for Workgroups, check the online *Windows Quick Start* and *MS-DOS Quick Start* manuals.
- If you're using Windows 95, check the printed *Introducing Microsoft Windows* manual.
- Look at the online Help for Windows and other applications.
- Check with your computer system administrator, if you have one.
- See other books about Windows, MS-DOS, and other applications. Check your local library or bookstore.
- Contact your dealer, or contact Hewlett-Packard—see the OmniBook *Support and Service* booklet or OmniBook Support in the online OmniBook Library.
- Get information about system resources (interrupts, addresses, and memory)—see “Software System Resources” on page 6-4.
- Find technical information about the OmniBook on the Internet—visit the World-Wide Web support site at <http://www.hp.com/go/omnibook>.

Solving Basic Problems

If your OmniBook has a problem starting, find the symptom below that matches your situation. Try the suggestions one at a time.

If the OmniBook turns off immediately after it turns on

- Battery power is probably extremely low. Plug in the ac adapter, or insert a charged battery pack.

If the OmniBook stops responding

- Press the blue On/Suspend button and wait a few moments until the icons on the status panel stabilize. Then press the blue button again to turn the OmniBook back on.
If necessary, press Ctrl+Alt+Del to reboot.
- If nothing happens, insert a paper clip or other slender object into the reset slot on the left side of the case, below the ac adapter socket. Push in momentarily—the system should reset and reboot.

If the OmniBook doesn't respond at turn-on

- Connect the ac adapter.
- Press On/Suspend to try turning on the unit.
- Insert a insert a paper clip or other slender object into the reset slot in the left side of the case, below the ac adapter socket. Push in momentarily—the system should reset and reboot.

If you get no response, remove the battery and ac adapter and reset the OmniBook again—then plug in the ac adapter and try resetting again. If you still get no response, the unit requires service.

If the cursor sometimes drifts on the screen

The TrackPoint is constantly being calibrated and sometimes the cursor drifts during the process. If this occurs, remove your finger from the TrackPoint for 3 seconds to allow proper calibration.

If the OmniBook doesn't reboot successfully

If your operating system is MS-DOS or Windows for Workgroups

- If no text is displayed, or if things stop before you see any text about MS-DOS, the unit probably requires service.
- If you see error messages during startup, but Windows starts or you get an MS-DOS prompt, exit Windows. Then type `scandisk` to fix problems with drive C. Then press `Ctrl+Alt+Del` to reboot—but at the “MS-DOS Startup Menu,” press `F8` `ENTER` and step through each startup command to find where the problem occurs. Repair or restore the necessary files as indicated.
- If you see text about MS-DOS but things stop before Windows starts or before you get an MS-DOS prompt, insert the *Support Utility* disk or other boot disk in the floppy disk drive, then press `Ctrl+Alt+Del` to reboot from drive A—then click the Minimum Startup option. (If the unit doesn't reboot from a floppy boot disk, the unit probably requires service.)

If it reboots, type `dir c:` to see if drive C contains valid files. Then try the following:

- If drive C has valid files, try typing these commands:

`scandisk c:` (to repair any defects)

`sys a: c:` (to restore core MS-DOS files).

- Last resort: The following commands delete all files on drive C, so you must reinstall your files after running these commands:

`fdisk` (to reinitialize drive C)

`format c: /u` (to prepare drive C for storing data)

If it still doesn't start, try reinstalling the Windows for Workgroups files on drive C—see page 2-6.

If your operating system is Windows 95

- If no text is displayed during reboot, or if things stop before you see “Starting Windows 95...”, the unit probably requires service.
- If you see “Starting Windows 95...” during startup followed by error messages, reboot again—but when you see “Starting Windows 95...”, press `F8` to get the startup menu. Click a startup option that might help you discover or fix the problem.
 - Use the “safe mode” option to start Windows with a basic configuration. Run ScanDisk (in System Tools) to fix problems with drive C. You can also make other changes to repair your startup files.

- Use the “step-by-step” option to step through each startup command to find where problems occur, so you can repair or restore any files indicated.
- If drive C (the hard disk) isn’t working properly, insert the *Support Utility* floppy disk in the floppy disk drive, then press Ctrl+Alt+Del to reboot from drive A—then click the Minimum Startup option. At the MS-DOS prompt, type `scandisk c:` to fix certain problems with drive C. You can use other commands on drive A to try to repair drive C. Then remove the floppy disk and try rebooting again. If it still doesn’t start, try reinstalling the original Windows 95 files on drive C.

If your system password doesn’t work

- Check whether Num Lock is off. Try changing it.
- If you’ve forgotten your password, have your OmniBook at hand and call Hewlett-Packard at the phone number in the *Service and Support* booklet.

If the screen is difficult to read

- Set the display resolution to its original setting—800×600 (SVGA) or 1024×768 (XGA). For Windows for Workgroups, use Display in OmniBook Tools. For Windows 95, use Display in HP User Tools.
- Try adjusting the display controls below or to the right of the screen.
- Try changing the color scheme. For Windows for Workgroups, use Display in OmniBook Tools. For Windows 95, use Display in HP User Tools.

**Specifications and Regulatory
Information**



Specifications and Regulatory Information

Your OmniBook is designed to provide trouble-free operation. The following suggestions can help you maintain its dependability:

- Observe the temperature limits and other specifications listed in the next section.
- Check out the tips about ergonomics and work habits.
- If you have problems, see the problem-solving suggestions in chapter 5 of this manual.
- If you think your OmniBook might need repair service, see the warranty and service information in the *Support and Service* booklet.

To contact Hewlett-Packard: If you have questions that this manual and the online OmniBook manuals don't answer (even after looking in the contents and index), you can contact Hewlett-Packard at the address or phone number listed in the *Support and Service* booklet or in OmniBook Support in the online OmniBook Library. Please have your OmniBook with you.

To clean the OmniBook: You can clean the OmniBook with a soft cloth dampened either in clean water or in water containing a mild detergent. Do not use an excessively wet cloth nor allow water inside the case. Do not use any abrasive cleaners, especially on the display. *Do not apply any cleaner directly to the display.* Instead, apply the cleaner to a soft cloth and then gently wipe the display. You can clean the keyboard with a vacuum cleaner to remove accumulated dust.

Hardware Specifications

Display	Backlit liquid-crystal display (LCD). SVGA (800 x 600 dots) or XGA (1024x768 dots) up to 16M colors.
Keyboard	Enhanced PC functionality with compact layout. Embedded numeric keypad. Tilt feet to change keyboard angle Pointing device.
Memory	RAM: 16 MB or more (depending on the model), expandable to 128 MB maximum.
Mass Storage	Card slots: two PC card slots available (two type I or type II cards or one type III card). Hard disk drive: 1 removable 2.5-inch IDE drive. Floppy disk drive: 1 removable 3.5-inch 1.44-MB floppy disk drive.
Interfaces	Serial: one 9-pin 115,200-baud RS-232 port (with hardware handshaking). Parallel: one 25-pin bi-directional parallel port. Infrared: one 4-Mbps bi-directional IrDA port. SVGA output: one SVGA port with up to 256-color 1280 x 1024 resolution. Card slots: PC card I/O cards (two type I or type II cards or one type III card). MIDI: one mini D-sub 15-pin connector and adapter. Docking port: one custom port for docking station.
Card Slots	Electrical: PC card version 2.1 cards. Mechanical: PC card type I, II, and III cards.
AC Adapter	Input: 115 to 240 Vac (50 to 60 Hz). Output: 12 Vdc, 3.3 A. Polarity: negative (inner contact is negative).
Battery Pack	F1193B 14.4 vdc lithium-ion 2.5 AH F1194B 14.4 vdc lithium-ion 3.75 AH
Temperature	Operating: 10 to 35 °C (50 to 95 °F) on TFT, 5 to 35 °C (41 to 95 °F) on DSTN. Storage: -40 to +60 °C (-40 to 140 °F). The unit may not operate properly below 5 °C (41 °F), but it can be stored at temperatures down to -40 °C (-40 °F) without damaging the hardware.
Humidity	Operating: 90% relative humidity at 35 °C (95 °F) maximum. Storage: 90% relative humidity at 60 °C (140 °F) maximum.
Audio System	Built-in 16-bit Sound Blaster-compatible stereo sound card, microphone and speakers.

Software System Resources

Below are default values for the system resources. To see other, non-default possibilities, refer to the System Configuration Utility, which lists port and audio device configurations in the Input/Output menu.

System Resources

The tables in this section show typical resource usage as set up by the OmniBook BIOS. Plug-and-play operating systems, drivers, and SCU settings may change some of the entries.

System Interrupts

0	System timer
1	Keyboard
2	Redirect IRQ 9
3	COM2 and COM4 (undocked) / Free (docked)
4	COM1 and COM3 (serial port)
5	Crystal sound
6	Floppy disk drive
7	LPT1 (parallel port)
8	Real-time clock
9	MIDI
10	PCI-type interrupt: CardBus (undocked) / SCSI (docked)
11	Free
12	Mouse
13	Coprocessor
14	Internal hard disk (primary IDE controller)
15	Internal CD-ROM (secondary IDE controller)

System Memory

C000 -CAFFF	Chips & Technologies video BIOS
CB000 -CBFFF	Enhanced parallel port BIOS
CC000 -E7FFF	Free (see below)
E8000 -FFFF	Plug-and play, PCI, and system BIOS

Valid uses for memory addresses CC000-E7FFF:

- Upper memory blocks (UMBs) in the range CC000-E7FFF.
- PC card and ISA/PCI card memory windows in the range CC000-DFFFF.
- ISA/PCI card boot ROM in the range CE000-DFFFF.

System Input/Output Addresses (100 -3FF)

170-177	Secondary HDD controller (internal CD-ROM)
1F0-1F7	Internal hard disk
200-207	Joystick
220-22F	Crystal sound
2F8-2FF	COM2 (infrared port)
330-331	MPU 401 (MIDI)
376	Secondary HDD controller (internal CD-ROM)
378-37F	LPT1 (printer port)
388-38B	Sound
3B0-3BB	VGA adapter
3C0-3DF	VGA adapter
3E0-3E1	PC card bridge on PCI
3F0-3F5	Floppy controller
3F6	Primary HDD controller
3F7	Floppy controller
3F8-3FF	COM1 (serial port)

DMA Channels

0	Sound record
1	Sound playback
2	Floppy disk drive
3	Fast IR
4	DMA controller
5	Free
6	Free
7	Free

Safety Information

Power Cord, Plug, and Voltage Requirements

The power cord supplied with the OmniBook ac adapter should match the plug and voltage requirements for your local area. Regulatory approval for the ac adapter has been obtained using the power cord for the local area. However, if you travel to a different area and need to connect to a different outlet or voltage, you should use one of the power cords listed below. To purchase a power cord (including one for a country not listed below) or a replacement ac adapter (HP part number F1044B), contact your local Hewlett-Packard dealer or Sales and Service office.

Power Cords

Country	Rated Voltage and Current	AC Plug Type	HP Part Numbers
Canada Mexico Philippines Taiwan United States	125–127 Vac (10 A)	NEMA 5-15P	8120-1348 (2.3 m) –or– 8120-6260 (1.0 m)
United States	250 Vac (6 A)	NEMA 6-15P	8120-0698 (2.5 m)
East and West Europe Egypt Saudi Arabia	250 Vac (10 A)	CEE 7-VII	8120-1689 (2 m) –or– 8120-6262 (1.0 m)
Hong Kong Singapore United Kingdom	250 Vac (5 A)	BS 1363A	8120-1351 (2.3 m) –or– 8120-6261 (1.0 m)
Australia New Zealand People's Republic of China	250 Vac (7.5 A)	AS3112	8120-1369 (2 m) –or– 8120-6346 (1.0 m)
Switzerland	250 Vac (6 A)	SEV Type 12	8120-2104 (2 m)
Denmark	250 Vac (6 A)	Danish AFSNIT 107	8120-2956 (2 m)
Japan	125 Vac (12 A) 125 Vac (7 A)	MITI 41-9682 MITI 41-7275	8120-5342 (2.5 m) 8120-6768 (0.2 m)
India South Africa	250 Vac (10 A)	IEC 83-B1	8120-4211 (2.0 m)

CAUTION

Use only the ac adapter shipped with the OmniBook (HP part number F1044B). *Using any other adapter could damage the OmniBook and void your warranty.* Always plug the ac adapter into a grounded outlet. Also, the adapter plug has negative polarity —the inner contact is negative, and the outer is positive.

Battery Safety

- To avoid risk of fire, burns, or damage to your battery pack, do not allow a metal object to touch across the battery contacts.
- The battery pack is suitable for use only with an HP OmniBook 2000/5700 and F1338A battery charger.
- Do not disassemble. There are no serviceable parts inside.
- Do not dispose of the battery pack in fire or water.
- Handle a damaged or leaking lithium-ion battery with extreme care. If you come in contact with the electrolyte, wash the exposed area with soap and water. If it contacts the eye, flush the eye with water for 15 minutes and seek medical attention.
- Do not expose the battery pack to high storage temperatures—above 60 °C (140 °F).
- When the battery is not in use, store it in the battery pouch provided.
- When discarding a battery pack, contact your local waste disposal provider regarding local restrictions on the disposal or recycling of batteries.
- To obtain a replacement battery, contact your local dealer or HP sales office.
- Do not charge the battery pack if the ambient temperature exceeds 45 °C (113 °F).

Laser Safety

The CD-ROM drive used with the OmniBook is certified as a Class 1 laser device according to the U.S. Department of Health and Human Services (DHHS) Radiation Performance Standard and International Standards IEC 825 / IEC 825-1 (EN60825 / EN60825-1). This device is not considered harmful, but the following precautions are recommended:

- Ensure proper use by reading and following the instructions carefully.
- If the unit requires service, contact an authorized HP service center—see the *OmniBook Support and Service* booklet.
- Do not attempt to make any adjustment of the unit.
- Avoid direct exposure to the laser beam—do not open the unit.

CLASS 1 LASER PRODUCT
LASER KLASSE 1

LED Safety

The infrared port located on the back panel of the OmniBook is classified as a Class 1 LED (light-emitting diode) device according to International Standard IEC 825-1 (EN60825-1). This device is not considered harmful, but the following precautions are recommended:

- If the unit requires service, contact an authorized HP service center—see the *OmniBook Support and Service* booklet.
- Do not attempt to make any adjustment of the unit.
- Avoid direct eye exposure to the infrared LED beam. Be aware that the beam is invisible light and cannot be seen.
- Do not attempt to view the infrared LED beam with any type of optical device.

CLASS 1 LED PRODUCT
LEDSCHÜTZKLASSE 1 PRODUKT

Working in Comfort

Ergonomics is the science that fits products to people. Its goal is to make products easy, enjoyable, safe, and efficient to use. However, with even the best designed equipment, how you use the product is very important.

You can use your OmniBook virtually anywhere, anytime, so following the guidelines below can be a challenge—but your efforts will be worthwhile, and help ensure that your OmniBook is ergonomically effective for you.

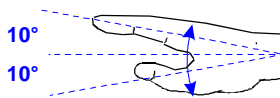
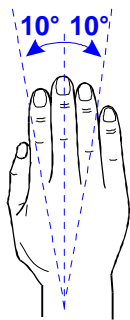

- Place your OmniBook directly in front of you, within easy reaching distance for your hands when your arms are hanging straight down at your side (this is about 16 inches, or 40 centimeters, in most cases).
- Whenever possible, adjust your seat height, work surface, or both to position the surface at approximately elbow height.
- Try not to use a lot of force when typing—type as lightly as possible. The OmniBook keyboard requires little force to activate, and excess force during typing may increase the risk of injury to you in the long term.
- Do not rest your wrists on a sharp edge when typing. Whenever possible, find a work surface edge that is rounded or padded, or position yourself so your hands rest on the surface, not its edge.
- When typing, try to find positions where you can sit with your arms (shoulder to elbow) straight down at your sides, and try not to hold your arms out away from your body (angle less than 20 degrees).
- Position the keyboard so your wrists, hands, and fingers are in a “neutral” line while typing. This means they do not tilt up or sideways more than 10 degrees.
- Shift positions and move your body from time to time—keeping your body “locked” in one position for a long period of time is unnatural and stressful.
- Take short (about 2 minutes or so) breaks whenever you feel fatigued, tired, or stiff—or at least once every hour. Use the breaks to gently stretch your hands, fingers, arms, and shoulders.

Regulatory Information

This section presents information that shows how the OmniBook 2000/5700 complies with regulations in certain regions. Any modifications to the OmniBook not expressly approved by Hewlett-Packard could void the authority to operate the OmniBook in these regions.

U.S.A.

The OmniBook 2000/5700 generates and uses radio frequency energy and may interfere with radio and television reception. The OmniBook complies with the limits for a Class B computing device as specified in Part 15 of FCC Rules, which provide reasonable protection against such interference in a residential installation. The “FCC ID” number for this product is listed on the bottom of the unit. In the unlikely event that there is interference to radio or television reception (which can be determined by removing the unit’s batteries and ac adapter), try the following:

- Reorienting or relocating the receiving antenna.
- Relocating the OmniBook with respect to the receiver.
- Connecting the OmniBook ac adapter to another power outlet.

Connections to Peripheral Devices

To maintain compliance with FCC Rules and Regulations, use properly shielded cables with this device.

For more information, consult your dealer, an experienced radio/television technician, or the following booklet, prepared by the Federal Communications Commission: *How to Identify and Resolve Radio-TV Interference Problems*. This booklet is available from the U.S. Government Printing Office, Washington, DC 20402, Stock Number 004-000-00345-4. At the first printing of this manual, the telephone number was (202) 512-1800.

Canada

This digital apparatus does not exceed the Class B limits for radio noise emissions from digital apparatus as set out in the radio interference regulations of the Canadian Department of Communications.

Le présent appareil numérique n'émet pas de bruits radioélectriques dépassant les limites applicables aux appareils numériques de Classe B prescrites dans le règlement sur le brouillage radioélectrique édicté par le Ministère des Communications du Canada.

Japan

この装置は、情報処理装置等電波障害自主規制協議会（VCCI）の基準に基づく第二種情報技術装置です。この装置は、家庭環境で使用することを目的としていますが、この装置がラジオやテレビジョン受信機に近接して使用されると、受信障害を引き起こすことがあります。

取扱説明書に従って正しい取り扱いをして下さい。

Europe

Products sold in Europe by Hewlett-Packard and its authorized dealers meet the specifications listed below.

Declaration of Conformity (according to ISO/IEC Guide 22 and EN 45014)

Manufacturer:	Hewlett-Packard Company
Address:	Hewlett-Packard Co. Mobile Computing Division 1000 NE Circle Blvd. Corvallis, OR 97330
Product name:	declares that the following product HP OmniBook 2000/5700, all models
Options:	All
Safety:	conforms to the following product specifications IEC 950:1991+A1,A2 / EN 60950 (1992)+A1,A2 IEC 825-1:1993/EN60825-1:1994, Class 1
EMC:	CISPR 22:1993 / EN 55022 (1994): Class B [1]] EN 50082-1:1992 IEC 801-2:1991 / prEN 55024-2 (1992): 4kV CD, 8kV AD IEC 801-3:1984 / prEN 55024-3 (1991): 3V/m IEC 801-4:1988 / prEN 55024-4 (1992): 0.5 kV signal lines, 1.0kV power lines
Supplementary Information:	The product herewith complies with the requirements of the Low Voltage Directive 73/23/EEC and the EMC Directive 89/336/EEC. The HP F1044B ac adapter used with this product is designed to operate on all power systems, other than IT power systems. [1] The product was tested in a typical configuration with Hewlett-Packard personal computer peripherals.

Quality Department
Hewlett-Packard Company
Mobile Computing Division

Index

A

- ac power
 - icon, 1-18
- adapter
 - mouse/keyboard, 3-10
 - adapter (Y), 3-10
- addresses
 - Input/Output, 6-5
 - serial ports, 3-12
- adjusting
 - brightness, 1-9
 - display type, 3-8
 - volume, 1-11
- administrator password, 4-4
- advanced settings
 - serial ports, 3-12
- applications (HP), 2-10
- audio system
 - headphones, 1-11
 - microphone, 1-11
 - speakers, 1-11
 - volume, 1-11

B

- backup disks
 - creating DOS 6.22, 2-7
 - creating Windows for Workgroups, 2-7
- battery
 - charging, 1-4
 - icons, 1-18
 - installing, 1-3

- safety, 6-7
- BIOS resources, 6-4
- blocks (upper memory), 6-4
- board (expansion), 3-5

C

- Caps Lock icon, 1-17
- CardBus, 1-29
- cards
 - I/O port names, 3-11, 3-12
 - PC card status, 1-17
 - setting up PC card port, 3-15
- CD-ROM drive
 - reading from icon, 1-17
- channels (DMA), 6-5
- charging
 - battery, 1-4
- cleaning the OmniBook, 6-2
- connecting
 - headphones, 1-11
 - microphone, 1-11
 - speakers, 1-11
- Corporate Evaluator's Guide, 1-2, 2-9
- creating
 - DOS 6.22 backup disks, 2-7

D

- data storage, 1-17
- default values, 6-4
- disable infrared
 - printing, 3-14
- display (external)
 - adjusting type, 3-8
 - connecting, 3-8
- DMA channels, 6-5
- docking password, 4-6
- DOS 6.22 backup disks, 2-7
- drivers
 - installing, 2-9
 - reinstalling, 2-2

E

- ergonomics, 6-9
- expansion board, 3-5
- external
 - display type, 3-8
 - speaker volume, 1-11
 - speakers, 1-11

F

- factory-installed
 - operating system, 1-5
- FAT32, 2-2, 2-3
- floppy disk drive
 - icon, 1-17
- Fn keys
 - volume control, 1-11

H

- hard drive
 - icon, 1-17
- headphones
 - (connecting), 1-11
- HP applications
 - installing, 2-10

I

- icons
 - ac power, 1-18
 - battery status, 1-18
 - Caps Lock, 1-17
 - CD-ROM drive
 - activity, 1-17
 - charging status, 1-18
 - floppy disk activity, 1-17
 - hard disk activity, 1-17
 - Num Lock, 1-17
 - PC card, 1-17
 - Scroll Lock, 1-17
 - status panel, 1-17
 - suspended state, 1-18
- inserting
 - PC cards, 1-29
- installing
 - battery, 1-3
 - factory-installed
 - operating system, 1-5
 - HP applications, 2-10
 - HP software, 2-3
 - operating systems, 2-3
 - OS/2 Warp, 2-9
 - Windows, 2-3
 - Windows 95, 2-4
 - Windows for
 - Workgroups, 2-6
 - Windows NT, 2-9
- interrupts
 - serial ports, 3-12
 - system, 6-4

K

- Kensington lock
 - attaching, 1-18
- keyboard
 - adjusting, 1-10
 - correct positioning, 6-9
 - status, 1-17

L

- laser safety, 6-8
- LED safety, 6-8
- license agreement, iii

M

- memory
 - system resource, 6-5
- microphone
 - (connecting), 1-11

N

- Num Lock
 - icon, 1-17

O

- OmniBook
 - cleaning, 6-2
 - Notes, 1-31
 - Website, 1-2, 1-31
- online User's Guide, 1-31
- operating systems
 - OS/2 Warp, 2-9
 - reinstalling, 2-2
 - Windows 95, 2-4
 - Windows for
 - Workgroups, 2-6
 - Windows NT, 2-9
- OS/2 Warp, 2-9
- OS/2 Warp Connect, 2-9

P

- passwords
 - administrator, 4-4

- docking, 4-6
 - forgotten, 5-5
 - in SCU, 4-9
 - in User Tools, 4-7
 - user, 4-4
 - PC cards
 - icons, 1-17
 - inserting, 1-29
 - setting up port, 3-15
 - plug requirements, 6-6
 - port
 - addresses, 3-12
 - assignments, 3-11
 - infrared, 3-9
 - interrupts, 3-12
 - keyboard, 3-10
 - mouse, 3-10
 - parallel, 3-9
 - PC card, 3-15
 - serial, 3-9, 3-11
 - settings, 3-12
 - Y-adapter, 3-10
 - power
 - cords, 6-6
 - status, 1-18
 - product specifications, 6-2
 - protecting OmniBook
 - with Kensington lock, 1-18
- ## R
- recovering Windows, 2-3
 - Recovery CD, 2-3, 2-4
 - regulatory information, 6-10
 - reinstalling
 - HP applications, 2-10
 - User's Guide, 2-2
 - Windows 95, 2-4
 - Windows for
 - Workgroups, 2-6
 - removing
 - PC card, 1-30

S

- safety
 - laser, 6-8
 - LED, 6-8
 - power, 6-6
 - voltage, 6-6
- Scroll Lock icon, 1-17
- SCU
 - setting passwords with, 4-9
- securing the OmniBook, 1-18
- security
 - attaching cable, 1-18
- serial port
 - addresses, 3-12
 - assignments, 3-11
 - interrupts, 3-12
 - settings, 3-12
- service, 6-8
- software
 - license, iii
 - resources, 6-4
- Sound Blaster, 1-11
- speakers (connecting), 1-11

- specifications, 6-2
 - software system, 6-4
- status
 - data storage, 1-17
 - keyboard, 1-17
 - power, 1-18
- status panel, 1-17
- super VGA, 3-8
- support, 6-8
- Support Utilities disk, 2-3
- Support Utility disk, 2-4
- system resources
 - DMA channels, 6-5
 - Input/Output
 - addresses, 6-5
 - memory, 6-5
 - system interrupts, 6-4

U

- upper memory blocks, 6-4
- user password, 4-4
- User Tools
 - setting passwords with, 4-7
- User's Guide (online)

- reinstalling, 2-2

V

- VGA format, 3-8
- voltage requirements, 6-6
- volume
 - adjusting, 1-11

W

- Warp Connect, 2-9
- Website (OmniBook), 1-2, 1-31
- Windows 95, 2-4
- Windows for
 - Workgroups, 2-6
- Windows NT, 2-9

X

- XGA format, 3-8

Z

- Zoomed Video, 1-29

