

Blu-ray Disc Player



User's Manual BD-P1400

SAMSUNG



key features of your new Blu-ray Disc Player

Player Features

Digital Photo Viewer (JPEG)

You can enjoy digital photos on your TV.

MP3 Playback

This unit can play mp3 files from CD-R/-RW, DVD-R/-RW discs.

HDMI (High Definition Multimedia Interface)

HDMI reduces picture noise by allowing a pure digital video/audio signal path from the player to your TV.

Simplay HD

Simplay HD guarantees that this player has been tested according to specifications aimed at maximizing the delivery of HD content.



Blu-ray Disc Features

Blu-ray Discs can store 25 GB (single layer) or 50 GB (dual layer) on a single sided disc - about 5 to 10 times the capacity of a DVD. Blu-ray Discs also support the highest quality HD video available in the industry (up to 1920 x 1080 at 40 Mbit/sec) - Large capacity means no compromise on video quality. Furthermore, a Blu-ray Disc has the same familiar size and look as DVD.

* The following Blu-ray Disc features are disc dependant and will vary.
Appearance and navigation of features will also vary from disc to disc.
Not all discs will have the features described below.

Video highlights

The BD-ROM format for movie distribution supports three highly advanced video codecs, including AVC, VC-1, and MPEG-2.

HD video resolutions are also available:

- 1920 x 1080 HD
- 1280 x 720 HD

For High-Definition Playback

To view high-definition contents in BD discs, an HDTV (High Definition Television) is required. Some discs may require using the player's HDMI OUT to view high-definition content. The ability to view high-definition content on BD discs may be limited depending on the resolution of your TV.

Graphic planes

Two individual, full HD resolution (1920x1080) video layers are available, on top of the HD video layer. One layer is assigned to video-related graphics (like subtitles), and the other layer is assigned to interactive elements, such as buttons or menus. Various wipes, fades and scroll effects may be available on both layers.



Menu graphics

Support 256 full color resolution graphics and animation, thereby greatly surpassing the capabilities of DVD-Video. Unlike DVD, Menus can be accessed during video playback.

Menu sounds

When you highlight or select a menu option on a Blu-ray Disc, sounds can be heard such as button clicks or a voice-over explaining the highlighted menu choice.

Multi-page/PopUp Menus

With DVD-Video, playback is interrupted each time a new menu screen is accessed. Due to Blu-ray Disc's ability to preload data from the disc without interrupting playback, a menu may consist of several pages.

You can browse through the menu pages or select different menu paths, while the audio and video remain playing in the background.



Interactivity

Certain Blu-ray Discs may contain Animated menus and Trivia games.

User Browsable Slideshows

With Blu-ray Discs, you can browse through various still pictures while the audio remains playing.

Subtitles

Depending on what is contained on the Blu-ray Disc, you may be able to select different font styles, sizes and colors for the subtitles, Subtitles may also be animated, scrolled or faded in and out.

WHAT'S INCLUDED

Check for the supplied accessories below.



Composite (Video), Audio L/R Cable
(MF39-00274A)



Batteries for Remote Control (AAA Size)
(4301-001035)

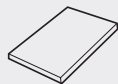

User Manual
(AK68-01454A)

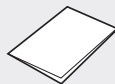

Quick Guide
(AK68-01455A)





Remote Control
(AK59-00070A)

safety information

WARNING

TO REDUCE THE RISK OF ELECTRIC SHOCK, DO NOT REMOVE THE COVER(OR BACK).
NO USER-SERVICEABLE PARTS ARE INSIDE. REFER SERVICING TO QUALIFIED SERVICE PERSONNEL.

	<div style="border: 1px solid black; padding: 5px; text-align: center;"> <p>CAUTION</p> <p>RISK OF ELECTRIC SHOCK DO NOT OPEN</p> </div>	
<p>The lightning flash and Arrowhead within Triangle is a warning sign alerting you of dangerous voltage Inside the product</p>	<p>CAUTION: TO REDUCE THE RISK OF ELECTRIC SHOCK, DO NOT REMOVE COVER (OR BACK) NO USER SERVICEABLE PARTS INSIDE. REFER SERVICING TO QULAIFIED SERVICE PERSONNEL.</p>	<p>The explanation point within the triangle is a warning sign alerting you of important instructions accompanying the product.</p>

WARNING

- To reduce the risk of fire or electric shock, do not expose this appliance to rain or moisture.
- To prevent injury, this apparatus must be securely attached to the floor/wall in accordance with the installation instructions.
- If this power supply is used at 240V ac, a suitable plug adapter should be used.

Note to CATV system installer

This reminder is provided to call CATV system installer's attention to Article 820-40 of the National Electrical Code (Section 54 of Canadian Electrical Code, Part I) that provides guidelines for proper grounding and, in particular, specifies that the cable ground shall be connected to the grounding system of the building as close to the point of cable entry as practical.

FCC NOTE (for U.S.A):

This equipment has been tested and found to comply with the limits for a Class B digital device, pursuant to Part 15 of the FCC rules. These limits are designed to provide reasonable protection against harmful interference in a residential installation. This equipment generates, uses and can radiate radio frequency energy and, if not installed and used in accordance with the instructions, may cause harmful interference to radio or television reception, which can be determined by turning the equipment off and on.

The user is encouraged to try to correct the interference by one or more of the following measures.

- Reorient or relocate the receiving antenna.
- Increase the separation between the equipment and receiver.
- Connect this equipment into an outlet on a circuit different from that to which the receiver is connected.
- Consult the dealer or an experienced radio/TV technician for help.

This class B digital apparatus meets all requirements of the Canadian Interference - Causing Equipment Regulations.

CLASS 1 LASER PRODUCT
KLASSE 1 LASER PRODUKT
LUOKAN 1 LASER LAITE
KLASS 1 LASER APPARAT
PRODUCTO LÁSER CLASE 1

CLASS 1 LASER PRODUCT

Use of controls, adjustments or performance of procedures other than those specified herein may result in hazardous radiation exposure.

CAUTION

THIS PRODUCT UTILIZES A LASER. USE OF CONTROLS OR ADJUSTMENTS OR PERFORMANCE OF PROCEDURES OTHER THAN THOSE SPECIFIED HEREIN MAY RESULT IN HAZARDOUS RADIATION EXPOSURE. DO NOT OPEN COVER AND DO NOT REPAIR YOURSELF. REFER SERVICING TO QUALIFIED PERSONNEL.

Note:

- This unit can be used only where the power supply is AC 120V, 60Hz. It cannot be used elsewhere.
- This Blu-ray Disc Player is designed and manufactured to respond to the Region Management Information. If the Region number of a BD/DVD disc does not correspond to the Region number of this Blu-ray Disc Player, the Blu-ray Disc Player cannot play the disc.

PRECAUTIONS

Important Safety Instructions

Read these operating instructions carefully before using the unit. Follow all the safety instructions listed below. Keep these operating instructions handy for future reference.

- 1) Read these instructions.
- 2) Keep these instructions.
- 3) Heed all warnings.
- 4) Follow all instructions.
- 5) Do not use this apparatus near water.
- 6) Clean only with dry cloth.
- 7) Do not block any ventilation openings, Install in accordance with the manufacturer's instructions.
- 8) Do not install near any heat sources such as radiators, heat registers, or other apparatus (including amplifiers) that produce heat.
- 9) Do not defeat the safety purpose of the polarized or grounding- type plug. A polarized plug has two blades with one wider than the other. A grounding type plug has two blades and a third grounding prong. The wide blade or the third prong are provided for your safety. If the provided plug does not fit into your outlet, consult an electrician for replacement of the obsolete outlet.
- 10) Protect the power cord from being walked on or pinched particularly at plugs, convenience receptacles, and the point where they exit from the apparatus.
- 11) Only use attachments/accessories specified by the manufacturer.
- 12) Use only with the cart, stand, tripod, bracket, or table specified by the manufacturer, or sold with the apparatus. When a cart is used, use caution when moving the cart/ apparatus combination to avoid injury from tip-over.
- 13) Unplug this apparatus during lightning storms or when unused for long periods of time.
- 14) Refer all servicing to qualified service personnel. Servicing is required when the apparatus has been damaged in any way, such as power-supply cord or plug is damaged, liquid has been spilled or objects have fallen into the apparatus, the apparatus has been exposed to rain or moisture, does not operate normally, or has been dropped.



safety information

Handling Cautions

- Before connecting other components to this Blu-ray Disc Player, be sure to turn them all off.
- Do not move the Blu-ray Disc Player while a disc is being played, or the disc may be scratched or broken, the Blu-ray Disc Player internal parts may be damaged.
- Do not put a flower vase filled with water or any small metal objects on the Blu-ray Disc Player.
- Be careful not to put your hand into the disc tray.
- Do not place anything other than the disc in the disc tray.
- Exterior interference such as lightning and static electricity can affect normal operation of this Blu-ray Disc Player. If this occurs, turn the Blu-ray Disc Player off and on again with the **POWER** button, or disconnect and then reconnect the AC power cord to the AC power outlet. The Blu-ray Disc Player will operate normally.
- Be sure to remove the disc and turn off the Blu-ray Disc Player after use.
- Disconnect the AC power cord from the AC outlet when you don't intend to use the Blu-ray Disc Player for long periods of time.
- Clean the disc by wiping in a straight line from the inside to the outside of the disc.
- Do not expose the player to dripping or splashing liquids.
- When the AC plug is connected to a wall outlet, the player will still draw power (standby mode) when it is turned off.

Maintenance of Cabinet

For safety reasons, be sure to disconnect the AC power cord from the AC outlet.

- Do not use benzene, thinner, or other solvents for cleaning.
- Wipe the cabinet with a soft cloth.

Restrictions on Playback

- This player may not respond to all operating commands because some BD, DVD or CD discs allow specific or limited operation and features during playback.
Please note that this is not a defect in the player.
- Samsung cannot assure that this player will play every disc bearing the BD, DVD and CD logos because disc formats may evolve, and problems and errors can occur during the creation of BD, DVD and CD software and/or the manufacture of discs.
This player also operates differently than a standard DVD player or other AV equipment. Please contact the SAMSUNG customer care center if you have questions or encounter difficulty in playing BD, DVD or CD discs in this player. Also, refer to the rest of this Manual for additional information on playback restrictions.

contents

KEY FEATURES OF YOUR NEW BLU-RAY DISC PLAYER

2

3 What's included

SAFETY INFORMATION

4

4 Warning
5 Precautions

GETTING STARTED

9

9 Before Reading the User's Manual
10 Disc Type and Characteristics
13 Disc Storage & Management

DESCRIPTION

14

14 Front Panel
14 Front Panel Display
15 Rear Panel

REMOTE CONTROL

16

16 Tour of the Remote Control
18 Setting the Remote Control
18 REGARDING THE BATTERY
19 Controllable TV Codes

CONNECTIONS

20

20 Connecting to a TV with HDMI Cable
21 HDMI Auto Detection Function
22 Connecting to a TV with DVI Cable
23 Connecting to a TV (Component)
24 Connecting to a TV (S-Video)
25 Connecting to a TV (Video)
26 Connecting to an Audio System (2 Channel Amplifier)
27 Connecting to an Audio System (5.1 Channel Amplifier)
28 Connecting to an Audio System (Dolby Digital, DTS Amplifier)
29 Connecting to an Audio System (HDMI supported Amplifier)
30 Connecting to Samsung's FTP/Internet site for Software Upgrades

BASIC FUNCTIONS OF YOUR BLU-RAY DISC PLAYER

31

31 Before Playing
32 On-Screen Menu Navigation
32 Playing a Disc
33 Using the Search and Skip Functions
33 Slow Motion Play/Step Motion Play

contents









SYSTEM SETUP	34	Setting up the Language Options
	35	Setting up the Audio Options
	37	Setting up the Speaker Options
	38	Setting up the Video display/output Options
	41	Setting up the HDMI setup options
	43	Setting up the Parental Lock
SYSTEM UPGRADE	45	Firmware Upgrade
	47	System Information
	47	Network Setup
WATCHING A MOVIE	49	Using the Display Function
	50	Using the Disc Menu & Popup/Title Menu
	51	Repeat Play
	51	Selecting the Audio Language
	52	Selecting the Subtitle Language
	53	Changing the Camera Angle
	53	Using the Bookmark Function
LISTENING TO MUSIC	55	Playing an Audio CD(CD-DA)
	55	Playing an MP3
	55	Audio CD(CD-DA)/MP3 Screen Elements
	56	Buttons on the Remote Control used for Audio CD(CD-DA)/ MP3 disc playback
	56	Repeat Audio CD(CD-DA) & MP3
VIEWING A PICTURE	58	Viewing a Picture
	58	Slide Show
	58	Rotate
	59	Zoom
	59	Go To Photo List
TROUBLESHOOTING	60	Troubleshooting
APPENDIX	62	Specifications
	64	Warranty (for USA users only)

getting started

BEFORE READING THE USER'S MANUAL

Make sure to check the following terms before reading the user manual.

Icons that will be used in manual

Icon	Term	Definition
	BD-ROM	This involves a function available on a BD-ROM.
	DVD-VIDEO	This involves a function available on DVD-Video or DVD-R/DVD-RW discs that have been recorded and finalized in Video Mode.
	DVD-RW	This involves a function available on DVD-RW. (V mode and finalized only)
	DVD-R	This involves a function available on DVD-R. (V mode and finalized only)
	Audio CD	This involves a function available on a data CD (CD-R or CD-RW).
	JPEG	This involves a function available on CD-R/-RW, DVD-R/-RW discs.
	MP3	This involves a function available on CD-R/-RW, DVD-R/-RW discs.
	Note	This involves tips or instructions on the page that help each function operate.

About the use of this user's manual

- 1) Be sure to be familiar with Safety Instructions before using this product. (See pages 4~6)
- 2) If a problem occurs, check the Troubleshooting. (See pages 60~61)

Copyright





©2007 Samsung Electronics Co.,Ltd.

All rights reserved; No part or whole of this user's manual may be reproduced or copied without the prior written permission of Samsung Electronics Co.,Ltd.

getting started











DISC TYPE AND CHARACTERISTICS

Disc types that can be played

Disc Types	Disc Logo	Recorded content	Disc Shape	Max. Playing minute
BD-ROM		AUDIO + VIDEO	Single sided (25GB/50GB)	Playing time depends on the Title
DVD-VIDEO		AUDIO + VIDEO	Single sided(5 inches)	240
			Double sided(5 inches)	480
			Single sided(3 1/2 inches)	80
			Double sided(3 1/2 inches)	160
AUDIO-CD		AUDIO	Single sided(5 inches)	74
			Single sided(3 1/2 inches)	20
DVD-RW (V mode and finalized only)		AUDIO + VIDEO	5 inches (4.7GB)	480 (EX : Extended Play)
DVD-R (V mode and finalized only)		AUDIO + VIDEO	5 inches (4.7GB)	480 (EX : Extended Play)
CD-R/-RW DVD-RW/-R		JPEG MP3	—	—

- This player is compatible with the NTSC color system only.
- PAL discs will not play.

Logos of Discs that can be played

			
Blu-ray Disc	Dolby Digital Plus	DTS-HD High Resolution Audio	
			
NTSC broadcast system in U.S.A, Canada, Korea, Japan	Dolby TrueHD	DTS-HD Advanced Digital Out	
			
Digital Audio	MP3	Stereo	Java

Discs that cannot be played



- Blu-ray Discs with a region code other than "Region A".
- BD-R, BD-RE
- HD DVD Disc
- DVD-Video with a region number other than "1" or "ALL"
- DVD-RAM
- 3.9 GB DVD-R Disc for Authoring.
- DVD-RW(VR mode)
- DVD-ROM/PD/MV-Disc, etc
- CVD/CD-ROM/CDV/CD-G/CD-I/LD

[Note]

- Some commercial discs and DVD discs purchased outside your region may not be playable with this product. When these discs are played, either "No disc." or "Please check the regional code of the disc." will be displayed.
- If a DVD-R/-RW disc has not been recorded properly in DVD video format, it will not be playable.
- The unit cannot play CD-R/-RW and DVD-RW/-R recorded content such as divx, avi, mpg, mov, wma.

Region code

Both the Blu-ray Disc Player and the discs are coded by region. These regional codes must match in order to play the disc. If the codes do not match, the disc will not play. The Region Number for this Blu-ray Disc Player is described on the rear panel of the Blu-ray Disc Player.

Disc Type	Blu-ray	DVD-Video
Region code		

BD Region Code	Area
A	North America, Central America, South America, Korea, Japan, Taiwan, Hong Kong and South East Asia.
B	Europe, Greenland, French territories, Middle East, Africa, Australia and New Zealand.
C	India, China, Russia, Central and South Asia.

Blu-ray Disc Compatibility

Blu-ray Disc is a new and evolving format. Accordingly, disc compatibility issues are possible. Not all discs are compatible and not every disc will play back. For additional information, refer to the Compliance and Compatibility Notice section of this Manual. If you encounter compatibility problems, please contact the SAMSUNG customer care center. This Samsung Blu-ray Disc Player (BD-P1400) supports only the BD-ROM Profile 1 version 1.0 specification. If you want to play later version discs, you may need to update player's firmware. Please refer to <http://www.samsung.com/us> or contact SAMSUNG customer care center at 1-800 SAMSUNG.



- Playback may not work for some types of discs, or when specific operations, such as angle change and aspect ratio adjustment, are being performed. Information about the discs is written in detail on the box. Please refer to this if necessary.
- Do not allow the disc to become dirty or scratched. Finger prints, dirt, dust, scratches or deposits of cigarette smoke on the recording surface may make it impossible to use the disc for playback.
- Discs with PAL programs recorded on them cannot be played using this product.
- When a BD-Java title is played, loading may take longer than a normal title, or some functions may perform slowly.

getting started

Disc Types

❖ **BD-ROM**

Blu-ray Disc Read Only Memory. A BD-ROM disc contains pre-recorded data. Although a BD-ROM may contain any form of data, most BD-ROM discs will contain movies in High Definition format, for playback on Blu-ray Disc Players. This unit can play back pre-recorded commercial BD-ROM discs.

❖ **DVD-Video**

- A digital versatile disc (DVD) can contain up to 135-minutes of images, 8 audio languages and 32 subtitle languages. It is equipped with MPEG-2 picture compression and Dolby Digital surround, allowing you to enjoy vivid and clear theatre quality images.
- When switching from the first layer to the second layer of a dual-layered DVD Video disc, there may be momentary distortion in the image and sound. This is not a malfunction of the unit.
- Once a DVD-RW/-R recorded in Video Mode is finalized, it becomes DVD-Video. Pre-recorded (pre-stamped) commercial DVDs with movies are also referred to as DVD-Videos. This unit can play back pre-recorded commercial DVD discs (DVD-Video discs) with movies.

❖ **Audio CD**

- An audio disc on which 44.1kHz PCM Audio is recorded.
- This unit can play back CD-DA format audio CD-R and CD-RW discs.
- The unit may not be able to play some CD-R or CD-RW discs due to the condition of the recording.

❖ **CD-R/-RW**

- Use a 700MB(80 minutes) CD-R/-RW disc. If possible, do not use a 800MB(90 minutes) or above disc, as the disc may not play back.
- If the CD-R/-RW disc was not recorded as a closed session, you may experience delays when playing back the beginning of the disc or all recorded files may not play.
- Some CD-R/-RW discs may not be playable with this unit, depending on the device which was used to burn them. For contents recorded on CD-R/-RW media from CDs for your personal use, playability may vary depending on contents and discs.

❖ **DVD-R Disc Playback**

- Once a DVD-R recorded in Video Mode is finalized, it becomes DVD-Video.
- This unit can play back DVD-R discs recorded and finalized with a Samsung DVD video recorder. It may not be able to play some DVD-R discs depending on the disc and the condition of the recording.

❖ **DVD-RW Disc Playback**

- Playback can be performed with DVD-RW discs in the Video Mode and finalized only.
- Once a DVD-RW recorded in Video Mode is finalized, it becomes DVD-Video. Ability to play back may depend on recording conditions.

Disc Format

❖ **Using MP3 disc**

- CD-R/-RW, DVD-RW/-R recorded with UDF, ISO9660 or JOLIET format can be played back.
- Only MP3 files with the “.mp3” or “.MP3” extension can be played.
- Playable bit-rate range is from 56 Kbps to 320 Kbps.
- Playable sample-rate is 16KHz to 48KHz.
- The unit can handle a maximum of 1500 files and folders under a parent folder. For MP3 files recorded with a VBR(Variable Bit Rates), the sound may cut in and out.

❖ **Using JPEG disc**

- CD-R/-RW, DVD-RW/-R recorded with UDF, ISO9660 or JOLIET format can be played back.
- Only JPEG files with the ".jpg", ".JPG", ".jpeg" or "JPEG" extension can be displayed.
- Progressive JPEG is supported.

❖ **DVD-RW/-R (V)**

- This is a format that is used for recording data on a DVD-RW or DVD-R disc. The disc can be played by this Blu-ray Disc Player once it has been finalized.
- If a disc that has been recorded in Video Mode by a different maker's recorder but has not been finalized, it cannot be played by this Blu-ray Disc Player.

DISC STORAGE & MANAGEMENT

Disc Handling

- Use discs with regular shapes. If an irregular disc (a disc with a special shape) is used, this Blu-ray Disc Player may be damaged.

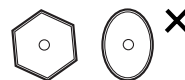
❖ **Holding discs**

- Avoid touching the surface of a disc where recording is performed.

❖ **Blu-ray Discs**

- If the player is not used for a long period of time, remove the Blu-ray Disc from the player and store it in its case.
- Be careful not to leave fingerprints or scratches on the surface of the Blu-ray Disc.

❖ **DVD-RW and DVD-R**

- Clean with an optional PD disc cleaner (LF-K200DCA1 where available). Do not use cleaners or cloths for CDs to clean DVD-RW/-R discs.

❖ **DVD-Video, Audio-CD**

- Wipe off dirt or contamination on the disc with a soft cloth.

❖ **Cautions on handling discs**

- Do not write on the printed side with a ball-point pen or pencil.
- Do not use record cleaning sprays or antistatic. Also, do not use volatile chemicals, such as benzene or thinner.
- Do not apply labels or stickers to discs. (Do not use discs fixed with exposed tape adhesive or leftover peeled-off stickers.)
- Do not use scratch-proof protectors or covers.
- Do not use discs printed with label printers available on the market.
- Do not load warped or cracked discs.



Disc Storage

Be careful not to harm the disc because the data on these discs is highly vulnerable to the environment.

- Do not keep under direct sunlight.
- Keep in a cool ventilated area.
- Store vertically.
- Keep in a clean protection jacket.
- If you move your Blu-ray Disc Player suddenly from a cold place to a warm place, condensation may generate on the operating parts and lens and cause abnormal disc playback. If this occurs, do not connect the plug to the power outlet and wait for two hours. Then insert the disc and try to play back again.

description

FRONT PANEL

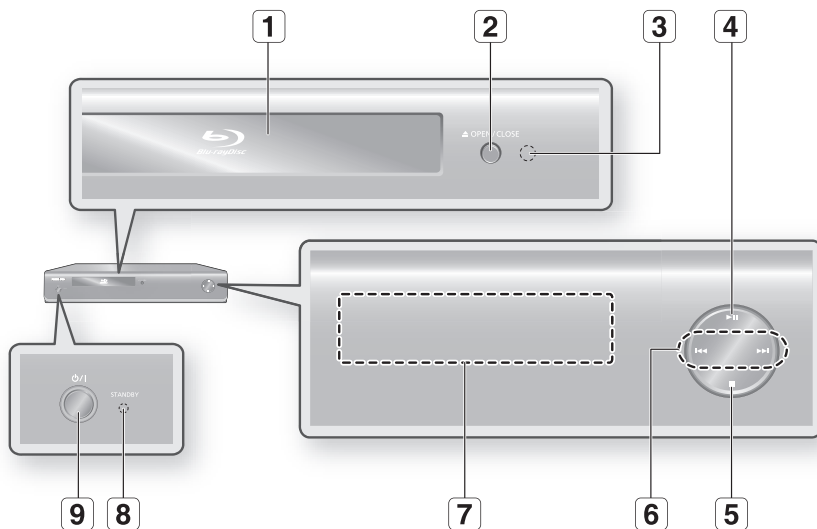

1	DISC TRAY	Opens to accept a disc.
2	OPEN/CLOSE BUTTON	Opens and closes the disc tray.
3	Remote Control Sensor	
4	PLAY/PAUSE BUTTON	Plays a disc or pauses playback.
5	STOP BUTTON	Stops disc playback.
6	SEARCH/SKIP BUTTONS	Goes to the next title/chapter/track or goes back to the previous title/chapter/track.
7	DISPLAY	Displays the playing status, time, etc.
8	STANDBY INDICATOR	When the unit is first plugged in, this indicator lights.
9	POWER BUTTON	Turns the Blu-ray Disc Player on and off.

FRONT PANEL DISPLAY

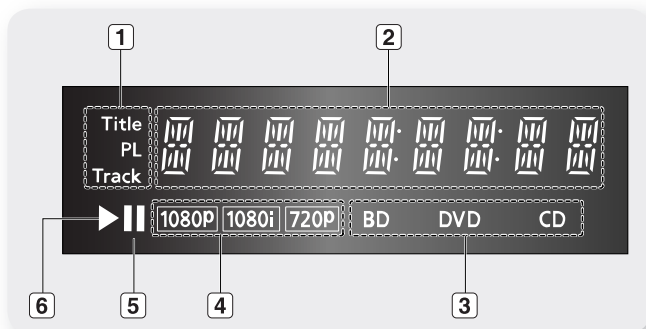

1	Title/PlayList/Track indicator.
2	Playing time/clock/current status indicator.
3	Disc type indicators.
4	Video output resolution indicator.
5	Pause indicator.
6	Playback indicator.

REAR PANEL

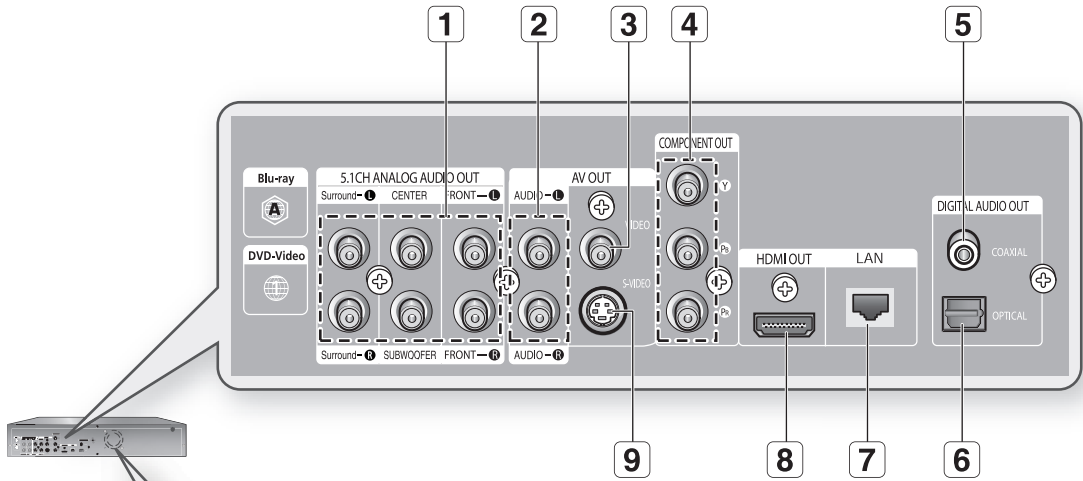



Fan
The fan always revolves when the power is on. Ensure a minimum of 4 inches of clear space on all sides of the fan when installing the product.

1	5.1CH ANALOG AUDIO OUT	Connect to a 5.1CH analog input on an A/V amplifier
2	AUDIO OUT	Connects to the audio input of external equipment using audio cables.
3	VIDEO OUT	Connects the input of external equipment using a video cable.
4	COMPONENT VIDEO OUT	Connects to equipment having Component video input.
5	DIGITAL AUDIO OUT (COAXIAL)	Connects to an amplifier having a digital coaxial audio input jack.
6	DIGITAL AUDIO OUT (OPTICAL)	Connects to an amplifier having a digital optical audio input jack.
7	LAN	Connect this LAN terminal to the LAN terminal on your modem for software upgrades.
8	HDMI OUT	Use the HDMI cable, connect this HDMI output terminal to the HDMI input terminal on your TV for the best quality picture.
9	S-VIDEO OUT	Connects the input of external equipment using an S-Video cable.

remote control

TOUR OF THE REMOTE CONTROL

Installing batteries in the Remote Control

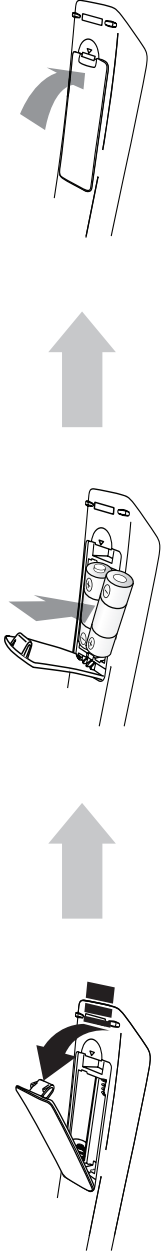

- 1. Lift the cover at the back of the remote control upward as shown.**
To open and close the disc tray.
- 2. Install two AAA size batteries.**
Make sure to match the "+" and "-" ends of the batteries with the diagram inside the compartment.
- 3. Replace the cover.**
Assuming typical TV usage, the batteries last for about one year.

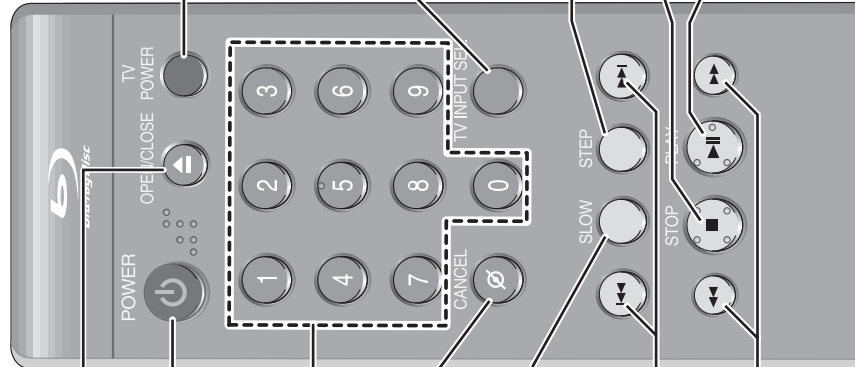

OPEN/CLOSE Buttons
To open and close the disc tray.

POWER Button

NUMBER Buttons

CANCEL Button

SLOW Button
Each time this button is pressed, the disc will play slowly.

REVERSE/FORWARD SKIP Buttons
Press to skip backwards or forwards.

REVERSE/FORWARD SEARCH Buttons
Press to search a disc backwards or forwards.

TV POWER Button

TV INPUT SEL. Button
After setup, allows you to set the input source on your TV. When the TV INPUT SEL. button is selected on the remote control, the DIRECTION (up/down/left/right) and ENTER buttons operate your TV's menu screen, but not the player. To enable the button operation for the player, press the RETURN button.

STEP Button
Each time this button is pressed, a new frame will appear.

STOP Button
Press to stop a disc.

PLAY/PAUSE Button
Press to play/pause a disc.

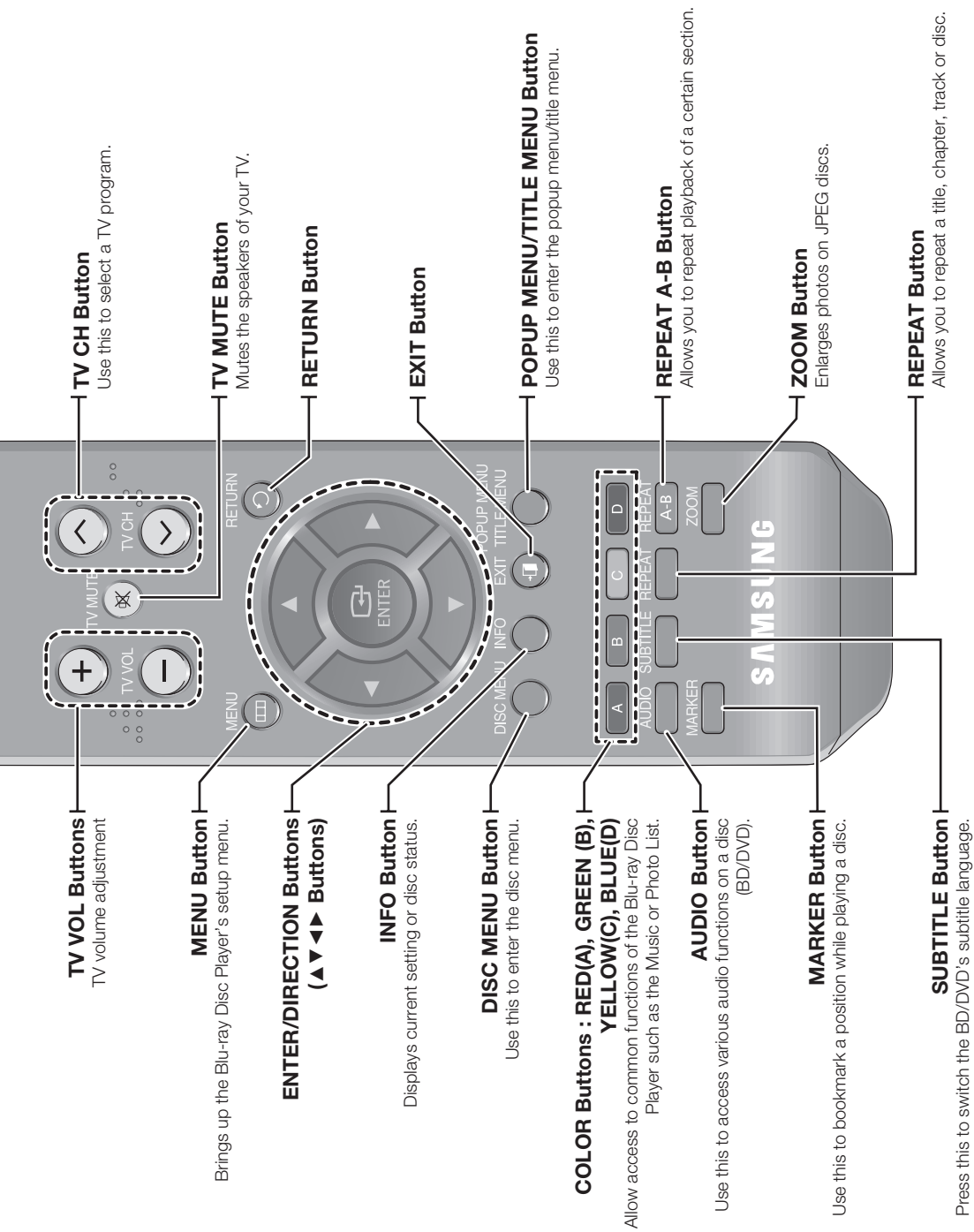

remote control

SETTING THE REMOTE CONTROL

You can control certain functions of your TV with this remote control.

Control function buttons include : **TV POWER**, **TV CH $\wedge \vee$** , **TV VOL + -**, **TV MUTE**, **TV INPUT SEL.**.

To determine whether your television is compatible, follow the instructions below.

1. Switch your television on.
2. Point the remote control towards the television.
3. Press and hold the **TV POWER** button and enter the two-figure code corresponding to the brand of your television, by pressing the appropriate number buttons. (see the next page for the code list).
If your television is compatible with the remote control, it will switch off.
It is now programmed to operate with the remote control.

- ✍ If several codes are indicated for your television brand, try each one in turn until you find one that works.
- ✍ If you replace the remote control's batteries, you must set the brand code again.

You can then control the television using the following buttons after pressing the TV button.

Button	Function
TV POWER	Used to switch the television on and off.
TV INPUT SEL.	Used to select an external source.
TV VOL (+ -)	Used to adjust the volume of the television.
TV CH ($\wedge \vee$)	Used to select the desired channel.
TV MUTE	Used to toggle the sound on and off.

- ✍ The functions listed above will not necessarily work on all televisions. If you encounter problems, operate the television directly.

REGARDING THE BATTERY

If the remote does not operate properly:

- Check the polarity + - of the batteries (Dry-Cell)
- Check if the batteries are drained.
- Check if remote sensor is blocked by obstacles.
- Check if there is any fluorescent lighting nearby.

Dispose of batteries according to local environmental regulations. Do not put them in the household trash.

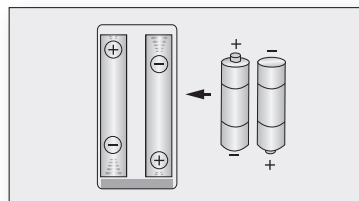

CONTROLLABLE TV CODES

Brand	Code
SAMSUNG	TV POWER+01, +02, +03, +04, +05, +06, +07, +08, +09
AIWA	TV POWER+82
ANAM	TV POWER+10, +11, +12, +13, +14, +15, +16, +17, +18
BANG & OLUFSEN	TV POWER+57
BLAUPUNKT	TV POWER+71
BRANDT	TV POWER+73
BRIONVEGA	TV POWER+57
CGE	TV POWER+52
CONTINENTAL EDISON	TV POWER+75
DAEWOO	TV POWER+19, +20, +23, +24, +25, +26, +27, +28, +29, +30, +31, +32, +33, +34
EMERSON	TV POWER+64
FERGUSON	TV POWER+73
FINLUX	TV POWER+06, +49, +57
FORMENTI	TV POWER+57
FUJITSU	TV POWER+84
GRADIENTE	TV POWER+70
GRUNDIG	TV POWER+49, +52, +71
HITACHI	TV POWER+60, +72, +73, +75
IMPERIAL	TV POWER+52
JVC	TV POWER+61, +79
LG	TV POWER+06, +19, +20, +21, +22, +78
LOEWE	TV POWER+06, +69
LOEWE OPTA	TV POWER+06, +57
MAGNAVOX	TV POWER+40
METZ	TV POWER+57
MITSUBISHI	TV POWER+06, +48, +62, +65
MIVAR	TV POWER+52, +77
NEC	TV POWER+83
NEWSAN	TV POWER+68
NOBLEX	TV POWER+66
NOKIA	TV POWER+74
NORDMENDE	TV POWER+72, +73, +75
PANASONIC	TV POWER+53, +54, +74, +75
PHILIPS	TV POWER+06, +55, +56, +57
PHONOLA	TV POWER+06, +56, +57
PIONEER	TV POWER+58, +59, +73, +74
RADIOLA	TV POWER+06, +56
RADIOMARELLI	TV POWER+57
RCA	TV POWER+45, +46
REX	TV POWER+74
SABA	TV POWER+57, +72, +73, +74, +75
SALORA	TV POWER+74
SANYO	TV POWER+41, +42, +43, +44, +48
SCHNEIDER	TV POWER+06
SELECO	TV POWER+74
SHARP	TV POWER+36, +37, +38, +39, +48
SIEMENS	TV POWER+71
SINGER	TV POWER+57
SINUDYNE	TV POWER+57
SONY	TV POWER+35, +48
TELEAVA	TV POWER+73
TELEFUNKEN	TV POWER+67, +73, +75, +76
THOMSON	TV POWER+72, +73, +75
THOMSON ASIA	TV POWER+80, +81
TOSHIBA	TV POWER+47, +48, +49, +50, +51, +52
WEGA	TV POWER+57
YOKO	TV POWER+06
ZENITH	TV POWER+63

connections

This section involves various methods of connecting the Blu-ray Disc Player to other external components.

CONNECTING TO A TV WITH AN HDMI CABLE

1. Using an HDMI-HDMI cable (not included) connect the **HDMI OUT** terminal on the rear of the Blu-ray Disc Player to the **HDMI IN** terminal of your TV.
2. Press the input selector on your TV remote control until the HDMI signal from the Blu-ray Disc Player appears on your TV screen.
 - If you have set the remote control to properly operate with your TV (see pages 18~19), press the **TV INPUT SEL.** button on the remote control and select HDMI as the external source of the TV.

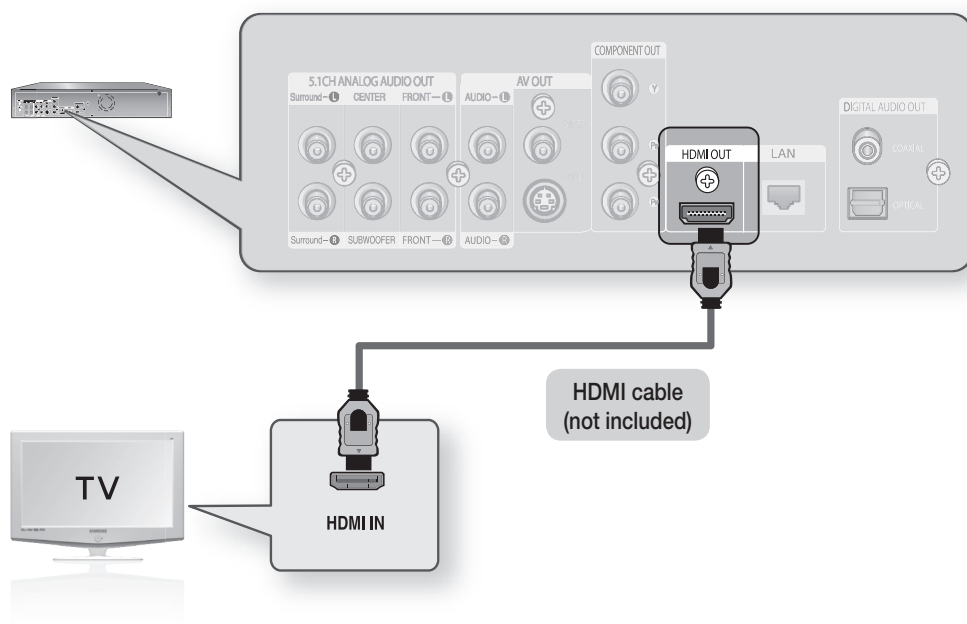

- If the HDMI cable is connected or removed during playback of a CDDA, MP3 or JPEG file, the player will stop playing.

HDMI AUTO DETECTION FUNCTION

The player's video output will automatically change to HDMI mode when connecting an HDMI cable while power is on (see page 40).



- Depending on your TV, certain HDMI output resolutions may not work.
- Please refer to the user's manual of your TV.
- If an HDMI or HDMI-DVI cable is connected from the player to a TV, the Blu-ray Disc Player's output is set to HDMI/DVI automatically within 10 seconds.
- If Component and HDMI are both connected, HDMI mode is automatically selected. (See page 40)
- When you connect the player to the TV using the HDMI cable for the first time or to a new TV, the HDMI output resolution will be automatically set to the highest provided by the TV.
- If you connect a Samsung TV to the Blu-ray Disc Player using an HDMI cable, the player can be easily operated using the TV remote control. (This is only available with Samsung TVs that support the Anynet+ feature.) (See pages 41~42)

• HDMI (High Definition Multimedia Interface)

HDMI is an interface that enables the digital transmission of video and audio data with just a single connector.

Using HDMI, the Blu-ray Disc Player transmits a digital video and audio signal and displays a vivid picture on a TV having an HDMI input jack.

• HDMI connection description

HDMI connector - Supports video and digital audio data (LPCM or Bitstream).

- HDMI outputs only a pure digital signal to the TV.

- If your TV does not support HDCP (High-bandwidth Digital Content Protection), random noise appears on the screen.

• Why does Samsung use HDMI?

Analog TVs require an analog video/audio signal. However, when playing a BD/DVD, the data transmitted to a TV is digital. Therefore either a digital-to-analog converter (in the Blu-ray Disc Player) or an analog-to-digital converter (in the TV) is required. During this conversion, the picture quality is degraded due to noise and signal loss. HDMI technology is superior because it requires no D/A conversion and is a pure digital signal from the player to your TV.

• What is the HDCP?

HDCP (High-band width Digital Content Protection) is a system for protecting BD/DVD content outputted via HDMI from being copied. It provides a secure digital link between a video source (PC, DVD, etc) and a display device (TV, projector, etc). Content is encrypted at the source device to prevent unauthorized copies from being made.

• What is Anynet+?

Anynet+ is a convenient function that offers linked operation of this unit through Samsung TVs with the Anynet+ feature.

- If your Samsung TV has an **Anynet+** logo, then it supports Anynet+ function.

- If you turn on the player and insert a disc, the player will start playing the disc, and the TV will turn on automatically and switch to HDMI mode.

- If you turn on the player and press the Play button with a disc already inserted, the TV will immediately turn on and switch to HDMI mode.

connections

CONNECTING TO A TV WITH DVI CABLE

1. Using the HDMI-DVI cable (not included), connect the **HDMI OUT** terminal on the rear of the Blu-ray Disc Player to the **DVI IN** terminal of your TV.
2. Using the audio cables, connect the **AUDIO (red and white) OUT** terminals on the rear of the Blu-ray Disc Player to the **AUDIO (red and white) IN** terminals of your TV.
Turn on the Blu-ray Disc Player and TV.
3. Press the input selector on your TV remote control until the DVI signal from the Blu-ray Disc Player appears on your TV screen.
 - If you have set the remote control to properly operate with your TV (see pages 18~19), press the **TV INPUT SEL.** button on the remote control and select HDMI as the external source of the TV.

Connecting the HDMI cable while the Blu-ray player's power is on, the player's video output will automatically change to HDMI mode (see page 40).



- Depending on your TV, certain HDMI output resolutions may not work.
- Please refer to the user's manual of your TV.
- If an HDMI or HDMI-DVI cable is plugged into TV, the Blu-ray Disc Player's output is set to HDMI/DVI automatically within 10 seconds.
- If Component and HDMI are both connected, HDMI mode is automatically selected. (See page 40)
- When you connect the player to the TV using the HDMI cable for the first time or to a new TV, the HDMI output resolution will be automatically set to the highest provided by the TV
- If the HDMI cable is connected or removed during playback of a CDDA, MP3 or JPEG file, the player will stop playing.

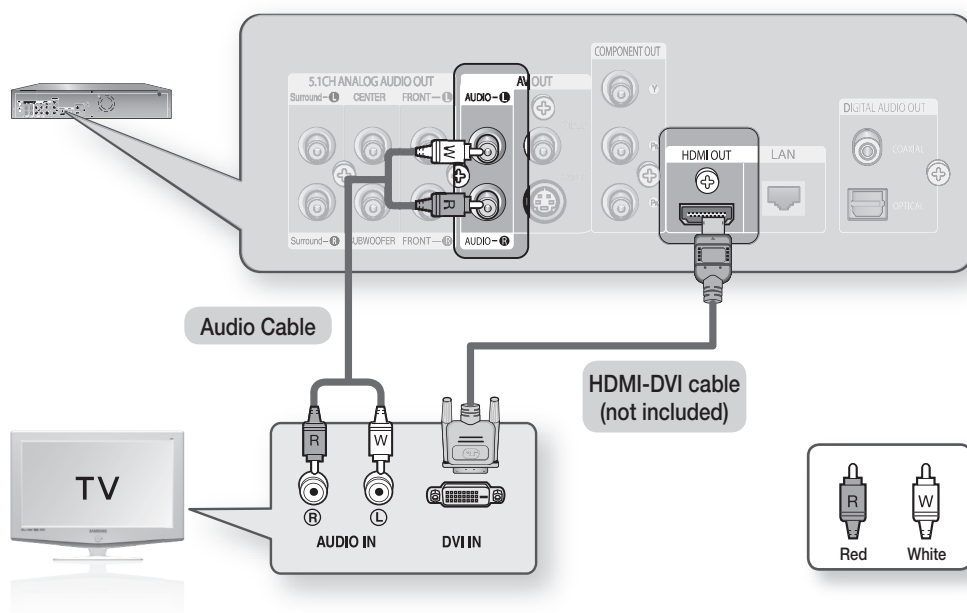

CONNECTING TO A TV (COMPONENT)

Connecting to your TV using Component video cables.

You will enjoy high quality and accurate color reproduction images. Component video separates the picture element into black and white(Y), blue(Pb), red(Pr) signals to present clear and clean images. (Audio signals are delivered through the audio output.)

1. Using component video cables (not included), connect the **COMPONENT VIDEO OUT** terminals on the rear of the Blu-ray Disc Player to the **COMPONENT IN** terminals of your TV.
2. Using the audio cables (not included), connect the **AUDIO (red and white) OUT** terminals on the rear of the Blu-ray Disc Player to the **AUDIO (red and white) IN** terminals of your TV. Turn on the Blu-ray Disc Player and TV.
3. Press the input selector on your TV remote control until the Component signal from the Blu-ray Disc Player appears on the TV screen.
 - If you have set the remote control to properly operate with your TV (see pages 18~19), press the **TV INPUT SEL.** button on the remote control and select COMPONENT as the external source of the TV.

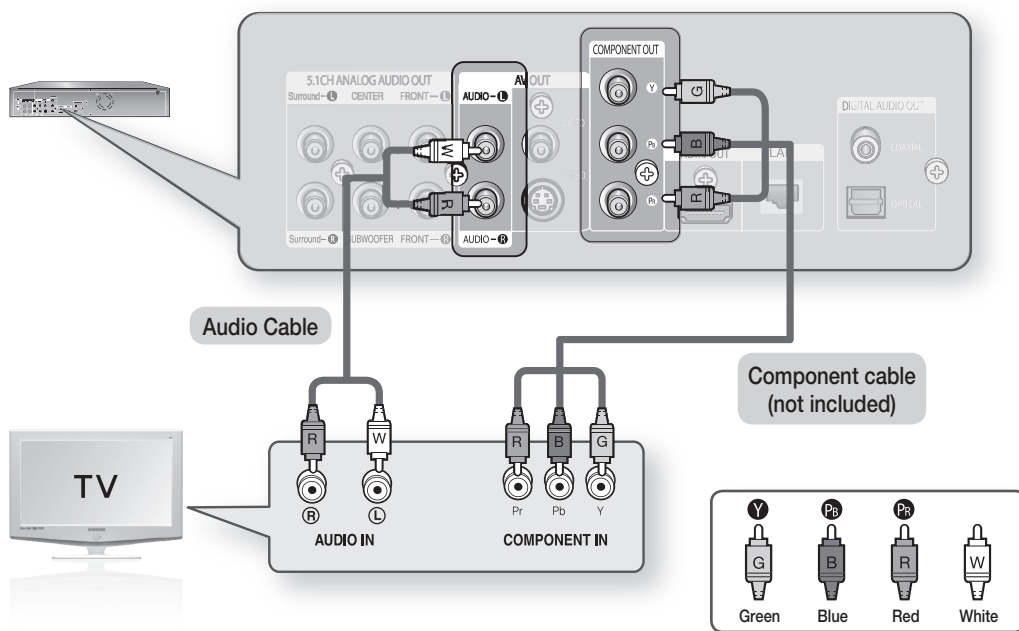

- Depending on the manufacturer, the component terminals on your TV may be marked "R-Y, B-Y, Y" or "Cr, Cb, Y" instead of "Pr, Pb, Y". The number and position of terminals may vary depending on the TV set. Please refer to the user's manual of your TV.
- You can select from a variety of resolution settings such as 1080i, 720p, 480p and 480i, depending on the disc type. (See page 40)
- The actual resolution may differ from the setting in the SETUP menu if both Component and HDMI cables are connected. The resolution may also be different depending on the disc. (See page 40)

connections

CONNECTING TO A TV (S-VIDEO)

Connecting to your TV using an S-Video cable.

You will enjoy high quality images. S-Video separates the picture element into black and white(Y) and color(C) signals to present clearer images than regular video input mode.

(Audio signals are delivered through the audio output.)

1. Using an S-Video cable (not included), connect the **S-VIDEO OUT** terminal on the rear of the Blu-ray Disc Player to the **S-VIDEO IN** terminal of your TV.
2. Using the audio cables, connect the **AUDIO (red and white) OUT** terminals on the rear of the Blu-ray Disc Player to the **AUDIO (red and white) IN** terminals of your TV. Turn on the Blu-ray Disc Player and TV.
3. Press the input selector on your TV remote control until the S-Video signal from the Blu-ray Disc Player appears on your TV screen.
 - If you have set the remote control to properly operate with your TV (see pages 18–19), press the **TV INPUT SEL.** button on the remote control and select S-VIDEO as the external source of the TV.

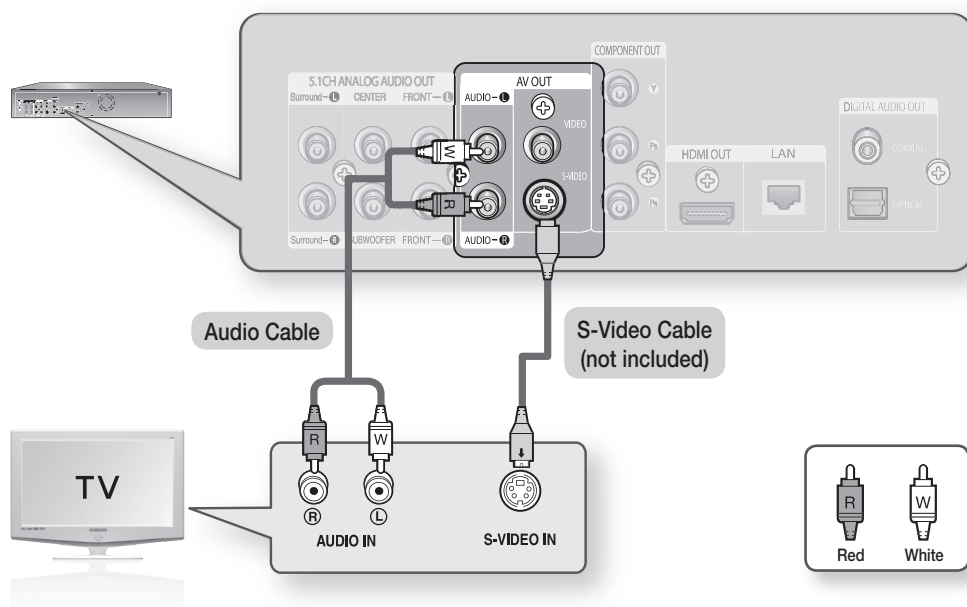

- The S-VIDEO source is always output in 480i resolution regardless of the set resolution in the SETUP menu. (See page 40)

CONNECTING TO A TV(VIDEO)

1. Using video/audio cables, connect the **VIDEO (yellow) / AUDIO (red and white) OUT** terminals on the rear of the Blu-ray Disc Player to the **VIDEO (yellow) / AUDIO (red and white) IN** terminals of your TV.
2. Turn on the Blu-ray Disc Player and TV.
3. Press the input selector on your TV remote control until the Video signal from the Blu-ray Disc Player appears on the TV screen.
 - If you have set the remote control to properly operate with your TV (see pages 18~19), press the **TV INPUT SEL.** button on the remote control and select VIDEO as the external source of the TV.

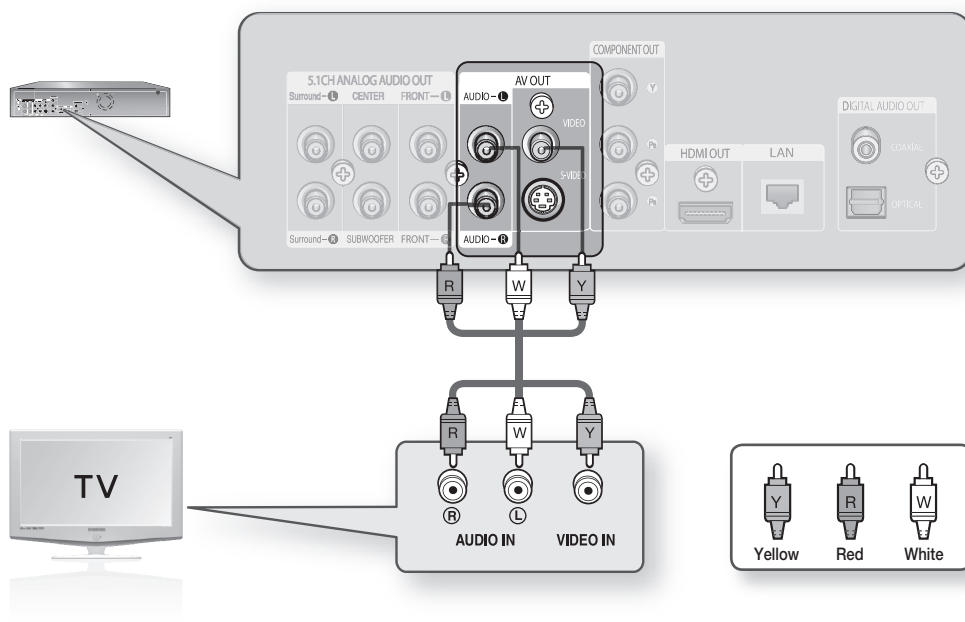

- Noise may be generated if the audio cable placed too close to the power cable.
- If you want to connect to an Amplifier, please refer to the Amplifier connection pages. (See pages 26~29)
- The number and position of terminals may vary depending on your TV set. Please refer to the user's manual of your TV.
- If there is one audio input terminal on the TV, connect it to the [AUDIO OUT][left] (white) terminal of the Blu-ray Disc Player.
- The VIDEO source is always output in 480i resolution regardless of the set resolution in the SETUP menu. (See page 40)

connections

CONNECTING TO AN AUDIO SYSTEM (2 CHANNEL AMPLIFIER)

1. Using the audio cables, connect the **AUDIO (red and white) OUT** terminals on the rear of the Blu-ray Disc Player to the **AUDIO (red and white) IN** terminals of your Amplifier.
2. Using the video signal cable(s), connect the **HDMI, COMPONENT, S-VIDEO, or VIDEO OUT** terminals on the rear of the Blu-ray Disc Player to the **HDMI, COMPONENT, S-VIDEO, or VIDEO IN** terminal of your TV as described on pages 20 to 25.
3. Turn on the Blu-ray Disc Player, TV and Amplifier.
4. Press the input select button of the Amplifier to select the **external input** in order to hear sound from the Blu-ray Disc Player. Refer to your Amplifier's user manual to set the Amplifier's audio input.

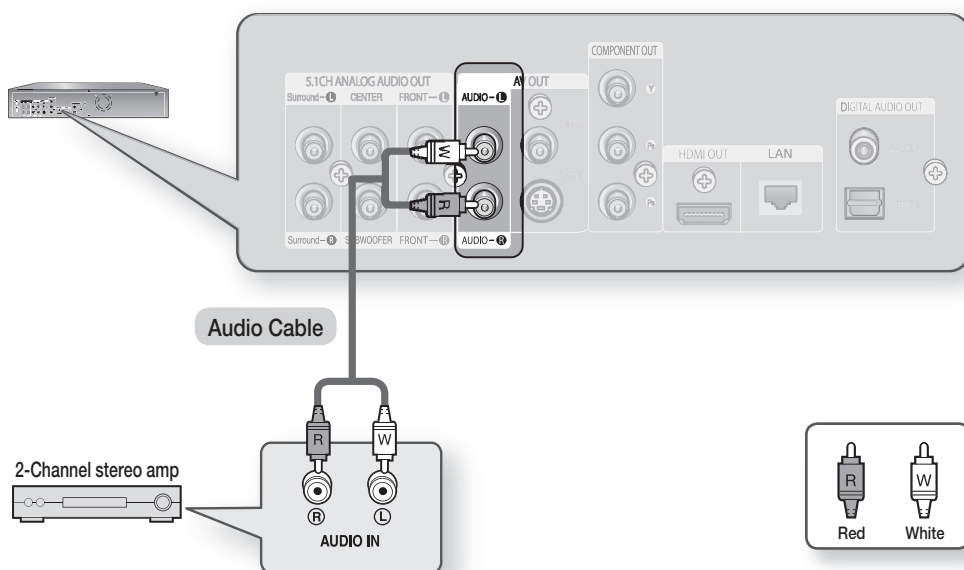

- Manufactured under license from Dolby Laboratories. "Dolby" and the double-D symbol are trademarks of Dolby Laboratories.
- "DTS" and "DTS Digital Surround" are registered trademarks of DTS, Inc.

CONNECTING TO AN AUDIO SYSTEM (5.1 CHANNEL AMPLIFIER)

1. Using the audio cables, connect the **5.1 ANALOG AUDIO OUT (Front R, Front L, CENTER, SUBWOOFER, Surround L, Surround R)** terminals on the rear of the Blu-ray Disc Player to the **5.1 Channel ANALOG AUDIO IN (Front R, Front L, CENTER, SUBWOOFER, Surround L, Surround R)** terminals of your Amplifier.
2. Using the video signal cable(s), connect the **HDMI, COMPONENT, S-VIDEO, or VIDEO OUT** terminals on the rear of the Blu-ray Disc Player to the **HDMI, COMPONENT, S-VIDEO, or VIDEO IN** terminal of your TV as described on pages 20 to 25.
3. Turn on the Blu-ray Disc Player, TV and Amplifier.
4. Press the input select button of the Amplifier to select **external input** in order to hear sound from the Blu-ray Disc Player. Refer to your Amplifier's user manual to set the Amplifier's audio input.

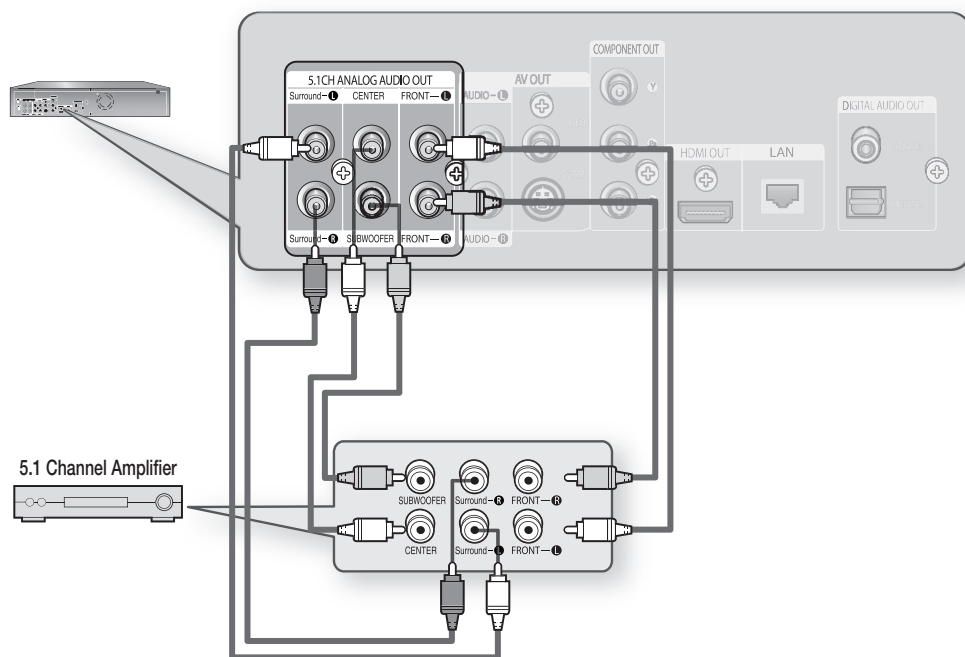

- Please turn the volume down when you turn on the Amplifier. Sudden loud sound may cause damage to the speakers and your ears.
- Please set the audio in the menu screen according to the Amplifier. (See pages 35~36)
- The position of terminals may vary depending on the Amplifier. Please refer to the user's manual of your Amplifier.
- The front left and right outputs on your player and 5.1 channel amplifier must be connected to hear disc menu audio from certain Blu-Ray discs.

connections

CONNECTING TO AN AUDIO SYSTEM (DOLBY DIGITAL, DTS AMPLIFIER)

1. If using an optical cable (not included), connect the **DIGITAL AUDIO OUT (OPTICAL)** terminal on the rear of the Blu-ray Disc Player to the **DIGITAL AUDIO IN (OPTICAL)** terminal of your Amplifier.
If using a coaxial cable (not included), connect the **DIGITAL AUDIO OUT (COAXIAL)** terminal on the rear of the Blu-ray Disc Player to the **DIGITAL AUDIO IN (COAXIAL)** terminal of the Amplifier.
2. Using the video signal cable(s), connect the **HDMI**, **COMPONENT**, **S-VIDEO**, or **VIDEO OUT** terminals on the rear of the Blu-ray Disc Player to the **HDMI**, **COMPONENT**, **S-VIDEO**, or **VIDEO IN** terminals of your TV as described on pages 20 to 25.
3. Turn on the Blu-ray Disc Player, TV, and Amplifier.
4. Press the input select button of the Amplifier to select the **external input** in order to hear sound from the Blu-ray Disc Player. Refer to your Amplifier's user manual to set the Amplifier's audio input.

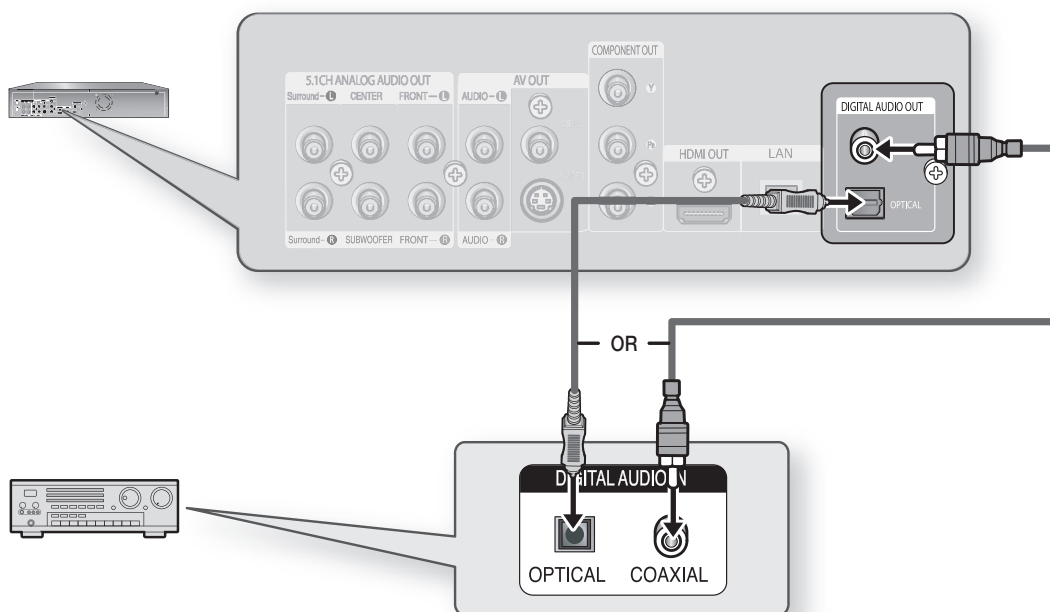

- Please turn the volume down when you turn on the Amplifier. Sudden loud sound may cause damage to the speakers and your ears.
- Please set the audio in the menu screen according to the Amplifier. (See pages 35~36)
- The position of terminals may vary depending on the Amplifier. Please refer to the user's manual of your Amplifier.
- When using this connection, Blu-ray Discs with an LPCM audio soundtrack will only be heard over the front two channels.

CONNECTING TO AN AUDIO SYSTEM (HDMI SUPPORTED AMPLIFIER)

1. Using the HDMI-HDMI cable (not included), connect the **HDMI OUT** terminal on the rear of the Blu-ray Disc Player to the **HDMI IN** terminal of your Amplifier.
2. Using the HDMI-HDMI cable, connect the **HDMI OUT** terminal of the Amplifier to the **HDMI IN** terminal of your TV.
3. Turn on the Blu-ray Disc Player, TV, and Amplifier.
4. Press the input select button of the Amplifier to select **external input** in order to hear sound from the Blu-ray Disc Player. Refer to your Amplifier's user manual to set the Amplifier's audio input.

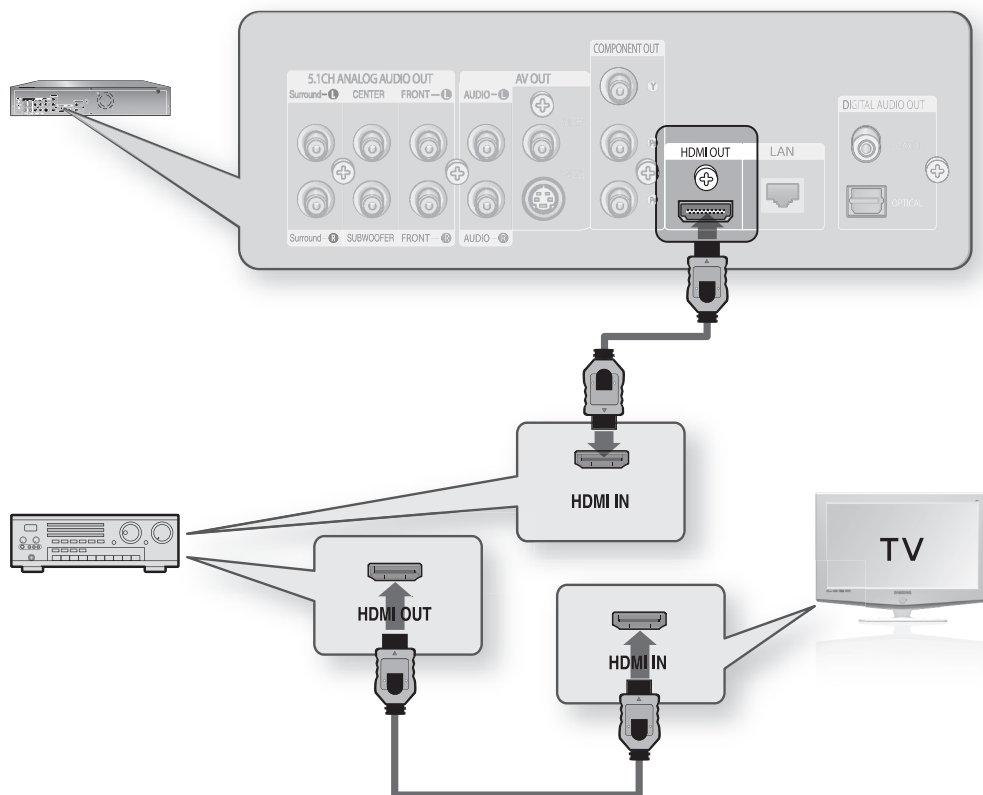

- Please turn the volume down when you turn on the Amplifier. Sudden loud sound may cause damage to the speakers and your ears.
- Please set the audio in the menu screen according to the Amplifier. (See pages 35~36)
- The position of terminals may vary depending on the Amplifier. Please refer to the user's manual of your Amplifier.

connections

CONNECTING TO SAMSUNG'S FTP/INTERNET SITE FOR SOFTWARE UPGRADES

1. Using the Direct LAN Cable (UTP cable), connect the LAN terminal on the rear of the Blu-ray Disc Player to the LAN terminal of your modem.
 - Connect to the Internet for future software upgrades.

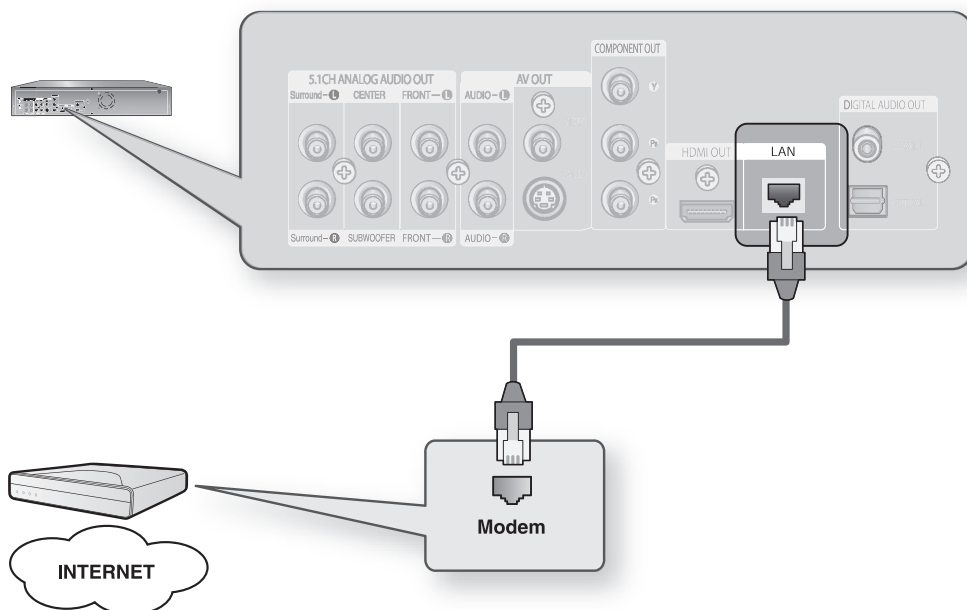

 ■ See pages 45~48 for the Software Upgrade procedure.

basic functions of your Blu-ray Disc Player

This section introduces basic playback functions and playback by disc type.

BEFORE PLAYING

- Turn on your TV and set it to the correct Video Input (the input the Blu-ray player is connected to).
- If you connected an external Audio System, turn on your Audio System and set it to the correct Audio Input.

After plugging in the player, the first time you press the **POWER** button, this screen comes up:

If you want to select a language, press a **NUMBER** button. (This screen will only appear when you plug in the player for the first time.) If the language for the startup screen is not set, the settings may change whenever you turn the power on or off. Therefore, make sure that you select the language you want to use. Once you select a menu language, you can change it by pressing the **▶▶** button on the front panel of the unit for more than 5 seconds with no disc in the unit. Then the MENU LANGUAGE SELECTION window appears again where you can reset your preferred language.

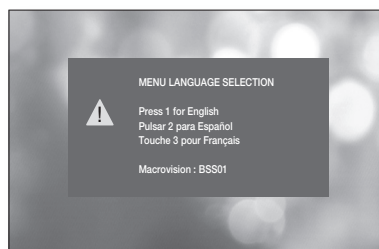

- Discs which cannot be played on this player.
 - BD-R
 - BD-RE
 - HD DVD
 - DVD+RW
 - DVD+R
 - DVD-ROM
 - DVD-RAM
 - CDV
 - CD-ROM
 - CVD
 - CD-I
 - Super Audio CD(except CD layer)
 - CDGs play audio only, not graphics.
- Ability to play back may depend on recording conditions.
 - DVD-R
 - CD-RW/R
 - DVD-RW (V mode)
 - The unit may not play certain CD-R, CD-RW and DVD-R due to the disc type or recording conditions.
- Blu-ray Disc is a new and evolving format. Accordingly, disc compatibility issues with new and existing format discs are possible. Not all discs are compatible and not every disc will playback. For additional information, refer to the Disc Type and Characteristics and Compliance and Compatibility Notice sections of this Manual. If you encounter compatibility problems, please contact SAMSUNG customer care center.
- The unit cannot play CD-R/-RW and DVD-RW/-R recorded content such as divx, avi, mpg, mov, wma.

basic functions of your Blu-ray Disc Player

ON-SCREEN MENU NAVIGATION

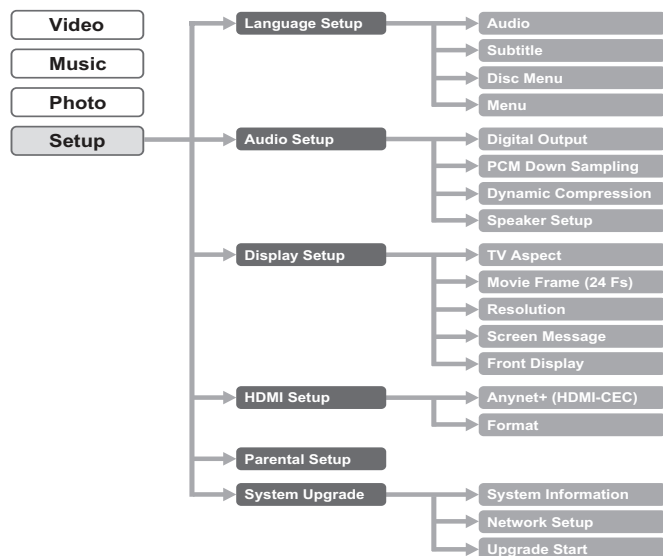

PLAYING A DISC

1. Press the **OPEN/CLOSE** (⏏) button.
The **STANDBY** indicator light goes out and the tray opens.
2. Place a disc gently into the tray with the disc's label facing up.
3. Press the **PLAY/PAUSE** (⏮) button or **OPEN/CLOSE** (⏏) button to close the disc tray.



- When you stop disc play, the player remembers where you stopped, so when you press **PLAY/PAUSE** (⏮) button again, it will pick up where you left off.
- Press the **STOP** (⏏) button twice during playback to disable the Resume function.
- To pause the playback, press the **PLAY/PAUSE** (⏮) button during playback. To resume, press the **PLAY/PAUSE** (⏮) button once again.
- If the player is left in the stop mode for more than 10 minutes without any user interface, a screen saver will appear on your TV. If the player is left in the screen saver mode for more than 30 minutes, the power will automatically turn off except during playback of an MP3/CDDA and/or JPEG. (Automatic Power-Off Function)
- MP3/CDDA : if no button is pressed for more than 10 minutes, the screen saver appears.
- JPEG : the screen saver program or the auto power off function will be deactivated when playing a photo file.

USING THE SEARCH AND SKIP FUNCTIONS

During play, you can search quickly through a chapter or track, and use the skip function to jump to the next selection.

Searching through a Chapter or Track



During playback, press the **SEARCH** (⏪ ⏩) button.

- If you want to search at a faster speed on the BD/DVD, press this button.
- If you press the **SEARCH** (⏩) button,
▶▶ X2 ▶▶ X4 ▶▶ X8 ▶▶ X16 ▶▶ X32 ▶▶ X128
- If you press the **SEARCH** (⏪) button,
◀◀ X2 ◀◀ X4 ◀◀ X8 ◀◀ X16 ◀◀ X32 ◀◀ X128



- No sound is heard during search mode.

Skipping Tracks



During playback, press the **SKIP** (⏮ ⏭) button.

When playing a BD/DVD, if you press the **SKIP** (⏭) button, it moves to the next chapter. If you press the **SKIP** (⏮) button, it moves to the beginning of the chapter. One more press makes it move to the beginning of the previous chapter.

SLOW MOTION PLAY/STEP MOTION PLAY

Slow Motion Play



In pause or step mode, press the **SLOW** button on the remote control for Slow Motion play.

- If you press the **SLOW** button, ▶ 8/1 ▶ 4/1 ▶ 2/1
- To return to normal speed playback, press the **PLAY/PAUSE** (⏮) button.



- This (⊘) icon indicates an invalid button press.
- No sound is heard during slow mode.
- Slow motion operates only in the forward direction.

Step Motion Play



Press the **STEP** button on the remote control during play for Step Motion play.

- Each time the button is pressed a new frame will appear.
- When the **STEP** button is pressed, the next frame will be activated.
- Press the **PLAY/PAUSE** (⏮) button to resume normal play.



- No sound is heard during step mode.
- Step motion operates only in the forward direction.

system setup

For your convenience, configure proper settings for the external device to connect or any other environment before using the player.

SETTING UP THE LANGUAGE OPTIONS

If you set the audio, subtitle, disc menu and player menu, in advance, they will come up automatically every time you watch a movie.

1. With the unit in Stop mode, press the **MENU** button.
2. Press the **▲▼** buttons to select **Setup**, then press the **ENTER** or **▶** button.

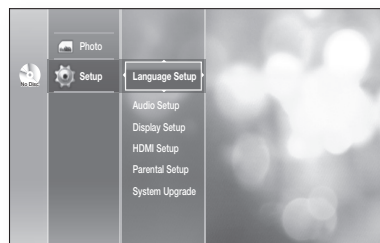

3. Press the **▲▼** buttons to select **Language Setup**, then press the **ENTER** or **▶** button. Language setup menu will be displayed.



4. Press the **▲▼** buttons to select the desired language option, press the **ENTER** or **▶** button.
 - **Audio** : For the disc audio language.
 - **Subtitle** : For the disc subtitles.
 - **Disc Menu** : For the disc menu contained on the disc.
 - **Menu** : For the on-screen menu of your Blu-ray Disc Player.

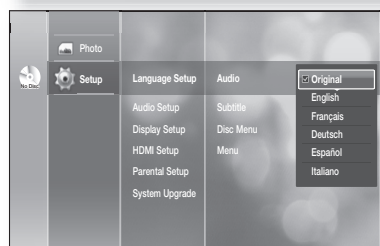

5. Press the **▲▼** buttons to select the desired language, then press the **ENTER** button.



- Press the **RETURN** or **◀** button to return to the previous menu. Press the **MENU** button to exit the menu.
- The selected language will only appear if it is supported on the disc.

SETTING UP THE AUDIO OPTIONS

Allows you to set up the Audio device and sound status depending on the audio system being used with the player.

1. With the unit in Stop mode, press the **MENU** button.
2. Press the **▲▼** buttons to select **Setup**, then press the **ENTER** or **▶** button.
3. Press the **▲▼** buttons to select **Audio Setup**, then press the **ENTER** or **▶** button.

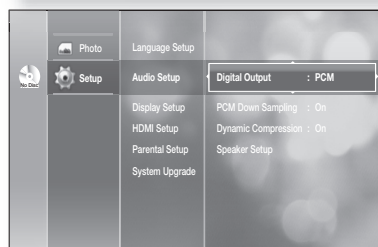
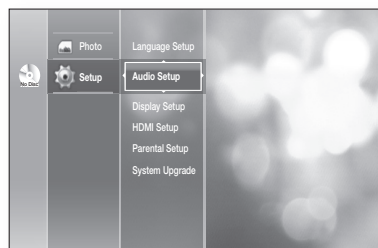

4. Press the **▲▼** buttons to select the desired audio option from the options described below, then press the **ENTER** or **▶** button.
5. Press the **▲▼** buttons to select the desired item, then press the **ENTER** button.



- Press the **RETURN** or **◀** button to return to the previous menu.
Press the **MENU** button to exit the menu.

Digital Output

- **PCM** : Select this when your equipment does not decode Dolby Digital.
- **Bitstream** : Outputs Dolby Digital or DTS audio as Bitstream. Select this when your AV receiver or AV amplifier has a Dolby Digital or DTS Decoder.

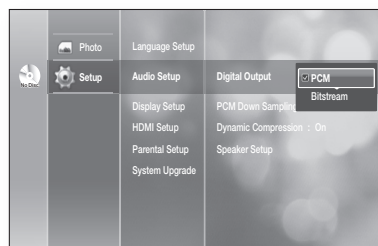



- If you have selected a LPCM sound track on a disc, the output will automatically be set to PCM.
- Be sure to select the correct Digital Output or you will hear no sound or a loud noise.
- When playing a Dolby Digital movie make sure the Digital Output is set to Bitstream.
- If the HDMI device (Receiver, TV) is not compatible with compressed formats (Dolby digital, DTS), The audio signal outputs as PCM.

system setup

PCM Down Sampling

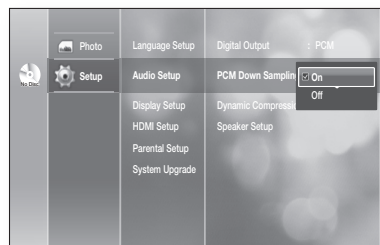
- **On** : Select this when the Amplifier connected to the player is not 96KHz compatible. 96KHz signals will be down converted to 48KHz
- **Off** : Select this when the Amplifier connected to the player is 96KHz compatible. Signals will be output without any changes.



-
-  Even when PCM Down Sampling is set to Off, some discs will only output downsampled audio through the coaxial and optical digital outputs.

HDMI

- If your TV is not compatible with compressed multi-channel formats (Dolby Digital, DTS), you should set Digital Audio to PCM.
- If your TV is not compatible with LPCM sampling rates over 48kHz, you should set PCM Down Sampling to On.

Dynamic Compression

This is only active when a Dolby Digital signal is detected.

- **Off** : You can enjoy the movie with the standard Dynamic Range.
- **On** : When Movie soundtracks are played at low volume or from smaller speakers, the system can apply appropriate compression to make low-level content more intelligible and prevent dramatic passages from getting too loud.

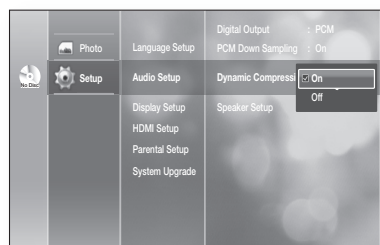

SETTING UP THE SPEAKER OPTIONS

If you have connected this player to an Amp/Receiver or Home theater via the 5.1 channel Analog outputs you need to set the Speaker Options for the best sound.

1. With the unit in Stop mode, press the **MENU** button.
2. Press the **▲▼** buttons to select **Setup**, then press the **ENTER** or **▶** button.
3. Press the **▲▼** buttons to select **Audio Setup**, then press the **ENTER** or **▶** button.
4. Press the **▲▼** buttons to select **Speaker Setup**, then press the **ENTER** or **▶** button.
5. Press the **▲▼◀▶** buttons to select the desired Speaker, then press the **ENTER** button.
6. When done, use the **▲▼◀▶** buttons to select **Save**, then press the **ENTER** button.
If you don't want to save your work, use the **▲▼◀▶** buttons to select **Cancel**, then press the **ENTER** button.

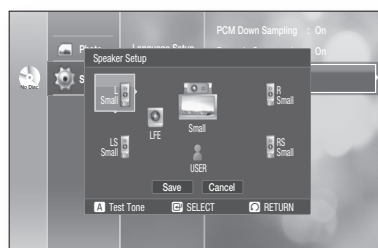
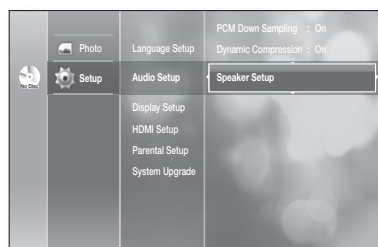
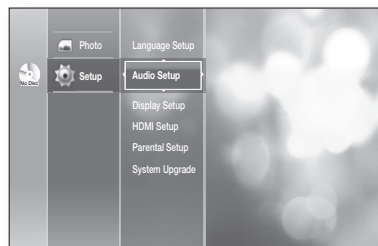

- Press the **RETURN** or **◀** button to return to the previous menu.

Speaker Setup

Front (L, R)	Large, Small
Center (C)	Large, Small, None
Surround (LS, RS)	Large, Small, None
Subwoofer (SW)	LFE, None

Speaker

- **Large** : Delivers full bandwidth sound with bass below 100 Hz.
- **Small** : If LFE is on, bass below 100 Hz will be outputted through a Subwoofer instead of the speakers. If LFE is off and the Front Speaker is set to Large, sound will be outputted through the Front Speaker.
- **None** : Select to disable the speakers.

Subwoofer Speaker

- **LFE** : Select to use the subwoofer speaker.
- **None** : Select to disable the subwoofer speaker.
(This option can only be selected when the Front (L+R) speakers are set to Large.)

Press the RED(A) button

- A test tone will be sent to **L → C → R → RS → LS → LFE** in order so you can make sure the speakers are set up correctly.
- To end the test tone, press the **RED (A)** button again.
- The test tone can only be activated when no discs are in the unit.

system setup

SETTING UP THE VIDEO DISPLAY/OUTPUT OPTIONS

This function allows you to setup the TV screen settings. This function depends on the disc or TV type. It may not work with some discs or TVs.

1. With the unit in Stop mode, press the **MENU** button.
2. Press the **▲▼** buttons to select **Setup**, then press the **ENTER** or **▶** button.
3. Press the **▲▼** buttons to select **Display Setup**, then press the **ENTER** or **▶** button.
Video setup menu will be displayed.
4. Press the **▲▼** buttons to select the desired display option from the options on the following pages.
5. Press the **▲▼** buttons to select the desired sub-menu item from a video display option, then press the **ENTER** button.

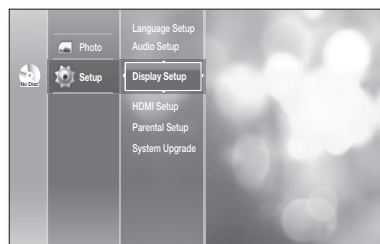

- Press the **RETURN** or **◀** button to return to the previous menu. Press the **MENU** button to exit the menu.

TV Aspect

Depending on the type of television you have, you may want to adjust the screen setting. (aspect ratio)



- **4:3 Letter Box :**
Select when you want to see the total 16:9 ratio screen BD/DVD supplies, even though you have a TV with a 4:3 ratio screen. Black bars will appear at the top and bottom of the screen.



- **4:3 Pan-Scan :**
Select this for conventional size TV when you want to see the central portion of the 16:9 screen. (Extreme left and right side of movie picture will be cut off.)



- **16:9 Wide :**
You can view the full 16:9 picture on your widescreen TV.



- Depending on the disc type, some aspect ratios may not be available.
- Certain movies will be displayed in 4:3 Pillarbox (black bars on sides of picture) even if 16:9 wide is selected.

Movie Frame (24 Fs)

Movies are usually filmed at 24 frames per second. Some Blu-ray Discs have the capability of playing back at this frame rate. Setting the Movie Frame (24Fs) feature to ON allows you to adjust the Blu-ray player's HDMI output to 24 frames per second for improved picture quality.

You can enjoy the Movie Fame (24Fs) feature solely on a TV supporting this frame rate.

This menu can only be selected in 1080i or 1080p HDMI output resolution modes.

Depending on the disc, two types of source may be included: Movie material (24 frame) and Video material (30 frame). When the source switches between Movie and Video, the screen may blink for a few seconds.

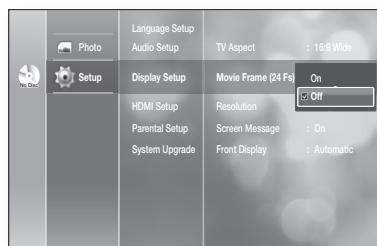

Resolution

Sets the output resolution of the Component and HDMI video signal.

- The number in 480i, 480p, 720p, 1080p and 1080i indicates the number of lines of video. The i and p indicate interlace and progressive scan, respectively.
 - 1080p : Outputs 1080 lines of progressive video.
 - 1080i : Outputs 1080 lines of interlaced video.
 - 720p : Outputs 720 lines of progressive video.
 - 480p : Outputs 480 lines progressive video.
 - 480i : Outputs 480 lines of interlaced video.



If the connected TV does not support the movie frame or the selected resolution, you will see the following message:

If you select Yes and the resolution is not supported, the TV's screen will be blank.

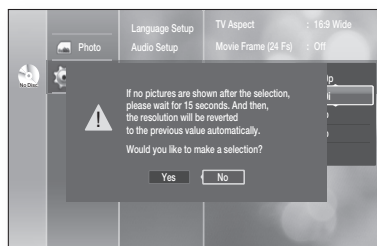

- If the screen is blank, press and hold the ►► button on the front of the player for more than 5 seconds (no disc inserted). All settings are restored to the factory default. Follow the steps on the previous page to access each mode and select the Display Setup that your TV will support.

system setup

❖ Resolution according to the output mode

• BD playback

Setup \ Output	HDMI	Component	VIDEO/S-Video
1080p, Movie Frame(24Fs) off	1080P@60F	1080i	480i
1080p/1080i, Movie Frame (24Fs) on	1080P@24F	1080i	480i
1080i, Movie Frame (24Fs) off	1080i	1080i	480i
720P	720P	720P	480i
480P	480P	480P	480i
480i	480P	480i	480i

• DVD playback

Setup \ Output	HDMI	Component	VIDEO/S-Video
1080p	1080P@60F	480P	480i
1080i	1080i	480P	480i
720P	720P	480P	480i
480P	480P	480P	480i
480i	480P	480i	480i



- This player has the HDMI Auto Detect Feature. When the player is first connected to a TV via HDMI, the player's output will be set automatically to HDMI.
- If the HDMI Auto Detection feature does not work, you can't select the 1080p resolution or Movie Frame (24Fs).
- The BD disc must have the 24 frame feature in order to use the Movie Frame (24Fs) mode.
- If you have both HDMI and Component cables connected to your TV, the Component resolution may differ from the chart above.

Screen Message

- **On** : Displays messages related to operation mode.
- **Off** : Does not display messages related to operation mode.

Front Display

- **Automatic** : Display is dark during playback and bright when the unit is in Stop mode.
- **Dim** : Select to dim the display window.
- **Bright** : Select to brighten the display window.

SETTING UP THE HDMI SETUP OPTIONS

1. With the unit in Stop mode, press the **MENU** button.
2. Press the **▲▼** buttons to select **Setup**, then press the **ENTER** or **▶** button.
3. Press the **▲▼** buttons to select **HDMI Setup**, then press the **ENTER** or **▶** button.
HDMI setup menu will be displayed.
4. Press the **▲▼** buttons to select the desired display option (Anynet or Format), then press the **ENTER** or **▶** button.



Anynet+ (HDMI-CEC)

When HDMI is set to on, you can operate Anynet+ function.

- **On** : Anynet+ functions will work.
- **Off** : Anynet+ function will not work.

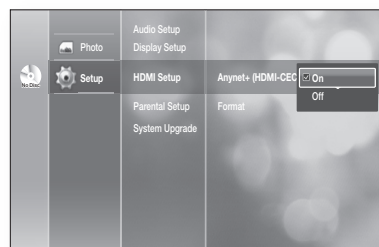

What is Anynet+?

Anynet+ is a convenient function that offers linked operations with other Samsung products with the Anynet+ feature.

You can operate this unit using a Samsung TV remote control or power on the Samsung TV and Home theater and start disc playback simply by pressing the **PLAY** button on the Blu-ray player's remote.



- This function is not available if the HDMI cable does not support CEC.

To use Anynet+

1. Connect the **BD Player** to a Samsung TV with an HDMI cable. (See pages 20~21)
2. Set the Anynet+ (HDMI CEC) to "On" on your **BD Player**.
3. Set the Anynet+ function on your TV. (See the TV instruction manual for more information.)

Anynet+ Functions

- One touch play
You can power on your Samsung TV and Home Theater, and play the disc in this unit simply by pressing the **PLAY** button on the Blu-ray player's remote.
- One touch watching
Select "Watching BD" or "Connected to BD player" (depending on your TV's menu) in the Anynet+ menu on the TV. The Blu-ray player will automatically turn on and the TV will be switched to HDMI mode.
- Remote control Link
You can operate this player with your Samsung TV remote control.

system setup

- Available buttons on the Samsung TV remote: These buttons work the same as this player's remote control.

- Playback control buttons : ⏪ ⏩ ⏸ ⏹
- Menu operation button : ⏏
- Numeric buttons : 0 ~ 9
- Color buttons : 🔴 🔵 🔴 🔵

TV Anynet+ Menu

When pressing the Anynet+ button on your Samsung TV's remote control, the following On-Screen Display (OSD) will be shown.

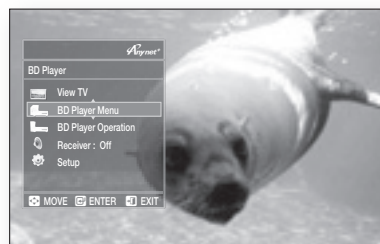

- BD Player Menu
 - When playing a movie : brings up the disc's menu (same as **DISC MENU** button on the Blu-ray player's remote control)
 - In Stop mode : brings up the SETUP menu (same as the **MENU** button on the Blu-ray player's remote control.)
- BD Player Operation Menu
 - When playing a DVD VIDEO, DVD-RW/-R, BD-ROM : shows INFO OSD (same as **INFO** button on the player's remote control)

 ■ These menus will vary from Samsung TV to TV.

Format

You can optimize the HDMI output for connection to a TV or Monitor.

- **TV** : Select if connected to a TV via HDMI.
- **Monitor** : Select if connected to a Monitor via HDMI.

If the player is connected to a TV, the Monitor option is unavailable.

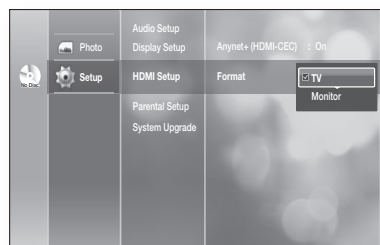

SETTING UP THE PARENTAL LOCK

The Parental Lock function works in conjunction with BD/DVDs that have been assigned a rating which helps you control the types of BD/DVDs that your family watches. There are up to 8 rating levels on a disc.



1. With the unit in Stop mode, press the **MENU** button.
2. Press the **▲▼** buttons to select **Setup**, then press the **ENTER** or **▶** button.
3. Press the **▲▼** buttons to select **Parental Setup**, then press the **ENTER** or **▶** button.
When you operate your Blu-ray Disc Player for the first time, the “Enter New password” message will be displayed.
4. Enter the 4-digit password using the number buttons on the remote control.
The “Confirm the password” message will be displayed.
Enter your password again.
5. Press the **ENTER** or **▶** button to select **Parental Lock**.
6. Press the **▲▼** buttons to select **On** or **Off**, then press the **ENTER** button.

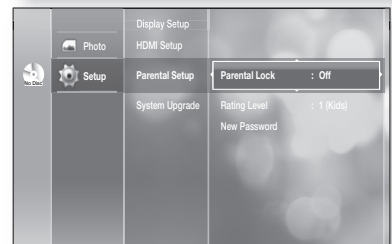
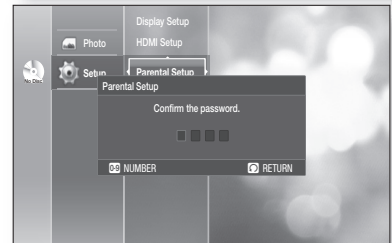
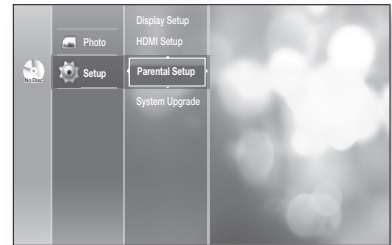

- Press the **RETURN** or **◀** button to return to the previous menu.
Press the **MENU** button to exit the menu.

If you forgot your password

1. Remove the disc.
2. Press and hold the **▶▶▶** button on the front panel for 5 seconds or more.
 - All settings will revert to the factory settings.

system setup

Setting the Rating Level

1. Press the ▲▼ buttons to select **Rating Level**, then press the **ENTER** or ► button.

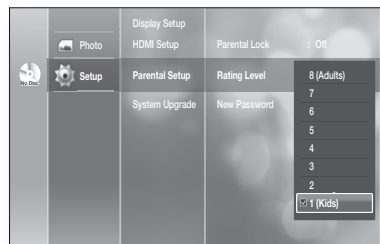

2. Press the ▲▼ buttons to select the rating level you want, then press the **ENTER** button. For example, if you select up to Level 6, discs that contain Level 7, 8 will not play. A larger number indicates that the program is intended for adult use only. Level 1 is the most restrictive and Level 8 is the least.

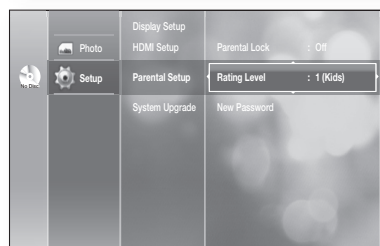

Changing the Password

1. Press the ▲▼ buttons to select **New Password**, then press the **ENTER** or ► button.

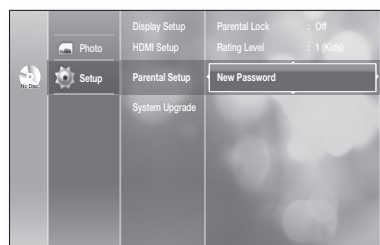

2. Enter the 4-digit password using the number buttons on the remote control. The “Enter New password.” message will be displayed.

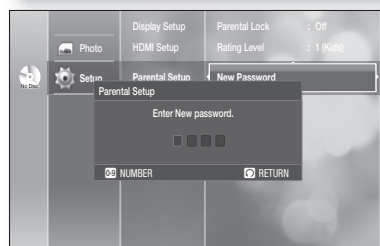

3. Enter your password again using the number buttons on the remote control.

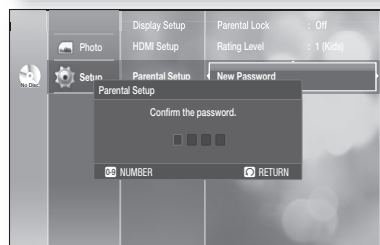

system upgrade

Samsung may offer upgrades to your Blu-ray player's firmware in the future. To upgrade this firmware you must :

1. Go to samsung.com and refer to 'SUPPORT' page to download the firmware and burn an update CD.
or
2. Connect this player's LAN terminal to the LAN terminal on your modem (see page 30) and follow the steps below.

FIRMWARE UPGRADE

1. With the unit in No Disc mode, press the **MENU** button.
2. Press the **▲▼** buttons to select **Setup**, then press the **ENTER** or **▶** button.
3. Press the **▲▼** buttons to select **System Upgrade**, then press the **ENTER** or **▶** button.
4. Press the **▲▼** buttons to select **Upgrade Start**, then press the **ENTER** or **▶** button.

5. You will see a window that allows you to check the cable or network connection status.

- If the upgrade is possible : You will see information on the current and new versions of firmware in a message box.

- If the upgrade is not possible : You will see the following description in the message box.

- If the cable is not connected :
"This system can not connect to internet for update.
Please, check the network setup."
- If the network connection has failed :
"This system can not connected to internet for update.
Please, check the network setup"
- If no later version is released (the latest version has been already installed) :
"The latest version of the firmware is already installed. There is no need to update."
- If there is a disc in the player :
"Please maintain "No Disc" state for network update."
This indicates that you must remove all discs from the unit to perform the update.

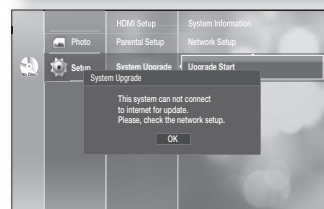
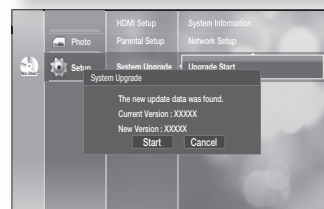
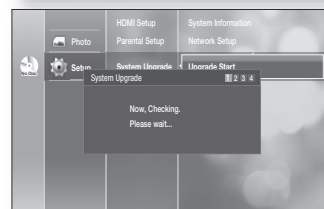
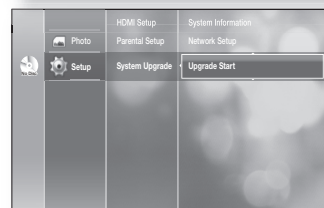
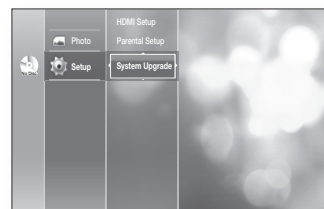

system upgrade

- To perform the system upgrade, press the ◀▶ buttons to select **Start** and then press the **ENTER** button.

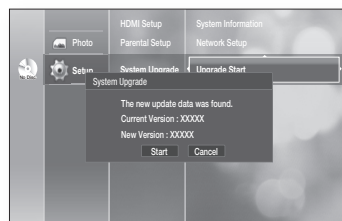

- The system update gets started.

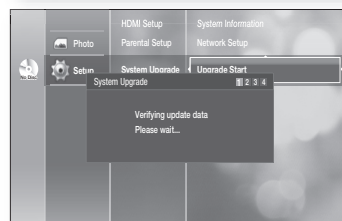
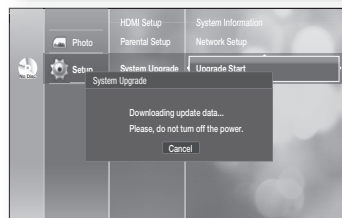

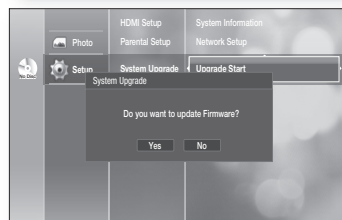

- When the verification is done, you will see a window that allows you to update firmware. To perform the firmware update, press the ◀▶ buttons to select **Yes** and then press the **ENTER** button.

- You will see a message about the upgrade process for 3seconds.
 - When update is finished, the power will turn off.
- If you do not want to update firmware, select **No** and then press the **ENTER** button.

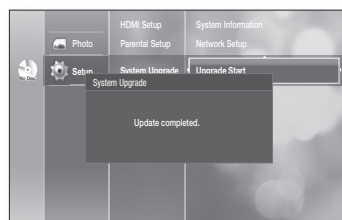

- When the installation is done, you will see a message of **“Update Completed”**. The player will automatically turn off in 3 seconds. All settings will revert to the factory settings. And the next time you start the system, you will see the menu language selection window.



-  If you want to cancel the upgrade in the process of downloading the upgrade data, press the **ENTER** button. You will see a confirmation message. Selecting **Yes** will end the upgrade process, and selecting **No** will proceed with the verification step.
- When the system upgrade is done, check the firmware details in the System Upgrade menu.
- Do not turn off the player during the System Upgrade. Otherwise, the player may not work properly.

SYSTEM INFORMATION

When the firmware upgrade is done, check the firmware details by following the steps below.

1. With the unit in Stop mode, press the **MENU** button.
2. Press the **▲▼** buttons to select **Setup**, then press the **ENTER** or **▶** button.
3. Press the **▲▼** buttons to select **System Upgrade**, then press the **ENTER** or **▶** button.
4. Press the **▲▼** buttons to select **System Information**, then press the **ENTER** or **▶** button.
You can see detailed information about the current firmware.
5. Press the **ENTER** button to select **OK**.
System Upgrade menu will be displayed.

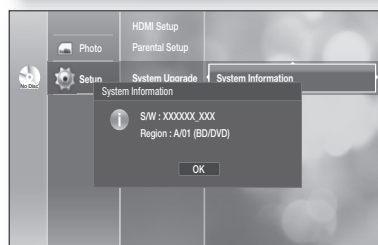
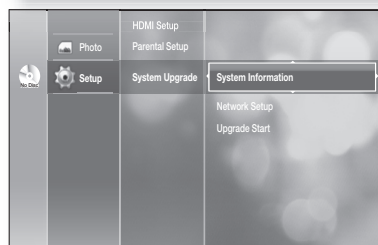
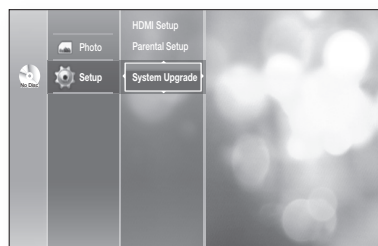

NETWORK SETUP

In some rare cases, the firmware upgrade may not succeed. If this occurs, you may need to set up your IP address, Subnet, Mask, Gateway and DNS by following the steps below.

- To setup, follow steps 1 and 3 above
4. Press the **▲▼** buttons to select **Network setup**, then press the **ENTER** or **▶** button.
You will see a menu that allows you to make network settings.
 5. Press the **▲▼** buttons to select **DHCP**, then press the **ENTER** button.

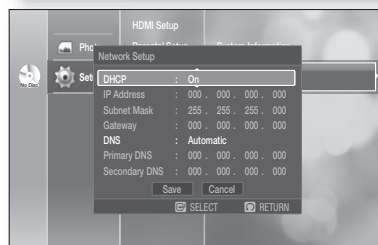
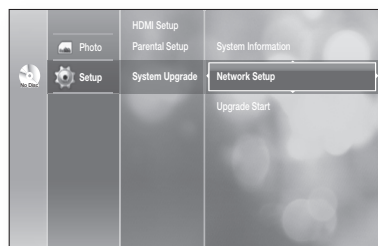

- If DHCP is set to On, you can't select IP Address, Subnet Mask or Gateway.
- If DNS is set to Automatic, you can't select Primary/ Secondary DNS.

system upgrade

6. Press the ▲▼ buttons to select a desired item, then press the **ENTER** button.

- If DHCP is set to Off and DNS is set to Manual

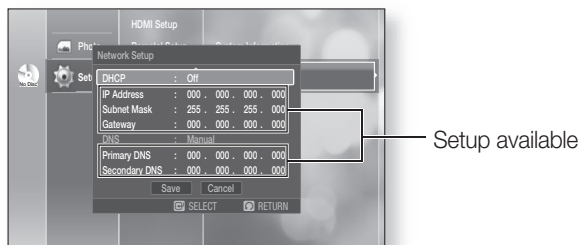

- If DHCP is set to On and DNS is set to Manual



- If DHCP is set to On and DNS is set to Automatic

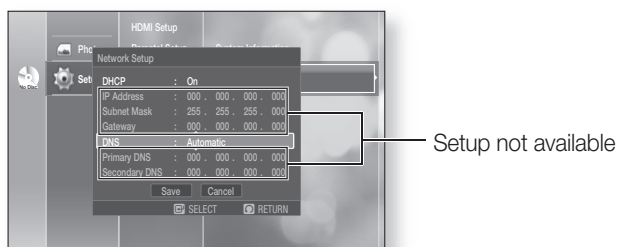

 ■ When you select an item, use the number and ▲▼◀▶ buttons.

7. When done, use the ▲▼ buttons to select **Save**, then press the **ENTER** button.

8. If you don't want to save your work, use the ▲▼◀▶ buttons to select **Cancel**, then press the **ENTER** button.

 ■ The IP address used in this manual is for illustrative purposes only. You must refer to your network settings for the actual IP address.

watching a movie

USING THE DISPLAY FUNCTION



1. During playback, press the **INFO** button on the remote control.
2. Press the **▲▼** buttons to select the desired item.
3. Press the **◀▶** buttons to make the desired setup and then press the **ENTER** button.
 - You may use the number buttons of the remote control to directly access a title, chapter or to start the playback from a desired time.
4. To make the screen disappear, press the **INFO** button again.



- If you are playing contents from the Info menu, in some cases, playback may malfunction depending on the title.
- Title : To access the desired title when there is more than one in the disc. For example, if there is more than one movie on a BD/DVD, each movie will be identified as a Title.
- Chapter: Most BD/DVD discs are recorded in chapters so that you can quickly find a specific passage.
- Audio : Refers to the film's soundtrack language. A BD disc can contain up to 32 audio languages and a DVD up to 8.
- Playing Time : Allows playback of the film from a desired time. You must enter the starting time as a reference. The time search function does not operate on some discs.
- Subtitle : Refers to the subtitle languages available in the disc. You will be able to choose the subtitle languages or, if you prefer, turn them off from the screen. A BD disc can contain up to 255 subtitle languages, and a DVD up to 32.
- Angle : When a BD/DVD contains multiple angles of a particular scene, you can use the ANGLE function.

watching a movie

USING THE DISC MENU & POPUP/TITLE MENU

Using the Disc Menu



1. During playback, press the **DISC MENU** button on the remote control.
2. Press the **▲▼◀▶** buttons to make the desired setup, then press the **▶** or **ENTER** button.
 - The Disc menu setup items may vary from disc to disc.



-
-  ■ Depending on the disc, the Disc Menu may not be available.

Using the Title Menu



1. During playback, press the **TITLE MENU** button on the remote control.
2. Press the **▲▼◀▶** buttons to make the desired setup, then press the **ENTER** button.
 - The Title menu setup options may vary from disc to disc.

-
-  ■ Depending on the disc, the Title Menu may not be available.
- Title Menu will only be displayed if there are at least two titles in the disc.

Using the Popup Menu



1. During playback, press the **POPUP MENU** button on the remote control.
2. Press the **▲▼◀▶** buttons or **ENTER** button to select the desired menu.
 - The Popup menu setup options may vary from disc to disc.

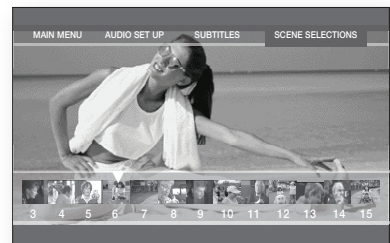

-
-  ■ Depending on the disc, the Popup Menu may not be available.

REPEAT PLAY

Repeat the current chapter or title.

Repeat playback



1. During playback, press the **REPEAT** button on the remote control. Repeat screen appears.
2. Press the **▲▼** buttons to select **Chapter** or **Title**.
 - BD/DVD repeats play by chapter or title.
3. To return to normal play, press the **REPEAT** button again, then press the **▲▼** buttons to select **Off**.

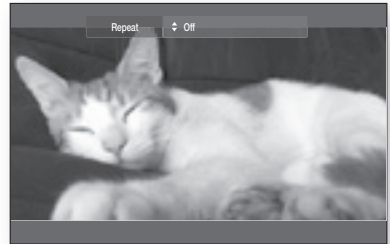

- Depending on the disc, the Repeat function may not be available.

Using the A-B Repeat function



1. Press the **Repeat A-B** button on the remote control.
2. Press the **Repeat A-B** button at the point where you want repeat play to start (A).
3. Press the **Repeat A-B** button at the point where you want repeat play to stop (B).
4. To return to normal play, press the **CANCEL** button.



- Point B cannot be set until 5 seconds of playback has elapsed from point A.

SELECTING THE AUDIO LANGUAGE



You can select a desired audio language quickly and easily with the **AUDIO** button.

Using the AUDIO button

1. Press the **AUDIO** button during playback. The Audio changes when the button is pressed repeatedly.
 - The audio languages are represented by abbreviations.
2. To remove the **AUDIO** icon, press the **CANCEL** or **RETURN** button.

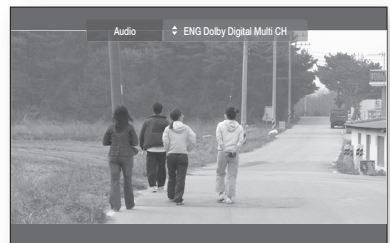

watching a movie

Using the INFO button

1. During playback, press the **INFO** button on the remote control.
2. Press the ▲▼ buttons to select Audio language.
3. Press the ◀▶ buttons on the remote control to select the desired audio.



- This function depends on what audio languages are encoded on the disc and may not be available.
- A BD disc can contain up to 32 audio languages and a DVD up to 8.
- Depending on the disc type, you can use the Audio button to change the audio sound track as well as the audio language.
Some Blu-ray Discs may allow you to select either multi-channel LPCM or Dolby digital audio sound track in English sound tracks.

SELECTING THE SUBTITLE LANGUAGE

You can select a desired subtitle quickly and easily with the **SUBTITLE** button.

Using the SUBTITLE button



1. Press the **SUBTITLE** button. The subtitle changes when the button is pressed repeatedly. The subtitle languages are represented by abbreviations.
2. To remove the **SUBTITLE** icon, press the **CANCEL** or **RETURN** button.

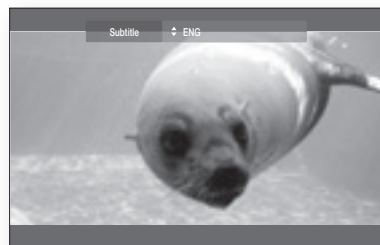

Using the INFO button

1. During playback, press the **INFO** button on the remote control.
2. Press the ▲▼ buttons to select **Subtitle**.
3. Press the ◀▶ buttons on the remote control to select the desired subtitle language.



- Depending on BD/DVDs, you may have to change the desired subtitle in the Disc Menu. Press the **DISC MENU** button.
- This function depends on what subtitles are encoded on the disc and may not be available on all BD/DVDs.
- A BD disc can contain up to 255 subtitle languages and a DVD up to 32.

CHANGING THE CAMERA ANGLE

When a BD/DVD contains multiple angles of a particular scene, you can use the ANGLE function.

Using the ANGLE function



1. During playback, press the **INFO** button on the remote control.
2. Press the **▲▼** buttons to select **Angle**.
3. Press the **◀▶** buttons or you can use the number buttons on the remote control to select the desired angle.

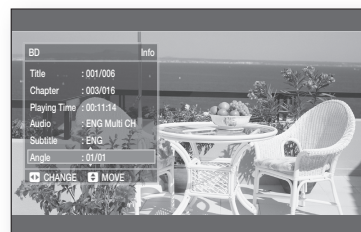

- If the disc has only one angle, this feature won't work. Currently, very few discs have this feature.
- Depending on the disc, these functions may not work.

USING THE BOOKMARK FUNCTION

The features lets you bookmarks sections of a DVD so you can quickly find them at a later time.

Using the MARKER button



1. During playback, press the **MARKER** button on the remote control.
The Bookmark screen appears.
2. Press the **ENTER** button when the desired scene appears.
The selected scene will be stored.
3. Press the **◀▶** buttons to move to the next position.
4. Press the **ENTER** button again when the desired scene appears.
The scene will be stored at the selected position and the bookmark time information will be shown.
 - Repeat above to bookmark other positions.
 - You can bookmark up to 8 scenes.



- When the disc tray is opened and then closed, bookmarks will disappear.

watching a movie

Playing back a bookmark

1. During playback, press the **MARKER** button on the remote control.



2. Press the ◀▶ buttons to select a bookmarked scene.
3. Press the **ENTER** or **PLAY/PAUSE**(▶) button to start playing from the selected scene.

Clearing a bookmark

1. During playback, press the **MARKER** button on the remote control.



2. Press the ◀▶ buttons to select a bookmarked scene.



3. Press the **RED(A)** or **CANCEL** button to delete the selected bookmark.



listening to music

PLAYING AN AUDIO CD(CD-DA)



1. Insert an Audio CD(CD-DA) into the disc tray.
For an audio CD, the first track will be played automatically.
2. To move to the Music List, press the **STOP** or **RETURN** button.
The Music List screen is displayed
3. Press the **▲▼** buttons to select the track you want to play, and then press the **ENTER** button.

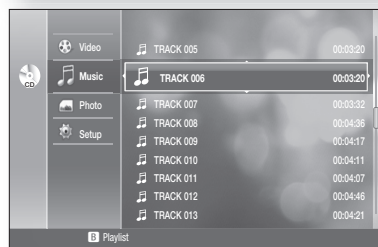
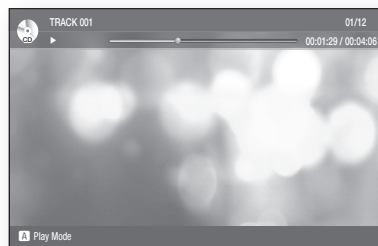

PLAYING AN MP3



1. Insert an MP3 disc into the disc tray.
 - The Menu screen is displayed.
2. Press the **▲▼** buttons to select **Music**, then press the **ENTER** button.
 - The Music List is displayed.
3. Press the **▲▼** buttons to select the MP3 file you want to play, and then press the **ENTER** button.

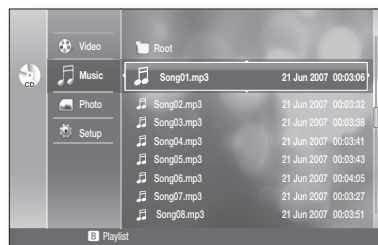

AUDIO CD(CD-DA)/MP3 SCREEN ELEMENTS

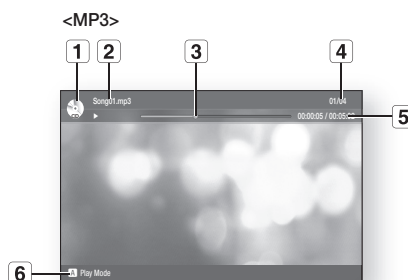
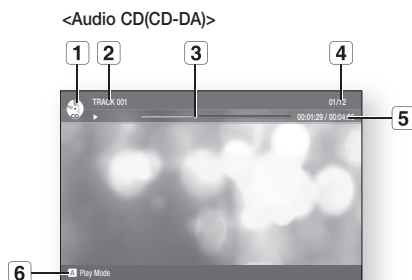

1	Displays the media type.	3	Play Status Bar.
2	Current track (song) Audio CD(CD-DA) : Displays the number of the track currently being played. MP3 : Displays the name of the track currently being played.	4	Displays the current play index, total track number.
		5	Current /Total Play Time.
		6	Displays available COLOR buttons. (see next page for Color button usage).

listening to music

BUTTONS ON THE REMOTE CONTROL USED FOR AUDIO CD (CD-DA)/ MP3 DISC PLAYBACK

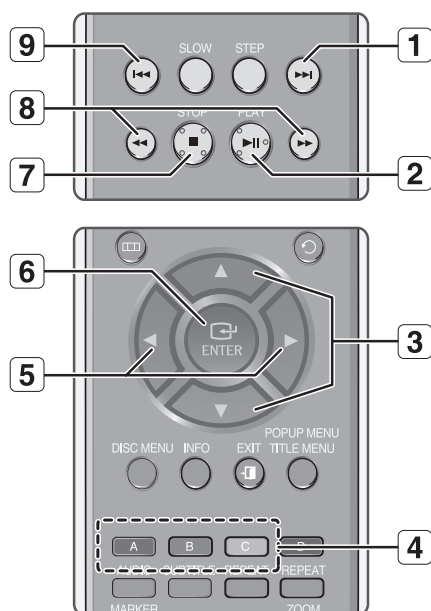

1. **SKIP** (⏭) button: During playback, plays the next track. Moves to the next page in the Music List or the Playlist.
2. **PLAY/PAUSE** (⏮) button: Plays the currently selected track. If pressed during playback, the current track is paused.
3. **▲▼** buttons : Selects a track(song) or a folder in Music List or Playlist.
4. **COLOR** buttons: RED(A), GREEN(B), YELLOW(C)
 - RED(A) button : Selects the Play Mode(Repeat) during playback.
 - GREEN(B) button : Go to Playlist from Music List/Go to Music list from Playlist.
 - YELLOW(C) button : Playlist play.
5. **◀▶** buttons
 - ▶ : Moves to the applicable folder or plays the applicable track, according to the current position.
 - ◀ : Moves to the parent folder.
6. **ENTER** button : Plays the selected track (song).
7. **STOP** (⏹) button: Stops a track(song).
8. Press the **SEARCH** (⏮) buttons : Fast Play (only Audio CD(CD-DA)).
9. **SKIP** (⏮) button: Returns to the beginning of the current track when pressed during playback. If pressed again, your Blu-ray Disc Player moves to and plays the previous track. If you press this button within three seconds after playback starts, the previous track will be played. If you press this button after three seconds, the current track will be replayed from the beginning. Moves by the page in the Music List or the Playlist.

REPEAT AUDIO CD(CD-DA) & MP3

During playback, press the **REPEAT** or **RED(A)** button repeatedly to select the repeat mode you want.

When playing an Audio CD(CD-DA) :

Normal → → → →

When playing an MP3 disc :

Normal → → →

- **Normal (Audio CD(CD-DA)/MP3):** Tracks on a disc are played in the order in which they were recorded on the disc.
- **Repeat Track (Audio CD(CD-DA)/MP3)**
- **Repeat Folder (MP3)**
- **Random (Audio CD(CD-DA)/MP3)**
 - **When playing an Audio CD(CD-DA):** The random option plays a disc's track in random order.
 - **When playing an MP3 disc :** The random option plays a folder's file in random order.
- **Repeat All (Audio CD(CD-DA)):** All tracks are repeated.

- **To return to normal playback -**

Press the **REPEAT** or **RED(A)** button repeatedly to return to normal playback.

Playlist

You can create a playlist with up to 99 tracks.

To setup, follow steps 1 to 2 in page 55.

1. Press the **GREEN(B)** button.

2. Press the **▲▼** buttons to select a track, then press the **ENTER** button to add it to the Playlist. Repeat this procedure to add additional tracks.

3. If there is an undesired track in the playlist, press the **▶▲▼** button to select that track, and then press the **ENTER** button.

- The selected track will be deleted.

4. Press the **YELLOW(C)** button to play the selected tracks. When the track is finished, the next track will automatically play.

5. To go back to the Music List, press the **STOP** or **RETURN** button.

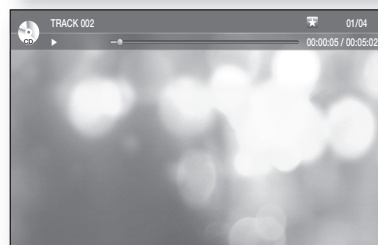
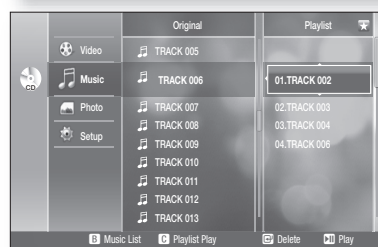
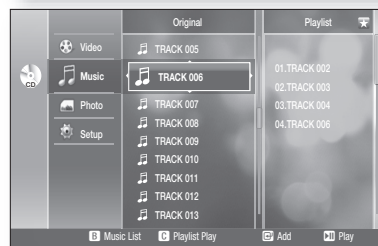
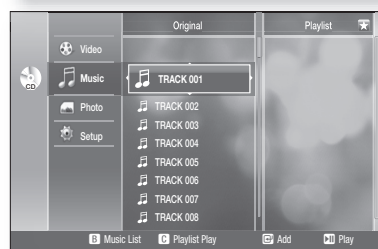
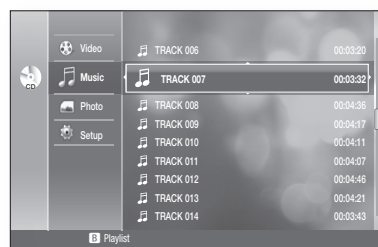

Viewing a Picture

VIEWING A PICTURE

1. Insert a JPEG disc into the disc tray.
 - The Menu screen is displayed.
2. Press the ▲▼ buttons to select **Photo**, then press the **ENTER** button.
 - The Photo List is displayed.
3. Press the ▲▼ buttons to select a picture.
 - To see the next page, press the **SKIP** (⏩) button.
 - To see the previous page, press the **SKIP** (⏪) button.



 ■ Photo files larger than 6Mb or with more than 7 million pixels may not be played.

SLIDE SHOW

To setup, follow steps 1 and 2 above.

3. Press the **BLUE(D)** button.
The slide show starts.
4. When the SlideShow starts, press the **BLUE(D)** button to adjust the play speed.
Each time you press the button, the play speed will increase accordingly.

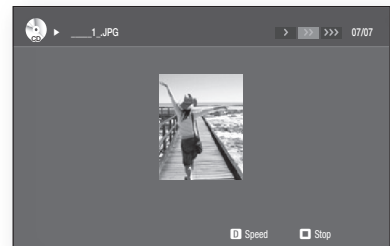

- To stop the Slide Show -
Press the **STOP** or **RETURN** button.

 ■ JPEG's smaller than 1920 x 1080 will be displayed at normal resolution. They will not fully fill the screen.

ROTATE

To setup, follow steps 1 and 3 above.

4. Press the **ENTER** button.
5. Use the **RED(A)** and **GREEN(B)** buttons to rotate the image in a desired direction.

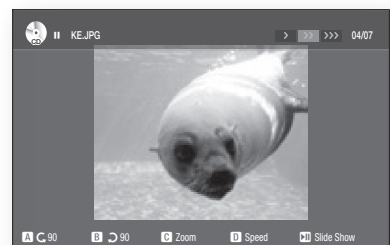

 ■ Photo files larger than 6Mb or with more than 7 million pixels cannot be rotated.

ZOOM

To setup, follow steps 1 to 3 in "Viewing a Picture" on page 58.

4. Press the **ENTER** button.
5. Press the **YELLOW(C)** button.

6. Use the **RED(A)** and **GREEN(B)** buttons to zoom in/out the image.

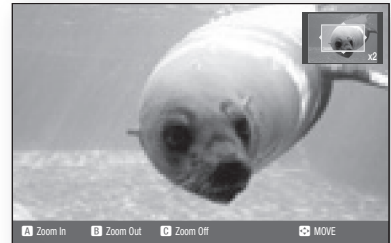
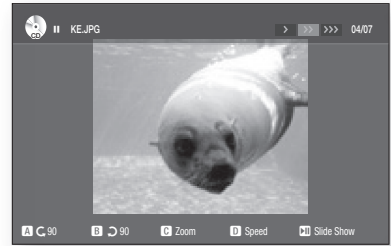

- To stop the Zoom -
Press the **YELLOW(C)** button.

GO TO PHOTO LIST

To setup, follow steps 1 to 3 in "Viewing a Picture" on page 58.

4. Press the **ENTER** button.
5. To go Photo List, press the **RETURN** or **STOP** button.

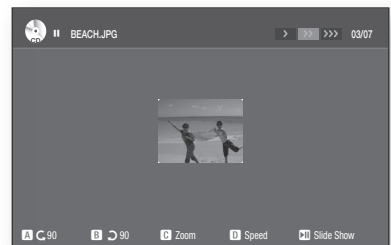

troubleshooting

Before requesting service, please check the following.

PROBLEM	SOLUTION
No operations can be performed with the remote control.	<ul style="list-style-type: none">• Check the batteries in the remote control. They may need replacing.• Operate the remote control at a distance of no more than 20 feet.• Remove batteries and hold down one or more buttons for several minutes to drain the microprocessor inside the remote control to reset it. Reinstall batteries and try to operate the remote control again.
Disc does not play.	<ul style="list-style-type: none">• Ensure that the disc is installed with the label side facing up.• Check the region number of the BD/DVD.
5.1 channel sound is not being reproduced.	<ul style="list-style-type: none">• 5.1 channel sound is reproduced only when the following conditions are met. :<ol style="list-style-type: none">1. The Blu-ray Disc Player is connected with the proper Amplifier2. The disc is recorded with 5.1 channel sound.• Check whether the disc being played has the “5.1 ch” mark on the outside.• Check if your audio system is connected and working properly.• In a SETUP Menu, is the Audio Output set to Bitstream?
Disc Menu doesn't appear.	<ul style="list-style-type: none">• Check if the disc has a Menu.
The  icon appears on screen.	<ul style="list-style-type: none">• The features or action cannot be completed at this time because:<ol style="list-style-type: none">1. The BD/DVD's software restricts it.2. The BD/DVD's software doesn't support the feature (e.g., angles)3. The feature is not available at the moment.4. You've requested a title or chapter number or search time that is out of range.
Play mode differs from the Setup Menu selection.	<ul style="list-style-type: none">• Some of the functions selected in the Setup Menu may not work properly if the disc is not encoded with the corresponding function.
The screen ratio cannot be changed.	<ul style="list-style-type: none">• The Screen Ratio is fixed on your BD/DVDs.
No audio.	<ul style="list-style-type: none">• Make sure you have selected the correct Digital Output in the Audio Options Menu.
The screen is blocked	<ul style="list-style-type: none">• Press the ▶▶ button (in front panel) for more than 5 seconds with no disc inside. All settings will revert to the factory settings.

PROBLEM	SOLUTION
If the HDMI output is set to a resolution your TV cannot support (for example, 1080p), you may not see a picture on your TV.	<ul style="list-style-type: none"> • Press the ►►I button (in front panel) for more than 5 seconds with no disc inside. All settings will revert to the factory settings.
Forgot password	<ul style="list-style-type: none"> • Press the ►►I button (in front panel) for more than 5 seconds with no disc inside. All settings including the password will revert to the factory settings. Don't use this unless absolutely necessary.
If you experience other problems.	<ul style="list-style-type: none"> • Go to the contents and find the section of the instruction book that contains the explanations regarding the current problem, and follow the procedure once again. • If the problem still cannot be solved, please contact your nearest Samsung authorized service center.
The picture is noisy or distorted	<ul style="list-style-type: none"> • Make sure that the disc is not dirty or scratched. • Clean the disc.
No HDMI output.	<ul style="list-style-type: none"> • Check the connection between the TV and the HDMI jack of the Blu-ray Disc Player. • Check if your TV supports 480p/720p/1080i/1080p HDMI input resolution.
Abnormal HDMI output screen.	<ul style="list-style-type: none"> • If random noise appears on the screen, it means that TV does not support HDCP (High-bandwidth Digital Content Protection).

appendix

SPECIFICATIONS

General	Power Requirements	AC 120V, 60Hz
	Power Consumption	29 W
	Weight	9.3 lbs
	Dimensions	16.9 (W) x 12.8 (D) x 3.1 (H) inches
	Operating Temperature Range	+41°F to +95°F
	Operating Humidity Range	10 % to 75 %
Disc	BD (Blu-ray Disc)	Reading Speed : 4.917m/sec
	DVD (Digital Versatile Disc)	Reading Speed : 3.49 ~ 4.06 m/sec. Approx. Play Time (Single Sided, Single Layer Disc) : 135 min.
	CD : 5 inches (COMPACT DISC)	Reading Speed : 4.8 ~ 5.6 m/sec. Maximum Play Time : 74 min.
	CD : 3 1/2 inches (COMPACT DISC)	Reading Speed : 4.8 ~ 5.6 m/sec. Maximum Play Time : 20 min.
Video Output	Composite Video	1 channel : 1.0 Vp-p (75 Ω load)
		Blu-ray Disc : 480i DVD : 480i
	Component Video	Y : 1.0 Vp-p (75 Ω load)
		Pr : 0.70 Vp-p (75 Ω load)
		Pb : 0.70 Vp-p (75 Ω load)
		Blu-ray Disc : 1080i, 720p, 480p, 480i DVD : 480p, 480i
S-Video	Luminance Signal : 1.0 Vp-p (75 Ω load)	
	Chrominance Signal : 0.3 Vp-p (75 Ω load)	
	Blu-ray Disc : 480i DVD : 480i	
Video/Audio	HDMI	1080p, 1080i, 720p, 480p
		PCM multichannel audio, Bitstream audio, PCM audio
Audio Output	2 Channel	L(1/L), R(2/R)
	5.1 Channel	F/L, F/R, R/L, R/R, C/T, S/W
	Digital Audio Output	Optical/Coaxial
	*Frequency Response	48 kHz Sampling : 4 Hz to 22 kHz
		96 kHz Sampling : 4 Hz to 44 kHz
	*S/N Ratio	110 dB
	*Dynamic Range	100 dB
*Total Harmonic Distortion	0.003%	

*: Nominal specification

- Samsung Electronics Co., Ltd reserves the right to change the specifications without notice.
- Weight and dimensions are approximate.

COPY PROTECTION

- Because AACS (Advanced Access Content System) is approved as content protection system for BD format, similar to use of CSS (Content Scramble System) for DVD format, certain restrictions are imposed on playback, analog signal output, etc., of AACS protected contents. The operation of this product and restrictions on this product may vary depending on your time of purchase as those restrictions may be adopted and/or changed by AACS after the production of this product. Furthermore, BD-ROM Mark and BD+ are additionally used as content protection system for BD format, which imposes certain restrictions including playback restrictions for BD-ROM Mark and/or BD+ protected contents. To obtain additional information on AACS, BD-ROM Mark, BD+, or this product, please contact SAMSUNG customer care center.
- Many BD/DVD discs are encoded with copy protection. Because of this, you should only connect your Blu-ray Disc Player directly to your TV, not to a VCR. Connecting to a VCR results in a distorted picture from copy-protected BD/DVD discs.
- This product incorporates copyright protection technology that is protected by methods claims of certain U.S. patents and other intellectual property rights owned by Macrovision Corporation and other rights owners. Use of this copyright protection technology must be authorized by Macrovision Corporation and is intended for home and other limited viewing uses only, unless otherwise authorized by Macrovision Corporation. Reverse engineering or disassembly is prohibited.
- Under the U.S. Copyright laws and Copyright laws of other countries, unauthorized recording, use, display, distribution, or revision of television programs, videotapes, BDs, DVDs, CDs and other materials may subject you to civil and/or criminal liability.
- **For DVD Players with 525p, but not 625p, progressive scan output :**
 CONSUMERS SHOULD NOTE THAT NOT ALL HIGH DEFINITION TELEVISION SETS ARE FULLY COMPATIBLE WITH THIS PRODUCT AND MAY CAUSE ARTIFACTS TO BE DISPLAYED IN THE PICTURE. IN CASE OF 525 PROGRESSIVE SCAN PICTURE PROBLEMS, IT IS RECOMMENDED THAT THE USER SWITCH THE CONNECTION TO THE 'STANDARD DEFINITION' OUTPUT. IF THERE ARE QUESTIONS REGARDING OUR TV SET COMPATIBILITY WITH THIS MODEL 525p DVD PLAYER, PLEASE CONTACT OUR CUSTOMER SERVICE CENTER.

Compliance and Compatibility Notice

NOT ALL discs are compatible

- Subject to the restrictions described below and those noted throughout this Manual, including the Disc Type and Characteristics section of this Manual, disc types that can be played are: pre-recorded commercial BD-ROM, DVD-Video, and Audio CD discs; DVD-RW / DVD-R discs; and CD-RW/CD-R discs.
- Discs other than the above cannot and/or is not intended to be played by this player. And some of the above discs may not play due to one or more reasons provided below.
- HD DVD discs cannot be played in this player.
- Samsung cannot assure that this player will play every disc bearing the BD-ROM, DVD-Video, DVD-RW / DVD-R and CD-RW / CD-R logos, and this player may not respond to all operating commands or operate all features of every disc. These and other disc compatibility and player operation issues with new and existing format discs are possible because:
 - BD format is a new and evolving format and this player may not operate all features of BD discs because some features may be optional, additional features may have been added to the BD format after the production of this player, and certain available features may be subject to delayed availability;
 - not all new and existing disc format versions are supported by this player;
 - new and existing disc formats may be revised, changed, updated, improved and/or supplemented;
 - some discs are produced in a manner that allows specific or limited operation and feature during playback;
 - some features may be optional, additional features may have been added after the production of this player or certain available features may be subject to delayed availability;
 - some discs bearing the BD-ROM, DVD-Video, DVD-RW/ DVD-R and CD-RW/ CD-R logos may still be non-standardized discs;
 - some discs may not be played depending on their physical state or recording conditions;
 - problems and error can occur during the creation of BD, DVD and CD software and/or the manufacture of discs;
 - this player operates differently than a standard DVD player or other AV equipment; and/or
 - for reasons noted throughout this Manual and for other reason(s) discovered and posted by SAMSUNG customer care center.
- If you encounter disc compatibility or player operation problems, please contact SAMSUNG customer care center. You may also contact SAMSUNG customer care center for possible updates on this player.
- For additional information on playback restrictions and disc compatibility, refer to the Precautions, Before Reading the User's Manual, Disc Types and Characteristics, and Before Playing sections of this Manual.

appendix

WARRANTY (FOR USA USERS ONLY)

LIMITED WARRANTY TO ORIGINAL PURCHASER

This SAMSUNG brand product, as supplied and distributed by SAMSUNG ELECTRONICS AMERICA, INC. (SAMSUNG) and delivered new, in the original carton to the original consumer purchaser, is warranted by SAMSUNG against manufacturing defects in materials and workmanship for the following limited warranty period:

One (1) Year Parts / Ninety Days (90) Labor

This limited warranty begins on the original date of purchase, and is valid only on products purchased and used in the United States, and does not include transportation, installation, removal or reinstallation. Warranty repairs must be performed by SAMSUNG's authorized service center. To receive warranty service, the original dated bill of sale must be presented upon request as proof of purchase to SAMSUNG or SAMSUNG's authorized service center. Transportation to and from the service center is the responsibility of the purchaser.

SAMSUNG will repair or replace this product, at our option and at no charge with new or reconditioned parts, if found to be defective during the limited warranty period specified above. The product must be returned during the warranty period with transportation charges prepaid to SAMSUNG's designated service center. Prior to returning any product for warranty service, the purchaser must contact SAMSUNG for problem determination and service procedures. SAMSUNG does not warrant uninterrupted or error-free operation of the product.

All replaced parts and products become the property of SAMSUNG and must be returned to SAMSUNG. Replacement parts and products assume the remaining original warranty, or ninety (90) days, whichever is longer.

This limited warranty covers manufacturing defects in materials and workmanship encountered in normal, noncommercial use of this product and shall not apply to the following, including, but not limited to: damage which occurs in shipment; applications and uses for which this product was not intended; failures or problems which are caused by products or equipment not supplied by SAMSUNG; accidents, misuse, abuse, neglect, misapplication, fire, water, lightning or other acts of nature; incorrect electrical line voltage, fluctuations or surges; damage caused by improper or faulty installation; improper connection with any peripheral; product alteration or modification; improper or unauthorized repair; cosmetic damage or exterior finish; product with altered serial numbers; failure to follow operating instructions, customer adjustments, maintenance and environmental instructions that are covered and prescribed in the instruction book; use of non-SAMSUNG or unauthorized parts, supplies, accessories or equipment which damage this product or result in service problems; failures or problems due to incompatibility with other equipment.

No person, agent, distributor, dealer or company is authorized to change, modify or extend the terms of these warranties in any manner whatsoever. The time within which an action must be commenced to enforce any obligations of SAMSUNG arising under the warranty or under any statute, or law of the United States or of any state thereof, is hereby limited to ninety (90) days from the date you discovered or should have discovered the defect. This limitation does not apply to implied warranties arising under state law, if any.

SAMSUNG does not warrant (i) disc compatibility with new and existing format discs or (ii) error free playback in full compliance with specifications of the compatible disc formats, and SAMSUNG shall not be liable for any data loss recorded in your discs. SAMSUNG's responsibility shall be limited to appropriate warranty services during the warranty period through SAMSUNG customer care center. If you encounter compatibility or data loss problems, please contact SAMSUNG customer care center.

THERE ARE NO EXPRESS WARRANTIES OTHER THAN THOSE LISTED AND DESCRIBED ABOVE, AND NO WARRANTIES WHETHER EXPRESS OR IMPLIED, INCLUDING, BUT NOT LIMITED TO, ANY IMPLIED WARRANTIES OF MERCHANTABILITY OR FITNESS FOR A PARTICULAR PURPOSE, SHALL APPLY AFTER THE EXPRESS WARRANTY PERIODS STATED ABOVE, AND NO OTHER EXPRESS WARRANTY OR GUARANTY GIVEN BY ANY PERSON, FIRM OR CORPORATION WITH RESPECT TO THIS PRODUCT SHALL BE BINDING ON SAMSUNG. SAMSUNG SHALL NOT BE LIABLE FOR LOSS OF REVENUE OR PROFITS, FAILURE TO REALIZE SAVINGS OR OTHER BENEFITS, OR ANY OTHER SPECIAL, INCIDENTAL OR CONSEQUENTIAL DAMAGES CAUSED BY THE USE, MISUSE OR INABILITY TO USE THIS PRODUCT, REGARDLESS OF THE LEGAL THEORY ON WHICH THE CLAIM IS BASED, AND EVEN IF SAMSUNG HAS BEEN ADVISED OF THE POSSIBILITY OF SUCH DAMAGES. NOR SHALL RECOVERY OF ANY KIND AGAINST SAMSUNG BE GREATER IN AMOUNT THAN THE PURCHASE PRICE OF THE PRODUCT SOLD BY SAMSUNG AND CAUSING THE ALLEGED DAMAGE. WITHOUT LIMITING THE FOREGOING, PURCHASER ASSUMES ALL RISK AND LIABILITY FOR LOSS, DAMAGE OR INJURY TO PURCHASER AND PURCHASER'S PROPERTY AND TO OTHERS AND THEIR PROPERTY ARISING OUT OF THE USE, MISUSE OR INABILITY TO USE THIS PRODUCT SOLD BY SAMSUNG NOT CAUSED DIRECTLY BY THE NEGLIGENCE OF SAMSUNG. THIS LIMITED WARRANTY SHALL NOT EXTEND TO ANYONE OTHER THAN THE ORIGINAL PURCHASER OF THIS PRODUCT, IS NONTRANSFERABLE AND STATES YOUR EXCLUSIVE REMEDY.

Some states do not allow limitations on how long an implied warranty lasts, or the exclusion or limitation of incidental or consequential damages, so the above limitations or exclusions may not apply to you. This warranty gives you specific legal rights, and you may also have other rights which vary from state to state.

To obtain warranty service, please contact SAMSUNG customer care center.

Contact SAMSUNG WORLD WIDE

If you have any questions or comments relating to Samsung products, please contact the SAMSUNG customer care center.

Region	Country	Customer Care Center ☎	Web Site
North America	CANADA	1-800-SAMSUNG(726-7864)	www.samsung.com/ca
	MEXICO	01-800-SAMSUNG(726-7864)	www.samsung.com/mx
	U.S.A	1-800-SAMSUNG(726-7864)	www.samsung.com/us
Latin America	ARGENTINE	0800-333-3733	www.samsung.com/ar
	BRAZIL	0800-124-421 , 4004-0000	www.samsung.com/br
	CHILE	800-SAMSUNG(726-7864)	www.samsung.com/cl
	COSTA RICA	0-800-507-7267	www.samsung.com/latin
	ECUADOR	1-800-10-7267	www.samsung.com/latin
	EL SALVADOR	800-6225	www.samsung.com/latin
	GUATEMALA	1-800-299-0013	www.samsung.com/latin
	JAMAICA	1-800-234-7267	www.samsung.com/latin
	PANAMA	800-7267	www.samsung.com/latin
	PUERTO RICO	1-800-682-3180	www.samsung.com/latin
	REP. DOMINICA	1-800-751-2676	www.samsung.com/latin
	TRINIDAD & TOBAGO	1-800-SAMSUNG(726-7864)	www.samsung.com/latin
	VENEZUELA	0-800-100-5303	www.samsung.com/latin
	COLOMBIA	01-8000112112	www.samsung.com.co
Europe	BELGIUM	0032 (0)2 201 24 18	www.samsung.com/be
	CZECH REPUBLIC	844 000 844 Distributor pro Českou republiku : Samsung Zrt., česká organizační složka Vyskočilova 4, 14000 Praha 4	www.samsung.com/cz
	DENMARK	70 70 19 70	www.samsung.com/dk
	FINLAND	030-6227 515	www.samsung.com/fi
	FRANCE	3260 SAMSUNG(726-7864) or 08 25 08 65 65 (€ 0,15/Min)	www.samsung.com/fr
	GERMANY	01805 - 121213 (€ 0,14/Min)	www.samsung.de
	HUNGARY	06-80-SAMSUNG(726-7864)	www.samsung.com/hu
	ITALIA	800-SAMSUNG(726-7864)	www.samsung.com/it
	LUXEMBURG	0035 (0)2 261 03 710	www.samsung.com/be
	NETHERLANDS	0900 20 200 88 (€ 0,10/Min)	www.samsung.com/nl
	NORWAY	815-56 480	www.samsung.com/no
	POLAND	0 801 801 881 , 022-607-93-33	www.samsung.com/pl
	PORTUGAL	80 8 200 128	www.samsung.com/pt
	SLOVAKIA	0800-SAMSUNG(726-7864)	www.samsung.com/sk
	SPAIN	902 10 11 30	www.samsung.com/es
	SWEDEN	0771-400 200	www.samsung.com/se
	U.K	0870-SAMSUNG(726-7864)	www.samsung.com/uk
	Republic of Ireland	0818 717 100	www.samsung.com/ie
	AUSTRIA	0800-SAMSUNG(726-7864)	www.samsung.com/at
	Switzerland	0800-SAMSUNG(726-7864)	www.samsung.com/ch
CIS	RUSSIA	8-800-555-55-55	www.samsung.ru
	KAZAHSTAN	8-10-800-500-55-500	www.samsung.kz
	UZBEKISTAN	8-800-120-0-400	www.samsung.uz
	KYRGYZSTAN	00-800-500-55-500	
	UKRAINE	8-800-502-0000	www.samsung.ua
	LITHUANIA	8-800-77777	www.samsung.lt
	LATVIA	800-7267	www.samsung.com/lv
	ESTONIA	800-7267	www.samsung.ee
Asia Pacific	AUSTRALIA	1300 362 603	www.samsung.com/au
	New zealand	0800SAMSUNG(726-7864)	www.samsung.com/nz
	CHINA	800-810-5858 , 010-6475 1880	www.samsung.com.cn
	HONG KONG	3698-4698	www.samsung.com/hk
	INDIA	3030 8282 , 1800 110011	www.samsung.com/in
	INDONESIA	0800-112-8888	www.samsung.com/id
	JAPAN	0120-327-527	www.samsung.com/jp
	MALAYSIA	1800-88-9999	www.samsung.com/my
	PHILIPPINES	1800-10-SAMSUNG(726-7864)	www.samsung.com/ph
	SINGAPORE	1800-SAMSUNG(726-7864)	www.samsung.com/sg
	THAILAND	1800-29-3232 , 02-689-3232	www.samsung.com/th
	TAIWAN	0800-329-999	www.samsung.com/tw
VIETNAM	1 800 588 889	www.samsung.com/vn	
Middle East & Africa	Turkey	444 77 11	www.samsung.com.tr
	SOUTH AFRICA	0860-SAMSUNG(726-7864)	www.samsung.com/za
	U.A.E	800-SAMSUNG (726-7864), 8000-4726	www.samsung.com/mea



Contact SAMSUNG WORLD WIDE

If you have any questions or comments relating to Samsung products,
please contact the SAMSUNG customer care center.

 1-800-SAMSUNG (7267864)/www.samsung.com/us

Samsung Electronics America, Inc.
105 Challenger Road
Ridgefield Park, NJ 07660-0511
1-800-SAMSUNG (7267864)
www.samsung.com/us