

The following paragraph does not apply to the United Kingdom or any country where such provisions are inconsistent with local law:

INTERNATIONAL BUSINESS MACHINES CORPORATION PROVIDES THIS PUBLICATION AS IS WITHOUT WARRANTY OF ANY KIND, EITHER EXPRESS OR IMPLIED, INCLUDING, BUT NOT LIMITED TO, THE IMPLIED WARRANTIES OF MERCHANTABILITY OR FITNESS FOR A PARTICULAR PURPOSE.

Some states do not allow disclaimer of express or implied warranties in certain transactions, therefore, this statement may not apply to you.

This publication could include technical inaccuracies or typographical errors. Changes are periodically made to the information herein; these changes will be incorporated in new editions of the publication. IBM may make improvements and/or changes in the product(s) and/or the program(s) described in this publication at any time. It is possible that this publication may contain reference to, or information about, IBM products (machines and programs), programming, or services that are not announced in your country. Such references or information must not be construed to mean that IBM intends to announce such IBM products, programming, or services in your country.

Requests for technical information about IBM products should be made to your IBM reseller or IBM marketing representative.

Thank you for purchasing OPTIONS by IBM. Please take a few moments to register your product and provide us with information that will help IBM to better serve you in the future. Your feedback is valuable to us in developing products and services that are important to you, as well as in developing better ways to communicate with you.

Register your option on the IBM Web site at: <http://www.pc.ibm.com/register>

IBM will send you information and updates on your registered product unless you indicate on the Web site questionnaire that you do not want to receive further information.

**Products Involved:**

<b>Option PN</b>	<b>FRU PN</b>	<b>Description</b>
04K0058	02K3416	Sanyo 32X-14X FRU with Headphone
	02K3418	Hitachi 32X-14X FRU with Headphone
	06H6326	IDE Cable
	00K8155	Audio Cable
	10H2924	Audio Cable
	76H7339	IBM PC Desktop Bezel FRU
	12J4498	IBM PC Tower Bezel FRU

**Safety Information:**



**Electrical current from power, telephone, and communication cables is hazardous. To avoid shock hazard, connect and disconnect cables as shown below when installing, moving or opening the covers of this product or attached devices. The power cord must be used with a properly grounded outlet.**

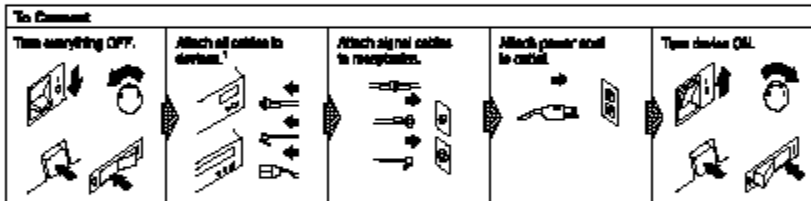

<sup>1</sup> In the U.K., by law, the telephone cable must be connected after the power cord.

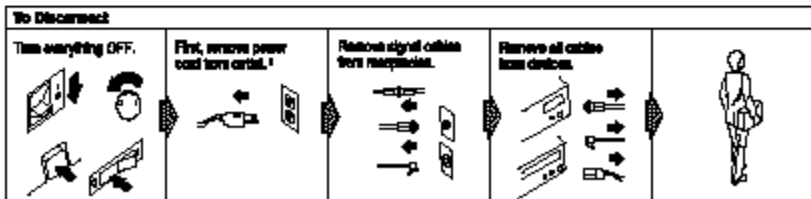

<sup>2</sup> In the U.K., by law, the power cord must be disconnected after the telephone line cables.

To avoid a shock hazard, do not connect or disconnect any cables or perform installation, maintenance, or reconfiguration of this product during an electrical storm.

**To avoid shock hazard:**

- The power cord must be connected to a properly wired and earthed receptacle.
- Any equipment to which this product will be attached must also be connected to properly wired receptacles.



## **DANGER:**

Le courant électrique provenant des câbles d'alimentation, téléphoniques et de transmission peut présenter un danger. Pour éviter tout risque de choc électrique, connectez et déconnectez ces câbles comme indiqué ci-dessous lorsque vous installez ou déplacez ce matériel ou les unités connectées, ou que vous soulevez un cartier.\*

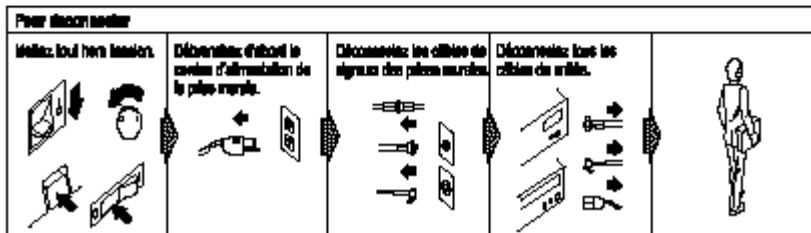
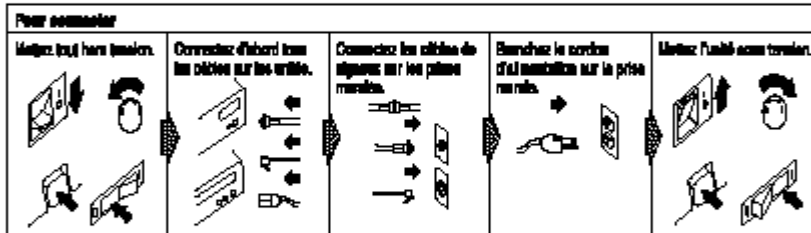

\*Le cordon d'alimentation doit être branché sur un socle de prise de courant correctement mis à la terre.

Pour éviter tout risque de choc électrique, ne manipulez aucun câble et n'effectuez aucune opération d'installation, d'entretien ou de reconfiguration de ce produit au cours d'un orage.

### **Pour éviter tout risque de choc électrique:**

- Le cordon d'alimentation doit être branché sur une prise d'alimentation correctement câblée et mise à la terre.
- D'autre part, tout le matériel connecté à ce produit doit également être branché sur des prises d'alimentation correctement câblées et mises à la terre.



## PELIGRO:

La corriente eléctrica de la alimentación, teléfono y cables de comunicación es peligrosa. Para evitar peligro de descargas cuando instale, mueva o abra las cubiertas de este producto o de un disp. conectado, conecte y desconecte los cables tal como se muestra a continuación.

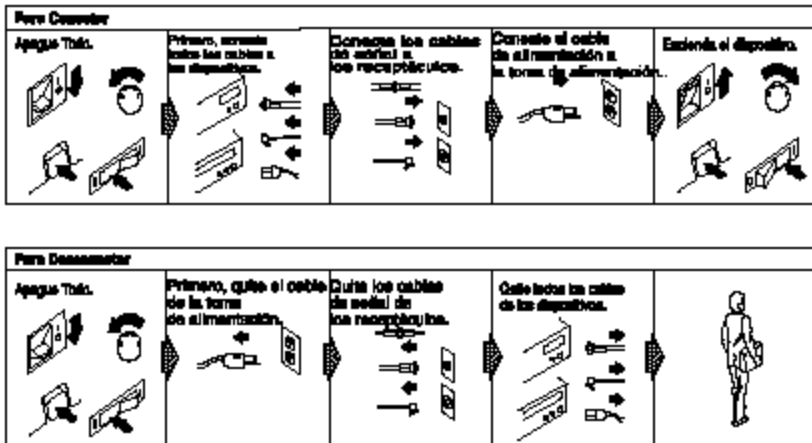

Para evitar peligro de descargas, no conecte o desconecte ningún cable, ni realice ninguna instalación, mantenimiento o reconfiguración de este producto durante una tormenta eléctrica.

### Para evitar peligro de descargas:

- El cable de alimentación debe estar conectado a una toma de alimentación adecuadamente cableada y con toma de tierra.
- Cualquier equipo al cual se conecte este producto debe estar también conectado a tomas de alimentación adecuadamente cableadas.

Cuando sea posible, utilice una mano para conectar o desconectar los cables de señal para impedir que se produzcan posibles descargas eléctricas al tocar dos superficies con potencial eléctrico distinto.

## DANGER!

### Quick Installation Guide:

The IBM 32X-14X Internal IDE CD-ROM Drive can read a compact disc (CD) containing approximately 680 MB of information.

The drive delivers data at up to 32 times the standard CD-ROM speed, delivering data at up to 4800 KB per second. The CD-ROM drive is designed for installation in a personal computer that uses the integrated drive electronics (IDE) or the enhanced IDE architecture. The drive may be mounted vertically or horizontally. For more detailed installation instructions, go to User's Guide.

In addition to this book, the option package includes:

- IBM 32X-14X Internal IDE CD-ROM Drive
- Two audio cables
- Four mounting screws (M3 x 5 mm, slotted)
- IDE cable for connecting two IDE devices
- Two faceplates for use with certain systems
- IBM 32X-14X Internal IDE CD-ROM Drive Option Diskette

## - Laser Safety Guide for CD-ROMs

Contact your place of purchase if an item is missing or damaged. Be sure to retain your proof of purchase. It might be required to receive warranty service. See Help and Service Information for technical support information.

### **Installing the Drive:**

#### **Opening the Computer:**

1. Turn off the computer and all attached peripherals.
2. Unplug the power cords for the computer and all attached devices.
3. Remove the cover from the computer.

#### **Unpacking the Drive:**

1. In order to discharge any accumulated static electricity, touch an unpainted metal surface for at least two seconds.
2. Take the bag the drive is packed in and touch it to an unpainted metal surface for at least two seconds.
3. Remove the drive from the bag.

If you must put the drive down, place the antistatic bag on a flat padded surface, such as a magazine, and place the drive on the bag with the component side facing up.

#### **Selecting an IDE Port:**

Newer computers typically have two IDE ports. If your computer has two IDE ports, use the secondary IDE port to connect the CD-ROM drive. Typically the secondary IDE port is adjacent to the primary IDE port that connects to your hard disk drive.

The IDE port you select and the cable position you select will determine which configuration jumper setting you will use for the drive. See Setting the Configuration Jumper for instructions on setting the configuration jumper.

If you have two IDE ports, connect the CD-ROM drive to the secondary IDE port with the IDE cable that comes with your drive. If the CD-ROM drive is the only device on the secondary IDE port, you will use the master configuration setting. If there is another device on the secondary port in addition to the CD-ROM drive, you will use the slave configuration setting.

If you must attach the CD-ROM drive to the same IDE port as a faster device, such as a hard disk drive, you will use the slave setting for the CD-ROM drive and the master setting for the faster device. In some instances, the hard disk drive may require a master-with-slave-present setting when another device on the same cable is configured as a slave. For further information on setting configuration jumpers on other devices, refer to the documentation that came with your system or with the device in question.

Some non-IBM computers support the cable-select setting, where the position of the device on the cable determines whether a device is master or slave. See the documentation that comes with your computer to determine if your system supports this setting.

#### **Setting the Configuration Jumper:**

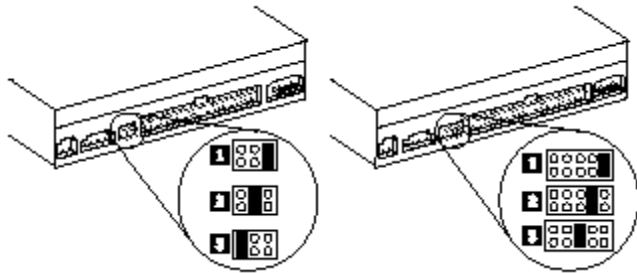

The illustration above shows the master **1** setting, the slave **2** setting, and the cable-select **3** setting. Configure the CD-ROM drive by placing a jumper over one pair of pins. If your CD-ROM drive has three pairs of pins, refer to the illustration above left to set the jumper. If your drive has five pairs of pins, disregard the first two pairs, as they are for factory use only. The jumper setting positions for the last three pairs of pins are shown in the illustration, above right.

If you are configuring the CD-ROM drive as master, set the jumper to the master **1** device setting. (This is how the drive is set when it is shipped.) If there is a second device on the IDE port, check that the device is configured as slave.

If you are configuring the CD-ROM drive as slave, set the jumper to the slave **2** device setting. Check that the other device on the IDE port is configured as master (or master-with-slave-present).

If you are configuring the CD-ROM drive as cable-select, set the jumper to the cable-select **3** device setting. If there is another device on the IDE port, check that the device is also configured for cable-select.

### Mounting the Drive in the Bay:

Attention: Be sure to use the M3 x 5 mm mounting screws in the option package when you are driving screws directly into the drive. Using screws that are too long might damage the drive. You can mount the CD-ROM drive either horizontally or vertically in the computer. If you mount the drive vertically, you must secure any CDs you place into the drive before the drive tray is closed, or the CD-ROM drive will not be able to read the CD properly.

1. Slide the drive into the bay. Your system may have specific required procedures for installing storage devices. Refer to the documentation that came with your system for further instructions.
2. Align the drive-bay screw holes with the threaded holes in the drive housing or mounting bracket. Be sure to use the M3 x 5mm mounting screws provided with this drive. Using the wrong size screws might damage the drive.
3. Thread the screws in loosely to check their position. Usually two screws are used on each side. Check to make sure the alignment is correct, then tighten the screws to secure the drive. Do not overtighten.

### Attaching the Cables to the Drive:

1. Connect the cables to the CD-ROM drive as follows:

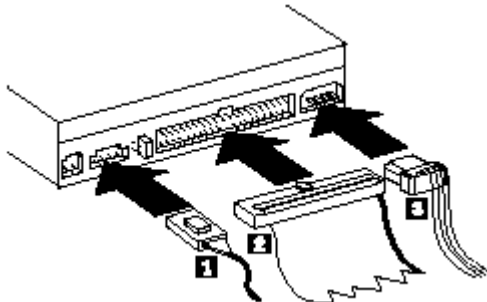

- a. Attach a 40-pin IDE-cable connector **2** to the IDE connector on the drive. Align the cable so that the color-coded edge is closest to the power cable connector **3**. Use the IDE cable provided with this option if there is no cable attached to the IDE port or if there is only one device connector on the IDE cable.
- b. Attach a four-pin power-cable connector **3** to the device dc-power connector.
- c. If you have a sound adapter, connect one of the audio cable connectors **1** to the device audio-out connector. Use the audio cable that has a connector that fits your sound adapter and save the other cable in case you use a different sound adapter in the future.

#### **Attaching the Faceplates:**

This option package includes two faceplates which conform to the curved design of certain IBM systems. If your computer system has a curved design, you may attach one of the included faceplates so that the front of the CD-ROM drive matches the exterior cabinet. Choose the faceplate that best fits your system, and attach it after you have mounted the CD-ROM drive in the appropriate bay. The bezel will not be used with all IBM systems.

#### **Completing the Hardware Installation:**

1. Be sure that the drive is securely mounted and the connectors are firmly attached.
2. Be sure the cables do not interfere with the computer cover and do not block the power-supply fan blades or air-flow paths.
3. Reinstall the computer cover.
4. Reconnect all devices and check any devices that might have become disconnected, such as the keyboard, mouse, and monitor.
5. Plug all power cords into electrical outlets.

#### **Updating Your Computer Configuration:**

Because you changed the hardware, the configuration-setup information screen should display when you turn on your computer. If you don't see this screen, check your computer documentation for information about accessing the configuration or setup utility program.

To see the configuration information for most IBM computers, press F1 during startup when the graphic displays in the upper right corner of the screen. When you have finished reviewing the information, save the changes and exit.

Note: Some older computers with one IDE port might not display the CD-ROM drive information when you review the configuration-setup information. You still can use the CD-ROM drive in this situation as long as you have properly completed the installation.

#### **Installing Device Drivers:**

This section contains the instructions for installing device drivers for the CD-ROM drive, based on the operating system you are using. Go to the section which corresponds to your operating system. Note: User requirements vary; if you are using DOS or OS/2 as your operating system, the device driver settings for those operating systems can be customized. If your system does not work well with the default settings given in the installation instructions in this section, please refer to Customizing Device Driver Configuration Settings for information on how to customize your device driver configuration settings. View the README file on the 32X-14X Internal IDE CD Rom Drive Option Diskette for additional notes that were not available when this manual

was created. You may view the file on-line if you run CDSETUP from the 32X-14X Internal IDE CD Rom Drive Option Diskette.

**Installing the Device Driver for Windows 95:**

In most instances, Microsoft Windows 95 will automatically detect the CD-ROM drive. If the CD-ROM drive is automatically detected, Windows 95 will then use the device drivers which are included with the operating system, and you will not need to install the drivers on the Option Diskette. If Windows 95 is in 32-bit mode for IDE, the CD-ROM drive will be recognized by the operating system. Otherwise, follow the instructions on your screen to install the device drivers from the Option Diskette.

**Installing the Device Drivers for DOS, DOS with Windows 3.X, Windows 95 in MS-DOS mode, or OS/2 Warp version 3.0 or Higher:**

1. Go to a command line.
2. Insert the Option Diskette into drive A.
3. Type in A:CDSETUP, then press Enter.
4. Using your mouse or the arrow keys, select Setup.
5. Follow the instructions on your screen to properly install the driver.
6. When setup is complete, select Exit.
7. You will be prompted to restart your system; the changes will not take effect until you do so.

Note: To resolve resource conflicts or if you need options that are not found in the CDSETUP device-driver installation program, refer to the READ.ME file on the Option Diskette. If you have problems installing the device driver, refer to the CDSETUP program help information.

**Installing the Device Driver for Windows NT 3.51:**

1. Start Windows.
2. Click on the Start button and open the Main folder.
3. Click on Control Panel.
4. Double-click on Devices.
5. Click on atapi.
6. Click on Startup.
7. Click on Boot.
8. Click on OK.
9. Click on Cdfs.
10. Click on Startup.
11. Click on System.
12. Click on OK.



13. Click on Close.
14. Close the Control Panel.
15. Shut down and restart the computer.

See the Windows NT installation guide for more information.

#### **Installing the Device Driver for Windows NT 4.0:**

Windows NT version 4.0 should automatically detect the presence of the IDE CD-ROM drive. No additional steps are required to activate the device drivers.

Some IBM Windows NT pre-loads contain a piixide device driver. This device driver replaces the Windows NT native atapi device driver, and provides DMA support. The IDE CD-ROM will not work if both the atapi and piixide device drivers are enabled at the same time. If this occurs, go into the Control Panel and set the Startup parameter of one of the drivers to Disabled.

#### **User's Guide:**

##### **Product Description:**

The IBM 32X-14X Internal IDE CD-ROM Drive can read a compact disc (CD) containing approximately 680 MB of information. It is designed for installation in a personal computer that uses the integrated drive electronics (IDE) or the enhanced IDE architecture.

The CD-ROM drive delivers data up to 32 times the standard CD-ROM speed, delivering data at up to 4800 KB per second. The drive reads compact discs meeting the ISO-9660 and High-Sierra Group (HSG) standards. It also reads multiple-session, extended architecture (XA) discs, such as the Kodak Photo CD.

In addition to this book, the option package includes:

- IBM 32X-14X Internal IDE CD-ROM Drive.
- Two audio cables.
- Four mounting screws (M3 x 5 mm, slotted.)
- Two system faceplates.
- 32X-14X Internal IDE CD-ROM Drive Option Diskette.
- IDE cable for connecting two IDE devices.
- Laser Safety Guide for CD-ROMs.

Contact your place of purchase if an item is missing or damaged. Be sure to retain your proof of purchase. It might be required to receive warranty service. The Option Diskette includes installation and support programs, such as:

- Installation programs for DOS, Windows, and OS/2
- IDE CD-ROM device drivers.
- Audio CD-player program for DOS.
- READ.ME file with additional installation information.
- Diagnostic program.

You can find information on how to get help, technical support, and warranty service in Appendix D, Help and Service Information on page 3-24.

### Front View of the Drive

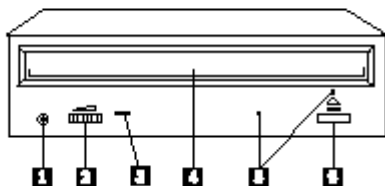

- 1 - Headphone jack. This jack provides audio output to the headphones.
  - 2 - Volume control. This controls the audio output volume.
  - 3 - Busy indicator. This light comes on when the drive reads a data CD or plays an audio CD.
  - 4 - CD tray. This is where you load and unload a CD.
  - 5 - Manual-eject hole. This provides access to the manual eject mechanism to remove a CD from the drive.
- Note: Your CD-ROM drive will have a manual-eject hole in one of the positions in the illustration, but not both.
- 6 - Eject/Load button. Opens and closes the CD tray.

### Back View of the Drive

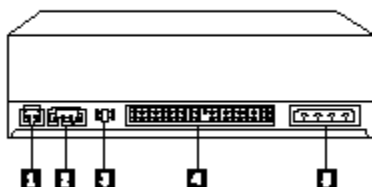

- 1 - Reserved.
- 2 - Audio-out connector. Connects the analog audio signals to a sound adapter.
- 3 - Configuration pins. Sets the drive configuration.
- 4 - IDE connector. Connects the CD-ROM drive to the IDE cable.
- 5 - DC power connector. Connects the dc power cord to the CD-ROM drive.

### Before You Begin:

Read the following information before you start your installation. The installer of the drive will have to complete the following steps:

- Determine which IDE port to use, and the corresponding configuration setting.
- Set the configuration jumper on the drive (and possibly make changes to the configuration settings of other devices.)
- Physically install the drive in a drive bay.
- Configure the system.
- Install a device driver.

If you do not understand these procedures, or are unsure about your ability to perform all the procedures described, have a qualified computer technician install the CD-ROM drive for you, or call an IBM technical-support representative.

### Installation Requirements:

Before you begin installing the drive, be sure you have everything you need, such as:

### Documentation:

You might need the documentation that comes with your computer, operating system, or IDE bus adapter if it is separate from the computer.

### Minimum Processor:

IBM Personal Computer or compatible computer with an 80486 processor (or later version).  
640 KB RAM (random-access memory) for DOS 3.3 (or later) and 4 MB RAM for Windows 3.1 (or later).  
3.5-inch, 1.44 MB or 2.88 MB diskette drive  
IDE port and cable  
The CD-ROM drive requires an IDE interface to your computer.

The IDE port is on the system board of the computer or on an IDE bus adapter. Newer computers typically have two IDE ports on the system board adjacent to one another. The primary IDE port is usually connected to your hard disk drive. (If the interface cable connector has 40 pins, your computer uses the IDE architecture.)

If your computer has one IDE port, you can attach a maximum of two devices. If your computer has a primary and a secondary IDE port, you can attach up to two devices to each port for a maximum of four devices.

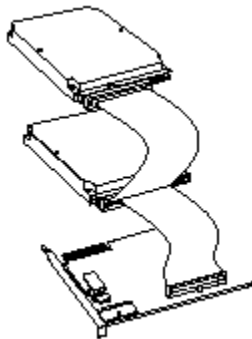

The CD-ROM drive connection requires an available connector on the IDE cable. If the computer has two IDE ports, examine the cables on both ports for an available connector. If your IDE cables have only one connector, you can replace one of the cables with the two-connector cable included in this option package. If you have more than one IDE port, attach hard disk drives to the cable on the primary IDE port. Attach slower devices, such as CD-ROM and tape drives, to the cable on the secondary port. Some computers come with a dual-port, high-performance IDE controller.

Connecting the CD-ROM drive to the secondary IDE port provides better operating system performance. If you are attaching the CD-ROM drive to the same port as another device, such as a hard disk drive or tape drive, refer to the documentation for that device to see if there are any special requirements or settings. Some devices, such as a high speed tape drive, must not be installed on the same port as a CD-ROM drive.

**Power connector:**

To provide power to the CD-ROM drive, you need an unused 4-pin dc-power connector on the cable coming from the computer power supply. If all power cables are in use, purchase a dc Y-connector (available at most electronic stores) and split a connection to add a power connector.

**CD-ROM drive mounting:**

The CD-ROM drive installs in an accessible vertical or horizontal 5.25-inch mounting bay. You might need both a flat-blade and a Phillips-head screwdriver for the installation.

**Operating system:**

The installation instructions are written for the following operating systems.

- Microsoft Windows NT 3.51 or later.
- Microsoft Windows 3.0 or later (DOS 6.0 or later).
- Windows 95.
- OS/2 3.0 or later (you might need the installation diskettes).

- Device Handling Precautions.

To protect your CD-ROM drive during installation, observe the following precautions. Handle the drive with care. Dropping or jarring the drive can damage the components inside the drive housing. Keep the CD-ROM drive in its antistatic bag until you are ready to install the drive in your computer. Limit your movement. Movement can cause static electricity buildup.

To protect your CD-ROM drive during operation, observe the following precautions:

- Remove any CD in the drive before moving the drive.
- Do not insert foreign objects into the drive.
- Do not stack objects on the drive.
- Do not remove the drive cover or attempt to service the drive.
- Do not operate the drive under any of the following conditions:
  - High temperature, high humidity, or direct sunlight.
  - Excessive vibration, sudden shock, or inclined surface.
  - Excessive dust.

**Installing the Drive:**

**Opening the Computer:**

1. Turn off the computer and all attached peripherals.
2. Unplug the power cords for the computer and all attached devices.
3. Remove the cover from the computer.

**Unpacking the Drive:**

1. In order to discharge any accumulated static electricity, touch an unpainted metal surface for at least two seconds.
2. Take the bag the drive is packed in and touch it to an unpainted metal surface for at least two seconds.
3. Remove the drive from the bag.

If you must put the drive down, place the antistatic bag on a flat padded surface, such as a magazine, and place the drive on the bag with the component side facing up.

**Selecting an IDE Port:**

Newer computers typically have two IDE ports. If your computer has two IDE ports, use the secondary IDE port to connect the CD-ROM drive. Typically the secondary IDE port is adjacent to the primary IDE port that connects to your hard disk drive. The IDE port you select and the cable position you select will determine which configuration jumper setting you will use for the drive. See 'Setting the Configuration Jumper' for instructions on setting the configuration jumper.

If you have two IDE ports, connect the CD-ROM drive to the secondary IDE port with the IDE cable that comes with your drive. If the CD-ROM drive is the only device on the secondary IDE port, you will use the master configuration setting. If there is another device on the secondary port in addition to the CD-ROM drive, you will use the slave configuration setting.

If you must attach the CD-ROM drive to the same IDE port as a faster device, such as a hard disk drive, you will use the slave setting for the CD-ROM drive and the master setting for the faster device. In some instances, the hard disk drive may require a master-with-slave-present setting when another device on the same cable is configured as a slave. For further information on setting configuration jumpers on other devices, refer to the documentation that came with your system or with the device in question.

Some non-IBM computers support the cable-select setting, where the position of the device on the cable determines whether a device is master or slave. See the documentation that comes with your computer to determine if your system supports this setting.

### Setting the Configuration Jumper:

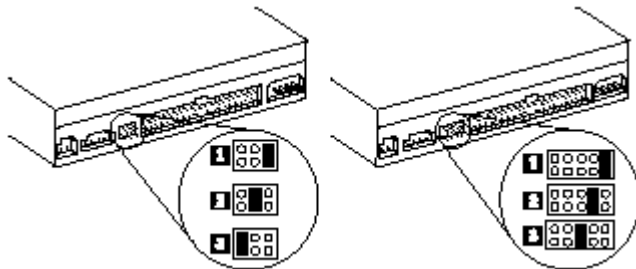

Configure the CD-ROM drive by placing one jumper over a set of configuration pins. If your CD-ROM drive has three pairs of pins, refer to the illustration above left to set the jumper. If your drive has five pairs of pins, disregard the first two pairs, as they are for factory use only. The jumper setting positions for the last three pairs of pins are shown in the illustration, above right.

If you are configuring the drive as master, set the jumper to the master **1** device setting. (This is how the drive is set when it is shipped.) If there is a second device on the IDE port, check that the device is configured as slave.

If you are configuring the drive as slave, set the jumper to the slave **2** device setting. Check that the other device on the IDE port is configured as master (or master-with-slave-present).

If you are configuring the drive as cable-select, set the jumper to the cable-select **3** device setting. If there is another device on the IDE port, check that the device is also configured for cable-select.

If you need assistance in setting the configuration jumpers or need additional information about the hard disk drive on the same IDE port as the CD-ROM drive, refer to Hard Disk Drive Manufacturers.

### Mounting the Drive in the Bay:

Attention: Be sure to use the M3 x 5 mm mounting screws in the option package when you are driving screws directly into the drive. Using screws that are too long can damage the drive. Mount the CD-ROM drive horizontally or vertically in the computer.

If you mount the drive vertically, you must secure any CDs you place into the drive before the drive tray is closed, or the CD-ROM drive will not be able to read the CD properly. For further instructions on securing your CDs in a vertically mounted drive, go to page 2-12.

1. Slide the drive into the bay. Your system may have specific required procedures for installing storage devices. Refer to the documentation that came with your system for further instructions.
2. Align the drive-bay screw holes with the threaded holes in the drive housing or mounting bracket. Be sure to use the M3 x 5mm mounting screws provided with this drive. Using the wrong size screws might damage the drive.
3. Thread the screws in loosely to check their position. Usually two screws are used on each side. Check to make sure the alignment is correct, then tighten the screws to secure the drive. Do not overtighten.

### Attaching the Cables to the Drive:

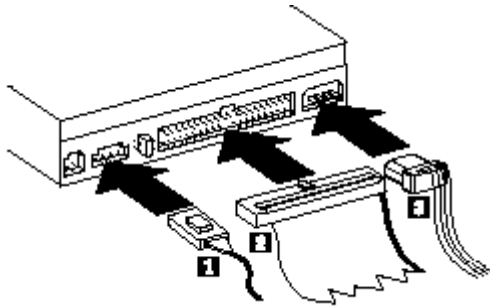

Connect the cables to the CD-ROM drive according to the following instructions. Refer to the illustration below if you have difficulty locating any of the connections.

1. Attach a 40-pin IDE-cable connector **2** to the IDE connector on the drive. Align the cable so that the color-coded edge is closest to the power cable connector **3**. Use the IDE cable provided with this option if there is no cable attached to the IDE port or if there is only one device connector on the IDE cable.
2. Attach a four-pin power-cable connector **3** to the device dc-power connector.
3. If you have a sound adapter, connect one of the audio cable connectors **1** to the device audio-out connector. Use the audio cable that has a connector that fits your sound adapter and save the other cable in case you use a different sound adapter in the future.

### Attaching the Faceplates:

This option package includes two faceplates which conform to the curved design of certain IBM systems. If your computer system has a curved design, you may attach one of the included faceplates so that the front of the CD-ROM drive matches the exterior cabinet. Choose the faceplate that best fits your system, and attach it after you have mounted the CD-ROM drive in the appropriate bay. The bezel will not be used with all IBM systems.

### Completing the Hardware Installation:

To complete the hardware section of the CD-ROM drive installation:

1. Be sure that the drive is securely mounted and the connectors are firmly attached.
2. Be sure the cables do not interfere with the computer cover and do not block the power-supply fan blades or air-flow paths.
3. Reinstall the computer cover.
4. Reconnect all devices and check any devices that might have become disconnected, such as the keyboard, mouse, and monitor.
5. Plug all power cords into electrical outlets.

### Updating the Configuration:

Because you changed the hardware, the configuration-setup information screen should display when you turn on your computer. If you don't see this screen, check your computer documentation for information about accessing the configuration or setup utility program.

To see the configuration information for most IBM computers, press F1 during startup when the graphic displays in the upper right corner of the screen. When you have finished reviewing the information, save the changes and exit.

Note: Some older computers with one IDE port might not display the CD-ROM drive information when you review the configuration-setup information. You still can use the CD-ROM drive in this situation as long as you have properly completed the installation.

### **Installing Device Drivers:**

This section contains the instructions for installing device drivers for the CD-ROM drive, based on the operating system you are using. Go to the section which corresponds to your operating system. Note: User requirements vary; if you are using DOS or OS/2 as your operating system, the device driver settings for those operating systems can be customized. If your system does not work well with the default settings given in the installation instructions in this section, please refer to Customizing Device Driver Configuration Settings for information on how to customize your device driver configuration settings.

- If you are using Windows 95, go to Installing the Device Driver for Windows 95.
- If you are using DOS, DOS with MicroSoft Windows 3.X, Windows 95 in DOS mode, or OS/2, go to Installing the Device Driver for DOS, DOS with Windows 3.X, or OS/2 3.0 and Higher.
- If you are using Windows NT 3.51, go to Installing the Device Driver for Windows NT 3.51.
- If you are using Windows NT 4.0, go to Installing the Device Driver for Windows NT 4.0.
- If you are using another operating system, see the documentation that comes with your computer and operating system.

Then, go to Using the Drive.

### **Installing the Device Driver for Windows 95:**

In most instances, Microsoft Windows 95 will automatically detect the CD-ROM drive. If the CD-ROM drive is automatically detected, Windows 95 will then use the device drivers which are included with the operating system, and you will not need to install the drivers on the Option Diskette. If Windows 95 is in 32-bit mode for IDE, the CD-ROM drive will be recognized by the operating system. Otherwise, follow the instructions on your screen to install the device drivers from the Option Diskette.

### **Installing the Device Driver for DOS, DOS with Windows 3.X, or OS/2 3.0 and Higher:**

1. Go to a command prompt.
2. Insert the Option Diskette into drive A.
3. Type the letter of the drive, a colon, and CDSETUP (such as, A:CDSETUP), then press Enter.
4. CDSETUP will present a menu of options:
  - SETUP: This option will install the appropriate device drivers.
  - CDDIAG: This is a diagnostic program which will test your IDE CD-ROM drive.
  - README: This contains information about situations which are not covered by these installation instructions.
  - HELP: This provides information about how to use the SETUP program.
  - EXIT: This returns you to the command prompt or main screen of your operating system.
5. From the CDSETUP menu, use your mouse or the arrow keys to select the SETUP option.
6. Follow the instructions on your screen to properly install the device driver.
7. When setup is completed, select the EXIT option to exit the CDSETUP program.
8. You will need to restart your computer in order for the changes to take effect.

Note: To resolve resource conflicts or if you need options that are not found in the CDSETUP device-driver installation program, refer to the READ.ME file on the Option Diskette. If you have problems installing the device driver, refer to the CDSETUP program help information.

#### **Installing the Device Driver for Windows NT 3.51:**

1. Start Windows.
2. Click on the Start button and open the Main folder.
3. Click on Control Panel.
4. Double-click on Devices.
5. Click on atapi.
6. Click on Startup.
7. Click on Boot.
8. Click on OK.
9. Click on Cdfs.
10. Click on Startup.
11. Click on System.
12. Click on OK.
13. Click on Close.
14. Close the Control Panel.
15. Shut down and restart the computer.

See the Windows NT installation guide for more information.

#### **Installing the Device Driver for Windows NT 4.0:**

Windows NT version 4.0 should automatically detect the presence of the IDE CD-ROM drive. No additional steps are required to activate the device drivers.

Some IBM Windows NT pre-loads contain a piixide device driver. This device driver replaces the Windows NT native atapi device driver, and provides DMA support. The IDE CD-ROM will not work if both the atapi and piixide device drivers are enabled at the same time. If this occurs, go into the Control Panel and set the Startup parameter of one of the drivers to Disabled.

#### **Using the Drive:**

This section includes instructions for the proper care of CDs and the care and operation of your CD-ROM drive.

#### **Caring for a CD:**

CDs are high-density media that must be handled with care and kept clean to insure that they remain readable. These precautions will help to prolong the life of your CDs. Attention: Wiping a CD using a circular motion can cause loss of data.



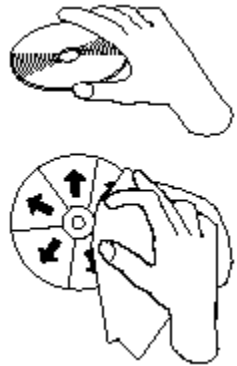

- Handle the CD by the edges or the center hole. Do not touch the surface of the CD.
- To remove dust or fingerprints, wipe the CD from the center to the edge with a soft, lint-free cloth.
- Do not write on the surface.
- Do not place the CD in direct sunlight.
- Do not use commercial cleaners to clean the CD.
- Do not bend the CD.
- Loading a CD

To load a CD into a drive in a horizontal bay :

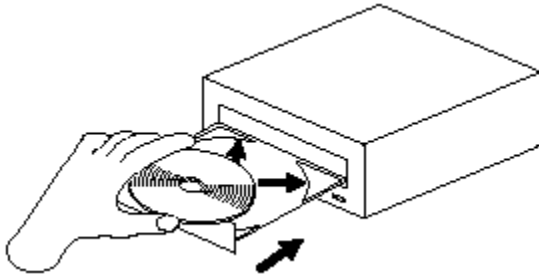

1. Press the Eject/Load button. The tray slides out of the drive.
2. Place the CD in the tray with the label facing up.
3. Close the tray by pressing the Eject/Load button, or by gently pushing the tray in.

Attention: Do not force the tray to open; do not insert foreign objects into the CD tray. If you have mounted your CD-ROM drive in a vertical bay, consult the following illustration to determine which kind of loading tray your drive has.

- If it looks like the figure on the left, go to Securing a CD in a Tray with Rotating Clips.
- If it looks like the figure in the middle, go to Securing a CD in a Tray with a Metal Rod.
- If it looks like the figure on the right, go to Securing a CD in a Tray with Pullout Clips.

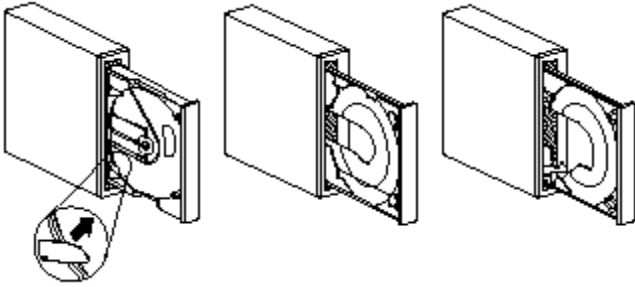

### **Securing a CD in a Tray with Rotating Clips:**

The drive tray pictured on the left has four plastic clips which rotate over the edges of the CD-ROM or audio CD and hold it in place when the drive is mounted vertically.

1. Push the Eject/Load button to open the loading tray.
2. Place your CD into the loading tray.
3. Using your fingernail or something similar, gently rotate the clips toward the center of the tray until they cover the edges of the CD.
4. Close the tray, either by pushing the Eject/Load button again, or by gently pushing on the tray.

### **Securing a CD in a Tray with Pullout Clips:**

The drive on the right of the illustration has clips that pull out to hold the CD in place.

1. Push the Eject/Load button to open the loading tray.
2. Place your CD into the loading tray.
3. Using your fingernail or something similar, gently pull the clips out, toward the center of the tray, until they cover the edges of the CD.
4. Close the tray, either by pushing the Eject/Load button again, or by gently pushing on the tray.

### **Securing a CD in a Tray with a Metal Rod:**

This kind of drive tray does not have clips to hold the CD. Instead, a small metal rod holds the CD or CD-ROM in place when the drive is vertically mounted. When you first unpack your CD-ROM drive, the metal rod will be in the storage position, located on the side of the tray. If the drive is mounted horizontally, this storage position keeps the rod out of the way. In order to use the rod to hold in your CDs, you must follow these instructions.

**Attention:** If your CD-ROM drive has a small metal rod attached to the side of the loading tray, and you do not follow these instructions, your CD or CD-ROM will not be inserted properly and will not be read correctly by the drive.

1. Locate the small metal rod on the side of the CD-ROM drive.
2. Remove the wire rod by unclipping each end from its housing.
3. Decide which side of the CD-ROM drive tray will be pointing down after the drive is vertically mounted.

4. If the right side of the tray will be facing down, reclip each end of the rod into the pinholes on the right side of the tray. If the left side of the tray will be facing down, reclip each end of the rod into the pinholes on the left side of the tray.
5. When properly inserted, the rod will already be in the closed position. You will see a small spring-loaded section on the front part of the tray, which allows the rod to be pulled up. To insert your CD, gently pull the rod up.
6. After placing your CD into the tray, ease the rod back into place over the CD.
7. Close the loading tray, either by pushing the Eject/Load button again, or by gently pushing on the tray.

If you have mounted the drive vertically, and then change the mounting position to horizontal, you must remove the metal rod from the spring-loaded section and the opposing pinhole, and return the rod to the storage position on the side of the tray. If you do not do this, the rod might interfere with the drive's ability to read the CD-ROM correctly.

#### **Manually Ejecting a CD:**

If you press the Eject/Load button and the tray does not slide out, turn off the computer and straighten a large paper clip to form a tool, as shown in the illustration. The straightened end must extend at least 45 mm (1.8 in.). Insert the extended end into the manual-eject hole on the front of the drive (see Front View of the Drive on page 2-2). Push the paper clip until the tray opens. Gently pull out the tray until you can remove the CD.

#### **Playing an Audio CD:**

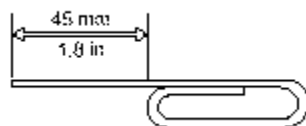

To play an audio CD, you must have an audio-CD program installed in your computer. If you are using the IBM 32X-12X Internal IDE CD-ROM Drive with DOS, there is a program included on the Option Diskette that will allow you to play audio CDs. Windows 3.x, Windows 95, Windows NT, and OS/2 all come with multimedia extensions that include audio-CD player programs.

Follow the procedures below which correspond to your operating system. For more information on using your audio playback software, see the documentation that comes with your operating system or your computer.

#### **DOS:**

The DOS operating system does not have a built-in program for playing audio CDs. In order for you to listen to audio CDs using DOS, you must use the program which is provided on your Option Diskette, called IBMCDPLY.EXE. Use the following instructions to use the program.

1. First make sure that you have correctly installed the device drivers for the IBM 32X-14X Internal IDE CD-ROM Drive. For further instructions on installing the device drivers, refer to Installing Device Drivers.
2. Once you have installed the device drivers, the DOS audio playback software will also be installed on your hard disk drive.
3. Go to a command prompt.
4. Type in `IBMCDPLY` and hit `Enter`.

5. The program will execute, and a graphic will appear on your screen which looks like the control panel of a CD player. The controls are labeled with text below each icon. Use your mouse to select the control you want to use.

6. To exit the program, push the F3 key.

### **Windows 3.X:**

To use the Windows audio utility:

1. Turn on the computer.
2. Load an audio CD into the CD tray.
3. Double-click on Accessories.
4. Double-click on Media Player, and then on Device.
5. Click on CD Audio.

If you do not see the Media Player icon or the CD Audio icon within the Media Player folder, you must install the Windows CD Audio device driver as follows:

1. From the Program Manager select the Main folder.
2. Select Control Panel; then select Drivers. Select MCI CD Audio if it is not already installed. Follow the instructions on the screen.

If you select New, you will need your Windows 3.X diskettes. If you select Current, continue with the instructions on the screen.

### **Windows 95:**

To use the Windows 95 audio utility:

1. Turn on the computer.
2. Load an audio CD into the CD tray.
3. Click on the Start button.
4. Move the cursor up to Programs, then to Accessories, then to Multimedia, then to Media Player.
5. When the Media Player window opens, double-click on the Media Player icon.
6. Double-click on Device.
7. Double-click on CD Audio.

If you do not see the Media Player or CD Audio icons within the Media Player folder, you must install the Windows CD Audio device driver as follows:

1. Double-click on the My Computer icon, then on Control Panel, then on the Multimedia icon. Next, click on the Advanced tab. Double-click on Media Control Devices, then on CD Audio Devices.
2. Make sure that the CD device driver is enabled. If the driver is not present or is disabled, install the driver.

**OS/2 Warp:**

To use the OS/2 audio utility:

1. Turn on the computer.
2. Load an audio CD into the CD tray.
3. Open Multimedia.
4. Select and start Compact Disc.

**Using a Data CD:**

You can use a data CD to read data files, play games, or run applications. The instructions to use a data CD depend on your operating system.

**DOS:**

To read a data CD:

1. Turn on the computer. The operating system displays the following messages (drive D is the CD-ROM drive in this example):  
MSCDEX Version 2.2.3  
Copyright (c) Microsoft Corp. 1986-1993  
Drive D:=Driver IBMCD1 unit

2. Load a data CD into the CD tray.
3. At the DOS prompt, type dir d:, and press Enter.
4. Verify that you can view the files on the CD.

**Windows 3.X and Windows NT 3.51:**

To read a data CD:

1. Turn on the computer.
2. Load a data CD into the CD tray.
3. Double-click on File Manager.
4. Verify that the CD icon is displayed.
5. Double-click on CD-ROM.
6. Verify that you can view files on the CD.

**Windows 95 and Windows NT 4.0:**

To read a data CD:

1. Turn on the computer.
2. Load a data CD into the CD tray.
3. Click on My Computer.
4. Verify that the CD icon is displayed.
5. Click on CD-ROM.

6. Verify that you can view files on the CD.

### **OS/2 Warp:**

To read a data CD:

1. Turn on the computer.
2. Load a data CD into the CD tray.
3. Double-click on OS/2 System and then Drive.
4. Verify that the CD icon is displayed.
5. Double-click on CD.
6. Verify that you can view files on the CD.

### **Customizing Device Driver Configuration:**

This section contains optional device driver configuration information for DOS with Windows, OS/2, and Windows 95. Use the online help during the installation and refer to the READ.ME file on the IBM 32X-14X Internal IDE CD-ROM Drive Option Diskette for additional information.

### **DOS with Windows Software:**

User requirements vary, and you might need to customize the setup which CDSETUP has installed on your computer. This section provides information and describes parameters that you might need to change or add for your installation.

### **Device Driver (IBMIDEC.DSYS):**

Most computers will function adequately with the default settings for this file. However, there are some parameters that can be changed if necessary. This section explains the function of each parameter. Use a text editor to modify the appropriate line in your CONFIG.SYS file. For the IBMIDEC.DSYS device driver, the line in CONFIG.SYS is in the following format:

```
DEVICE=[drive:][path]IBMIDEC.DSYS /D:device name  
      [/P:xxx,yy] [/A:n] [/D:n]  
      [/L:xx] [/T:n] [/I:n]
```

Do not truncate the actual device driver entry. Place the complete DEVICE= on one line in the CONFIG.SYS file.

```
[drive:][path]IBMIDEC.DSYS
```

The above parameter specifies the location (drive and directory) and name of the device driver file. Use the following options to configure the device driver.

**/D:device name** specifies the device name of the CD-ROM drive. This must be identical to the device name specified in the MSCDEX.EXE parameters, for example:

```
DEVICE=C:\IBMIDEC.DSYS /D:EMCDE
```

**/P:xxx,yy** specifies the address and interrupt level of the port to which the IDE CD-ROM drive is connected. The device driver automatically checks the industry standard primary IDE port (address 1F0, interrupt 14) and secondary IDE port (address 170, interrupt 15). The /P parameter is not needed if your CD-ROM drive is on either of these ports.

However, if your computer (or IDE adapter) uses different IDE port addresses or interrupts, you must use this option. Refer to the instructions that come with your computer or IDE adapter to understand how your computer or adapter is configured.

**xxx** is the base address of the IDE port.  
1F0 for the primary IDE port (Port 1)  
170 for the secondary IDE port (Port 2)

**yy** is the interrupt (IRQ) level.  
14 for the primary IDE port (Port 1)  
15 or 10 for the secondary IDE port (Port 2)

As an example, when four drives have been connected, the syntax in the CONFIG.SYS file would be:

```
DEVICE=C:\IBMIDECD.SYS /D:IBRC01 /P:1F .34  
/P:17 .35 /P:1E .32 /P:16 .1
```

Do not truncate the actual device driver entry. Place the complete DEVICE= on one line in the CONFIG.SYS file.

**/A:n** specifies the audio play mode. For a stereo CD, /A:0 or /A:1 is acceptable. For a monaural CD (left or right channel only),

**/A:1** will play the monaural audio signal from both the right and left channels. The default is n=0.

**/U:n** Initialize with the tray locked or unlocked. /U:0 is unlock.

**/U:1** is lock. The default is n=0. This command might be used if you wish to secure your CD in the drive.

**/L:xx** specifies the message language where xx designates the language.

US: English (default, does not need to be specified)  
GR: German  
FR: French  
SP: Spanish  
IT: Italian  
JP: Japanese

**/T:n** initializes with time delays built into the IDE read loop. Use this parameter only in computers that do not support the IOCHRDY signal on the IDE bus, and that read from the IDE port faster than the CD-ROM can provide data. This is a very uncommon situation and normally this parameter is not required in most computers.

**n** is a relative timing parameter that depends on processor speed. The larger the value of n, the slower the drive will transfer data. Valid values for n are 0 through 99. The default for n is 0, and the /T parameter is not required.

**/I:n** enables interrupt sharing. If n=1, interrupt sharing is enabled. If n=0, interrupt sharing is disabled. The default value is 0. Enable this parameter when the IDE interrupt must be shared with another device. For example, a PS/2 9577 computer with IDE could share interrupt 14 with the IBM SCSI Adapter /A.

#### **Microsoft CD-ROM Extensions:**

Microsoft CD-ROM Extensions (MSCDEX.EXE) is an executable program that works in conjunction with the device driver (IBMIDECD.SYS) to allow your computer to access CDs as if they were DOS-formatted disks. MSCDEX is specifically designed to work with DOS and Windows.

CDSETUP automatically adds an MSCDEX statement to your AUTOEXEC.BAT file. You can modify the default MSCDEX parameters to customize your installation. This section explains the function of each parameter. A text editor can be used to modify the MSCDEX statement in your AUTOEXEC.BAT file.

The following is the syntax of the MSCDEX.EXE entry in AUTOEXEC.BAT where *drive: /path* MSCDEX.EXE specifies the location (drive and directory) of the MSCDEX.EXE file.

```
(drive) (path)MSCDEX.EXE
/D:device name[/M] [/E]
[/V] [/L:drive letter[/K]]/S:
```

Do not truncate the actual device driver entry. Place the complete entry on one line in the AUTOEXEC.BAT file. Use the following options to configure the device driver.

**/D:device name** specifies the name of the CD-ROM drive (eight characters maximum). This must be identical to the device name specified in the device driver in the CONFIG.SYS file. For example:

```
C:\MSCDEX.EXE /D:IBMCD1
```

You might support multiple CD-ROM drives (of different types) by installing each of their drivers (naming them different names) and placing a /D:device name in the MSCDEX line for each drive. For example, if you wanted to support an IBM IDE CD-ROM drive and an IBM SCSI CD-ROM drive, your CONFIG.SYS file could have these statements:

```
DEVICE=C:\IBMIDECD.SYS /D:IDE_CD
DEVICE=C:\IBMSCDROM.SYS /D:SCSI_CD
```

and your AUTOEXEC.BAT file would have this statement:

```
C:\MSCDEX /D:IDE_CD /D:SCSI_CD
```

**/M:nn** specifies the number of sector buffers for temporary storage of the most recent CD data. For example, to specify 12 sector buffers you would use:

```
C:\MSCDEX.EXE /D:IBMCD1 /M:12
```

CDSETUP will set this value to 10. The default value for MSCDEX with no /M parameter is 4. The greater this value, the better the CD-ROM drive will perform. However, each buffer uses about 2 KB of memory, and specifying too many buffers might slow down your computer or interfere with other programs that have large memory-usage requirements. Using expanded memory (see the /E option in this section) or loading MSCDEX.EXE into high memory (refer to your DOS user manual or memory manager user manual) might allow you to specify a larger number of buffers to enhance CD-ROM performance without adversely affecting programs that have large memory-usage requirements.

**/E** instructs the computer to use expanded memory, if available. For example:

```
C:\MSCDEX.EXE /D:IBMCD1 /E
```

Note that you must first load an expanded memory device driver before using this option. If no expanded-memory device driver is loaded, the following error message appears: Expanded Memory not present or not usable.

**/V** instructs the computer to display a summary of RAM allocation and expanded memory usage at startup time.

**/L:drive letter** specifies the drive letter to be assigned to the first CD-ROM drive. Do not assign a letter already used by an existing drive or your computer will be unable to access the CD-ROM drive. For example, you might use:



```
C:\MSCDEX.EXE /D:1EBCD1 /L:F
```

Normally, the CD-ROM drive is assigned to the next available drive letter after the devices such as diskette drives and hard disk drives. Therefore, you use this option only if you wish to assign a drive letter beyond the last letter previously allocated by DOS.

**/K** instructs MSCDEX.EXE to use Kanji (Japanese) file structures, if present, rather than the default alphanumeric file structures.

**/S** instructs MSCDEX.EXE to allow sharing of CD-ROM drives on networked computers.

#### **Conserving DOS Conventional Memory:**

If the CD-ROM support software is loaded in DOS conventional memory (below 640 KB RAM), there might be insufficient memory to run some DOS applications. The CDSETUP program attempts to load the IDE CD-ROM device driver and MSCDEX into upper memory, when possible, to avoid this problem.

See the following topics in your DOS User's Guide for more information on techniques to conserve conventional memory:

DOS=UMB, DOS=HIGH,UMB (CONFIG.SYS entry.) This loads DOS high and enables the use of upper memory. This

is essential to effectively load MSCDEX and the IDE CD-ROM device driver in upper memory.

HIMEM.SYS (CONFIG.SYS entry.) This is a device driver that manages extended memory (RAM memory above 1 MB). Windows automatically loads this device driver.

EMM386.EXE (CONFIG.SYS entry.) This is a device driver that allows the extended memory made available by HIMEM.SYS to be used as expanded memory. The MSCDEX /E parameter might be used in conjunction with this device driver to move the cache allocated by MSCDEX into this memory, thus freeing some conventional memory.

**MEM /C /P** (use from DOS prompt.) This is a useful DOS utility that will display the current memory allocation in your computer to help you understand where device drivers and programs are located. To display the MEM parameters available, at the DOS prompt type mem/?

#### **Enhancing Performance:**

Following are two ways to enhance CD-ROM performance on your computer:

1. Allocate more MSCDEX cache (see /M parameter for MSCDEX).
2. Allow SMARTDRV to cache CD-ROM accesses.

The CDSETUP utility disables the cache CD-ROM data function. Multi-session CDs are not compatible with the SMARTDRV

caching method. If you do not plan to use PhotoCD or multiple-session CDs, you might re-enable caching by removing

the /U parameter from the SMARTDRV line in your AUTOEXEC.BAT or CONFIG.SYS file. This might improve the performance of some CD-ROM applications. You must have SMARTDRV 5.0 or higher to cache CD-ROM data.

#### **Networking:**

If you are using the IDE CD-ROM drive in a DOS Network server you must make the following changes:

1. Add the /S parameter to the MSCDEX line in the AUTOEXEC.BAT file.
2. Check that the MSCDEX line is located after the line that loads the network services (NET START for IBM PC LAN program).

3. Do one of the following, depending on your operating system:

If you are using DOS 3.3, be sure you have PC Local Area Network (LAN) Program Corrective Service Diskette level IP00755 or later installed. If you are using DOS 4.0, be sure you have DOS Corrective Service Diskette level UR 29015 or higher installed. (The computer cannot be configured as an Extended Services Domain Controller for the IBM PC LAN Program.)

Contact your IBM reseller for more information about the PC LAN Program Corrective Service Diskette or the DOS Corrective Service Diskette.

#### **OS/2 Software:**

User requirements vary, and you might need to customize the setup which DDINSTALL has installed on your computer. This section provides information and describes parameters that you might need to change or add for your installation.

#### **Device Manager Driver:**

OS/2 uses the OS2CDROM.DMD device driver

```
DEVICE=OS2CDROM.DMD [Options]
```

to control all CD-ROM devices. The following options are available:

**/V** Instructs the computer to display the installation details.

**/Q** Suppresses messages during initialization.

#### **Device Driver Filter:**

OS/2 uses the device driver filter IBMIDECD.FLT for ATAPI (IDE) CD-ROM drives.

```
BASEDEV=IBMIDECD.FLT [Options]
```

The following option is available: **/V** Instructs the computer to display installation details.

#### **Installable File System Driver:**

The file system driver for OS/2 is CDFS.IFS. The following options are available:

**/C:n** indicates how many 64 KB RAM segments will be used for the sector cache. The default is two 64 KB RAM segments.

**/M:n** Indicates the maximum number of file sectors to be read at a time. The default is eight sectors.

**/K** Uses Kanji supplementary volume descriptor.

**/Q** Suppresses messages during initialization.

#### **IDE Adapter Device Driver:**

The following IDE device drivers are available:

```
BASEDEV=IBM1S5 5.BDD (for ISA computers)
```

This device driver controls IDE hard disk drives and IDE CD-ROM drives. From the OS/2 command prompt, type help IBM1S506 to see the optional parameters that are available for ISA computers.

Special parameters are required if your computer has an IDE controller that does not use a standard interrupt. Check the **/A** and **/IRQ** parameters in the OS/2 help utility. If you have a Microchannel computer, an IDE

device driver is available for Microchannel architecture on the IBM website. Use the website search utility, and look for IBM2IDE.ADD.

### **Windows 95 Software:**

Windows 95 has two device driver configuration parameters: Auto Insert Notify and DMA.

#### **Auto Insert Notify:**

The Auto Insert Notify parameter enables the system to start audio CD software as soon as a CD is inserted into the CD-ROM drive.

#### **DMA:**

The DMA parameter improves system performance by having the system DMA controller take responsibility for moving data from the CD to memory, freeing the system CPU to perform more important tasks. For example, activating DMA will make movies and games run more smoothly because the CPU will have more time to concentrate on video.

To change these parameter settings from the Windows 95 desktop:

1. Click on Start from the main screen.
2. Select Settings; click on Control Panel.
3. From the Control Panel, double-click on System.
4. Select Device Manager; double-click on CD-ROM and then click on Properties.
5. Select Settings.
6. Click on Auto Insert Notification or DMA.
7. Click on OK.

### **Problem Solving:**

Computer problems can be caused by hardware, software, or user error. Using the information in this section, you might be able to solve problems yourself or gather helpful information you can pass on to a service technician. You might also need to refer to your computer, operating-system, or sound-adaptor publications.

Review the following list for any problem descriptions that might fit your situation. Your computer or CD-ROM drive does not operate correctly or the busy indicator light does not come on.

Take the following actions:

1. Check that the CD is loaded with the label side up.
2. Check that all devices are properly connected to the computer and the power outlet.
3. Turn off the computer, unplug the cables from the power outlets for your computer and all attached devices, and remove the computer cover.
4. Check that all power and IDE cables are securely attached.

Disconnect the IDE cable and check for bent or misaligned pins. If you do not find any problems, reconnect the interface cable. Replace the computer cover, and reattach all cables and power cords. Turn on the computer, restart the system, and attempt to open the CD tray by pressing the Eject/Load button. If the tray fails to open and the busy indicator light does not display, turn off the computer and try using another 4-pin dc power cable.

5. Check that the color-coded edge on the IDE cable aligns with pin 1 on the IDE port and is closest to the power cable on the CD-ROM drive. See *Attaching the Cables to the Drive*.
6. Check that the IDE cable is connected to the proper IDE port connection. See *Installation Requirements* for more information.
7. Check the CD-ROM drive and any other device on the IDE cable for the proper settings. See *Selecting an IDE Port* for more information.
8. If the middle connector on the IDE cable is attached to the IDE port on the system board, remove the connector and reattach the cable. If there is only one device on the IDE port, attach the connector at one end of the cable to the IDE port and the connector at the other end to the device, leaving the middle connector (if there is one) open.

If there are two devices on the IDE port, attach the connector at one end of the cable to the IDE port. If there is a hard disk drive, attach it to the connector at the other end of the cable and attach the CD-ROM drive to the middle connector.

**You cannot access the CD-ROM (DOS and Windows 3.X) or the CD-ROM icon (Windows) does not display.**

Your CD-ROM device driver might not be loaded or cannot be found. Before checking the CONFIG.SYS and AUTOEXEC.BAT files, make a backup copy of these files in a convenient directory.

1. At the DOS prompt:
  - a. Type `copy CONFIG.SYS CONFIG.IBM` and press `Enter`.
  - b. Type `copy AUTOEXEC.BAT AUTOEXEC.IBM` and press `Enter`.
2. Use a text editor such as E or Edit. At the DOS prompt, type E (or your editor name) CONFIG.SYS and press `Enter`.
3. Insert the following line at the top of the CONFIG.SYS file to allow for more than five drive letters, if needed.

```
lastdrive=z
```

4. Check for the line that refers to the device driver.

```
DEVICEHIGH=C:\FBIIDECDL.SYS /D:1BKC01
```

If this line is not present, add it.

5. Save the CONFIG.SYS file and exit.
6. Type E (or your editor name) AUTOEXEC.BAT, press `Enter`.

7. Check for the line that refers to the device driver.

```
IF C:\MSCDEX /D:1BKC01 /M:1
```

If this line is not present, add it.

8. If the Windows screen automatically displays when you start your computer, check that the line

```
IF C:\MSCDEX /D:1BKC01 /M:1
```

comes before the line that starts Windows (WIN). If not, move the MSCDEX statement above this line in the file.

9. Save the AUTOEXEC.BAT file and exit.

10. Make sure that the device drivers are on the hard disk and in the correct directory.

```
C:\IBM\DECD.SYS  
C:\MSCDDEX
```

If the drivers are not present, reinstall them. See the READ.ME file on the IBM 32X-12X Internal IDE CD-ROM Drive Option Diskette for more information.

**You cannot access the CD-ROM or the CD-ROM icon does not display (Windows 95).**

When the CD-ROM drive is properly installed, a CD-ROM icon will be found in the My Computer window. Double-click on My Computer. If a CD-ROM icon is not present in the window that displays, make sure that the drive has been properly installed. Make sure that the configuration jumper is set properly. See Setting the Configuration Jumper. Restart your system.

If a drive icon is still not found, continue with the following steps.

1. Click on the Start button, and point to Settings. The Settings window will be displayed.
2. Click on Control Panel.
3. Click on System.
4. Click on the Device Manager tab.
5. Double-click on View Devices by Type.
  - a. Click on Hard Disk Controllers to select it from the Device Manager list. Make sure that there are no conflicts with the controller. The device status should indicate that the controller is working properly.
  - b. Select CD-ROM from the Device Manager list. A CD-ROM device should be present, and no conflicts should exist. The device status should indicate that the device is working properly.
6. Click on OK.
7. Shut down and restart the computer.

If the device icon is still not present, check cable connections, device jumper settings, and resolve any conflicts that may exist.

**You cannot access the CD-ROM or the CD-ROM icon does not display (OS/2).**

Your CD-ROM device driver might not be loaded or cannot be found. Before checking the CONFIG.SYS file, make a backup copy of this file in a convenient directory.

1. At the DOS prompt:
  - a. Type copy CONFIG.SYS CONFIG.IBM, and press Enter.
  - b. Type copy AUTOEXEC.BAT AUTOEXEC.IBM, and press Enter.
2. Use a text editor such as EPM or E from the OS/2 prompt. The following instructions use the EPM editor. Type EPM CONFIG.SYS, and press Enter.
3. Check for the lines that refer to the device driver.

```
DEVICE=C:\OS2\BOOT\OS2CDROM.DMD /Q  
EPM=C:\OS2\BOOT\CDPS.EPS /Q  
DEVICE=C:\OS2\MKKSA\CDROM.SYS  
BASEDEV=IBMTRCD.PLT
```

If these lines are not present, add them.

4. Save any changes and exit the CONFIG.SYS file.
5. Check that the device drivers are on the hard disk drive and in the correct directory.

```
C:\OS2\BOOT\OS2CDROM.DMF  
C:\OS2\BOOT\CDRES.JES
```

If the drivers are not present, reinstall them. See the READ.ME file on the IBM 32X-12X Internal IDE CD-ROM Drive Option Diskette for more information.

**The CD-ROM is not recognized by the operating system or the drive performs erratically.**

Some computers, such as IBM PS/ValuePoint models 6472, 6482, 6484, 6492, and 6494, have a compatible and a high performance mode for mass storage devices. Normally, the CD-ROM drive functions better under high performance mode.

However, if your drive is not functioning properly in that mode, you might need to use compatible mode. Check the configuration-setup information for your computer.

1. Access your configuration utility program.
2. Select Devices.
3. Scroll down to the Mass Storage Devices section.
4. **Mass Storage Devices** contains the entries **Primary IDE Mode** and **Secondary IDE Mode**. These entries are used to set the performance mode of each IDE port. Set the mode to **Compatible** for the port on which you installed your CD-ROM drive.

Other IBM and non-IBM computers might have similar settings. Check to see if your BIOS or configuration-setup utility provides for *compatible* and *high performance* modes for IDE performance. For these computers, use the *compatible* mode for slower IDE devices, such as this CD-ROM drive. Refer to the documentation that comes with your computer for additional details on selecting IDE performance modes. Many older computers will not have a selection of IDE performance modes.

**The computer does not recognize the CD-ROM drive after the device drivers are loaded.**

Check for incompatibilities among the CD-ROM device driver and other device drivers or other hardware in your computer. Create a System Diskette with minimum CONFIG.SYS and AUTOEXEC.BAT system files.

1. Before creating special CONFIG.SYS and AUTOEXEC.BAT files, make a backup copy of these files in a convenient directory, (if you have not already done so).

At the DOS prompt:

Type copy CONFIG.SYS CONFIG.IBM and press Enter.  
Type copy AUTOEXEC.BAT AUTOEXEC.IBM and press Enter.

2. Create a System Diskette and copy the device drivers onto it. For DOS and Microsoft Windows 3.X:
  - a. Insert a blank diskette into drive A.
  - b. At the DOS prompt, type format a: /s and press Enter. The /s parameter creates the System Diskette. Follow the instructions on the screen.
  - c. When the format process completes, copy the C:\IBMIDECD.SYS and C:\MSCDEX files from the hard disk to the System Diskette.

d. Using a text editor, create a minimum CONFIG.SYS system file on the System Diskette to support only a CD-ROM drive. The following procedure uses the E text editor to create the CONFIG.SYS file from the A prompt.

- Type `e config.sys` and press Enter.
- In the editor, type `lastdrive=z` and press Enter.
- Type `device=a:\ibmidecd.sys /d:ibmcd100` and press Enter.
- Save the CONFIG.SYS file and exit the editor.

e. Create a System Diskette to support only a CD-ROM drive.

The following procedure uses the E text editor to create the AUTOEXEC.BAT file from the A prompt.

- Type `e autoexec.bat` and press Enter.
- Type `a:\mscdex /d:ibmcd100 /m:10` and press Enter.
- Save the AUTOEXEC.BAT file and exit the editor.

3. Turn off the computer and check that the System Diskette is in the diskette drive.
4. Restart the computer (the computer will start up from the System Diskette).
5. Observe the startup messages and check that the device driver, IBMIDECD.SYS, loads. When MSCDEX loads, observe the drive letter that the computer assigns to the CD-ROM drive.
6. Load a data CD into the CD tray; then wait until the busy indicator is not lit.
7. Attempt to read the CD by typing `dir x:` where x is the CD-ROM drive assigned after the MSCDEX message.

If the computer is able to read the CD, a conflict probably exists among the device drivers loaded in either the CONFIG.SYS or AUTOEXEC.BAT files. You need to resolve this device conflict. You might have to set some configuration parameters for your installation; refer to Customizing Device Driver Configuration Settings for more information.

If you are unable to access the CD, you might have a hardware problem. If you are unable to read the CD or a drive letter is not assigned by MSCDEX, go to the next step.

8. Turn off the computer, unplug the cables from the power outlets for your computer and all attached devices, and remove the computer cover.
9. Disconnect the IDE and power cable for all IDE devices except the CD-ROM drive.
10. Configure the CD-ROM drive as a master and connect it to the last IDE connector on the primary IDE port.
11. Reinstall the computer cover. Reconnect the keyboard; plug the power cords into electrical outlets.
12. Place the System Diskette in the diskette drive and a data CD in the CD-ROM drive.
13. Restart the computer.
14. Attempt to read the CD by typing `dir C:.` (The CD-ROM drive is drive C because it is the only device connected to the IDE port.)

If the computer is able to read the CD, a conflict probably exists with one of the devices that was installed on your computer. You need to resolve this device driver conflict. Check the configuration jumper settings for the other devices or refer to your device documentation. To contact your hard disk drive manufacturer, see Hard Disk Drive Manufacturers for more information.

If you are unable to access the CD, you might have a hardware problem. If the CD-ROM drive still does not read the data CD, the CD-ROM drive might be defective. Go to Help and Service Information.

#### **The CD cannot be read.**

Consider the following actions:

- The CD might be dirty; clean it as described in Caring for a CD.
- The CD might be defective; try another CD.
- The CD is not ISO-9660 or High Sierra Group (HSG) compatible.
- Check with your place of purchase.

#### **There is no sound from the CD.**

Consider the following actions:

- Check that you are using an audio CD and not a data CD.
- Adjust the volume control on the drive. See Front View of the Drive if headphones are connected to the front of the drive.
- Adjust the sound-adaptor volume control. See the documentation that comes with your sound adapter and audio-CD player program.
- Turn off the computer, unplug the cables from the power outlets for your computer and all attached devices, and remove the computer cover. Check that the audio-signal cable connects the CD-ROM drive with the sound adapter.

#### **You receive a common error message.**

These are actions for some common error messages:

- |         |  |
|---------|--|
| CDR-103 | The CD in the CD-ROM drive is not a High Sierra or ISO 9660 format. The CD-ROM drive does not support this format.   |
| CDR-101 | The "not ready reading the drive" situation occurs if you try to access the CD-ROM drive before the drive is ready. The busy indicator comes on when you attempt to access the drive after loading a CD into the CD tray. Wait until the busy indicator is no longer lit before attempting to access the drive. The connectors on the audio cables provided do not fit the connector on your sound adapter. Some sound adapters might require a special cable. See the documentation that comes with your sound adapter. |

You might have to separately purchase an audio cable for the CD-ROM drive. The audio-out connector on the CD-ROM drive requires a MPC-2 compliant Molex 70066-G connector. (Refer to Back View of the Drive to locate the audio connector.) If you are using an IBM computer or IBM sound adapter, refer to Help and Service Information for assistance.

#### **Diagnostics:**

To help you solve CD-ROM drive problems, the IBM 32X-12X Internal IDE CD-ROM Drive Option Diskette contains a general purpose diagnostic program. You must successfully load the CD-ROM drive device drivers before starting the diagnostics. The program can be run only from a real DOS prompt. You cannot run the diagnostic program in a DOS session under OS/2, or in DOS under Windows or Windows 95.



To start the diagnostic program, go to the DOS prompt and change to drive A. Then insert the IBM 32X-14X Internal IDE CD-ROM Drive Option Diskette, type CDDIAG and press Enter.

**Additional Help:**

The READ.ME file on the IBM 32X-14X Internal IDE CD-ROM Drive Option Diskette includes troubleshooting hints. If you follow these instructions and still have a problem, go to Help and Service Information.

**Help and Service Information:**

If you have questions about your new Options by IBM product, or require technical assistance, visit the IBM Personal Computing Web site at <http://www.pc.ibm.com> for information about IBM, Options by IBM, or IBM Service and Support. Additionally, you can receive information from the IBM Automated Fax system at 1-800-426-3395 (in Canada, call 1-800-465-3299), or from the Personal Systems Group Bulletin Board System (PSG BBS) at

1-919-517-0001. You can also get help and information through the IBM PC HelpCenter, 24 hours a day, seven days a week. Response time may vary depending on the number and nature of the calls received.

Marketing, installation, and configuration support through the HelpCenter will be withdrawn or made available for a fee, at IBM's discretion, 90 days after the option has been withdrawn from marketing. Additional support offerings, including step-by-step installation assistance, are available for a nominal fee.

During the warranty period, assistance for replacement or exchange of defective components is available. In addition, if your IBM option is installed in an IBM computer, you might be entitled to service at your location. Your technical support representative can help you determine the best alternative.

Before calling IBM technical support, try to solve the problem by using the information in "Problem Solving." If you are unable to solve the problem yourself, this section contains information on how to reach your IBM technical support representative.

Online technical support is available during the life of your product. Online assistance can be obtained through the IBM Personal Computing Automated Fax System, the Personal Computing Web page, and the PSG

Electronic Bulletin Board System.

**Preparing for the Call:**

To assist the technical support representative, have available as much of the following information as possible:

- Option name, description and serial number (if any.)
- Option and or Field Replaceable Unit (FRU) part numbers.
- Proof of purchase.
- Computer manufacturer, model, serial number (if IBM) and manual.
- Exact wording of the error message (if any.)
- Description of the problem.
- Hardware and software configuration information for your system.
- If possible, be at your computer. Your technical support representative might want to walk you through the problem during the call.

**Placing the Call to IBM:**

If you call 90 days or more after the date of withdrawal or after your warranty has expired, you might be charged a fee.

For the support telephone number and support hours by country, refer to the following table or to the enclosed technical support insert.

If the number is not provided, contact your IBM reseller or IBM marketing representative.

**Support 24 hours a day, 7 days a week:**

Canada	1-800-565-3344
Puerto Rico	1-800-772-2227
United States	1-800-772-2227

**Computer and BIOS Manufacturers:**

Use the following table for computer manufacturer information. For manufacturers not in the table, contact your IBM reseller.

Use the following table for BIOS manufacturer information. For manufacturers not in the table, contact your IBM reseller:

IBM	1-800-772-2227
AST	1-800-727-1278
Compaq	1-800-652-6672
Dell	1-800-624-9896
Digital	1-800-354-9000
Gateway 2000	1-800-846-2301
HP	1-208-323-4663
NEC	1-800-388-8888
Packard Bell	1-800-733-4411
AMI	1-770-246-8645
Award	1-415-968-4433
MR BIOS	1-508-686-6468
Phoenix	1-617-551-4000
Micro Firmware (Phoenix systems only)	1-405-321-8333

**Hard Disk Drive Manufacturers:**

Use the following table for disk manufacturer information, as needed. For manufacturers not in the table, contact your IBM reseller.

Manufacturer	Telephone	BBS	Fax	Internet Address
IBM Corporation U.S.A.	1-800-772-2227	1-919-517-0001	1-800-426-3395	<a href="http://www.pc.ibm.com">http://www.pc.ibm.com</a> <a href="http://www.ibm.com">http://www.ibm.com</a>
Maxtor Corporation U.S.A.	1-800- 2MAXTOR	1-303-678-2222 (2400 baud)	1-800- 2MAXTOR 1-303-678-2260	<a href="http://www.maxtor.com">http://www.maxtor.com</a>
Quantum Peripherals U.S.A.	1-800-826-8022	1-408-894-3214	1-800-434-7532	<a href="http://www.quantum.com">http://www.quantum.com</a>
Seagate Technology, Inc.	1-800- SEAGATE	1-408-434-1080	1-800- SEAGATE 1-408-456-4496	<a href="http://www.seagate.com">http://www.seagate.com</a>
Western Digital Corporation U.S.A.	1-714-932-4900 1-507-286-7900	1-714-753-1234	714-932-4900 1-507-286-7900	<a href="http://www.wdc.com">http://www.wdc.com</a>

**Product Warranty:**

The following warranty information applies to products purchased in the United States, Canada, and Puerto Rico. For warranty terms and conditions for products purchased in other countries, see the enclosed Warranty insert, or contact your IBM reseller or IBM marketing representative.

International Business Machines Corporation  
Armonk, New York, 10504

**Statement of Limited Warranty:**

The warranties provided by IBM in this Statement of Limited Warranty apply only to Machines you originally purchase for your use, and not for resale, from IBM or your reseller. The term Machine means an IBM machine, its features, conversions, upgrades, elements, or accessories, or any combination of them.

Unless IBM specifies otherwise, the following warranties apply only in the country where you acquire the Machine. If you have any questions, contact IBM or your reseller.

**Machine:** IBM 32X - 14X Internal IDE CD-ROM Drive (p/n 04K0058.)

**Warranty Period\*:** One Year

\* Contact your place of purchase for warranty service information.

**Production Status:**

Each Machine is manufactured from new parts, or new and used parts. In some cases, the Machine may not be new and may have been previously installed. Regardless of the Machine's production status, IBM's warranty terms apply.

**The IBM Warranty for Machines:**

IBM warrants that each Machine 1) is free from defects in materials and workmanship and 2) conforms to IBM's Official Published Specifications. The warranty period for a Machine is a specified, fixed period commencing on its Date of Installation. The date on your receipt is the Date of Installation, unless IBM or your reseller informs you otherwise.

During the warranty period IBM or your reseller, if authorized by IBM, will provide warranty service under the type of service designated for the Machine and will manage and install engineering changes that apply to the Machine.

For IBM or your reseller to provide warranty service for a feature, conversion, or upgrade, IBM or your reseller may require that the Machine on which it is installed be 1) for certain Machines, the designated, serial-numbered Machine and 2) at an engineering-change level compatible with the feature, conversion, or upgrade.

Many of these transactions involve the removal of parts and their return to IBM. You represent that all removed parts are genuine and unaltered. A part that replaces a removed part will assume the warranty service status of the replaced part.

If a Machine does not function as warranted during the warranty period, IBM or your reseller will repair it or replace it with one that is at least functionally equivalent, without charge. The replacement may not be new, but will be in good working order. If IBM or your reseller is unable to repair or replace the Machine, you may return it to your place of purchase and your money will be refunded.

If you transfer a Machine to another user, warranty service is available to that user for the remainder of the warranty period. You should give your proof of purchase and this Statement to that user. However, for Machines which have a life-time warranty, this warranty is not transferable.

**Warranty Service:**

To obtain warranty service for the Machine, you should contact your reseller or call IBM.  
In the United States, call IBM at 1-800-772-2227  
In Canada, call IBM at 1-800-565-3344.

You may be required to present proof of purchase.

IBM or your reseller will provide certain types of repair and exchange service, either at your location or at IBM's or your reseller's service center, to restore a Machine to good working order. When a type of service involves the exchange of a Machine or part, the item IBM or your reseller replaces becomes its property and the replacement becomes yours.

You represent that all removed items are genuine and unaltered. The replacement may not be new, but will be in good working order and at least functionally equivalent to the item replaced. The replacement assumes the warranty service status of the replaced item. Before IBM or your reseller exchanges a Machine or part, you agree to remove all features, parts, options, alterations, and attachments not under warranty service. You also agree to ensure that the Machine is free of any legal obligations or restrictions that prevent its exchange.

**You agree to:**

1. Obtain authorization from the owner to have IBM or your reseller service a Machine that you do not own; and
2. where applicable, before service is provided --
  - a. follow the problem determination, problem analysis, and service request procedures that IBM or your reseller provide,
  - b. secure all programs, data, and funds contained in a Machine, and
  - c. inform IBM or your reseller of changes in a Machine's location.

IBM is responsible for loss of, or damage to, your Machine while it is 1) in IBM's possession or 2) in transit in those cases where IBM is responsible for the transportation charges.

**Extent of Warranty:**

IBM does not warrant uninterrupted or error-free operation of a Machine. The warranties may be voided by misuse, accident, modification, unsuitable physical or operating environment, improper maintenance by you, removal or alteration of Machine or parts identification labels, or failure caused by a product for which IBM is not responsible.

THESE WARRANTIES REPLACE ALL OTHER WARRANTIES OR CONDITIONS, EXPRESS OR IMPLIED, INCLUDING, BUT NOT LIMITED TO, THE IMPLIED WARRANTIES OR CONDITIONS OF MERCHANTABILITY AND FITNESS FOR A PARTICULAR PURPOSE. THESE WARRANTIES GIVE YOU SPECIFIC LEGAL RIGHTS AND YOU MAY ALSO HAVE OTHER RIGHTS WHICH VARY FROM JURISDICTION TO JURISDICTION. SOME JURISDICTIONS DO NOT ALLOW THE EXCLUSION OR LIMITATION OF EXPRESS OR IMPLIED WARRANTIES, SO THE ABOVE EXCLUSION OR LIMITATION MAY NOT APPLY TO YOU. IN THAT EVENT SUCH WARRANTIES ARE LIMITED IN DURATION TO THE WARRANTY PERIOD. NO WARRANTIES APPLY AFTER THAT PERIOD.

**Limitation of Liability:**

Circumstances may arise where, because of a default on IBM's part or other liability you are entitled to recover damages from IBM. In each such instance, regardless of the basis on which you are entitled to claim damages from IBM (including fundamental breach, negligence, misrepresentation, or other contract or tort claim), IBM is liable only for:

1. Damages for bodily injury (including death) and damage to real property and tangible personal property; and
2. the amount of any other actual direct damages or loss, up to the greater of U.S. \$100,000 or the charges (if recurring, 12 months' charges apply) for the Machine that is the subject of the claim.

UNDER NO CIRCUMSTANCES IS IBM LIABLE FOR ANY OF THE FOLLOWING: 1) THIRD-PARTY CLAIMS AGAINST YOU FOR LOSSES OR DAMAGES (OTHER THAN THOSE UNDER THE FIRST ITEM LISTED ABOVE); 2) LOSS OF, OR DAMAGE TO, YOUR RECORDS OR DATA; OR 3) SPECIAL, INCIDENTAL, OR INDIRECT DAMAGES OR FOR ANY ECONOMIC CONSEQUENTIAL DAMAGES (INCLUDING LOST PROFITS OR SAVINGS), EVEN IF IBM OR YOUR RESELLER IS INFORMED OF THEIR POSSIBILITY. SOME JURISDICTIONS DO NOT ALLOW THE EXCLUSION OR LIMITATION OF INCIDENTAL OR CONSEQUENTIAL DAMAGES, SO THE ABOVE EXCLUSION OR LIMITATION MAY NOT APPLY TO YOU.

**Notices:**

**Electronic Emission Notices:**

**Federal Communications Commission (FCC) Statement.**

Note: This equipment has been tested and found to comply with the limits for a Class B digital device, pursuant to Part 15 of the FCC Rules. These limits are designed to provide reasonable protection against harmful interference in a residential installation. This equipment generates, uses, and can radiate radio frequency energy and, if not installed and used in accordance with the instructions, may cause harmful interference to radio communications. However, there is no guarantee that interference will not occur in a particular installation. If this equipment does cause harmful interference to radio or television reception, which can be determined by turning the equipment off and on, the user is encouraged to try to correct the interference by one or more of the following measures:

- Reorient or relocate the receiving antenna.
- Increase the separation between the equipment and receiver.
- Connect the equipment into an outlet on a circuit different from that to which the receiver is connected.
- Consult an IBM authorized dealer or service representative for help.

IBM is not responsible for any radio or television interference caused by using other than recommended cables and connectors or by unauthorized changes or modifications to this equipment. Unauthorized changes or modifications could void the user's authority to operate the equipment.

This device complies with Part 15 of the FCC Rules. Operation is subject to the following two conditions:

1. This device may not cause harmful interference; and
2. this device must accept any interference received, including interference that may cause undesired operation.

**Industry Canada Compliance Statement:**

This digital apparatus does not exceed the Class B limits for radio noise emissions from digital apparatus as set out in the interference-causing equipment standard entitled: Digital Apparatus, ICES-003 of Industry Canada.

**Avis de conformité aux normes d'Industrie Canada:**

Cet appareil numérique respecte les limites de bruits radioélectriques applicables aux appareils numériques de Classe B prescrites dans la norme sur le matériel brouilleur: Appareils numériques, NMB-003 édictée par Industrie Canada.

**Telecommunication Notices:**

Federal Communications Commission (FCC) and Telephone Company Requirements.

1. This adapter complies with Part 68 of the FCC rules. A label is affixed to the adapter that contains, among other things, the FCC registration number, USOC, and Ringer Equivalency Number (REN) for this equipment. If these numbers are requested, provide this information to your telephone company.
2. The REN is useful to determine the quantity of devices you may connect to your telephone line and still have those devices ring when your number is called. In most, but not all areas, the sum of the RENs of all devices should not exceed five (5.0). To be certain of the number of devices you may connect to your line, as determined by the REN, you should call your local telephone company to determine the maximum REN for your calling area.
3. If the adapter causes harm to the telephone network, the telephone company may discontinue your service temporarily. If possible, they will notify you in advance; if advance notice is not practical, you will be notified as soon as possible. You will be advised of your right to file a complaint with the FCC.
4. Your telephone company may make changes in its facilities, equipment, operations, or procedures that could affect the proper operation of your equipment. If they do, you will be given advance notice to give you an opportunity to maintain uninterrupted service.
5. If you experience trouble with this product, contact your Authorized Reseller, or call IBM. In the United States, call IBM at 1-800-426-7299. In Canada, call IBM at 1-800-565-3344. You may be required to present proof of purchase. The telephone company may ask you to disconnect the adapter from the network until the problem has been corrected, or until you are sure the adapter is not malfunctioning.
6. No customer repairs are possible to the adapter. If you experience trouble with the adapter, contact your Authorized Reseller or see Appendix B of this manual for information.
7. This adapter may not be used on coin service provided by the telephone company. Connection to party lines is subject to state tariffs. Contact your state public utility commission or corporation commission for information.
8. When ordering network interface (NI) service from the local Exchange Carrier, specify service arrangement USOC RJ11C.

**Canadian Department of Communications Certification Label:**

NOTICE: The Canadian Department of Communications label identifies certified equipment. This certification means that the equipment meets certain telecommunications network protective, operational, and safety requirements. The Department does not guarantee the equipment will operate to the user's satisfaction.

Before installing this equipment, users should ensure that it is permissible to be connected to the facilities of the local telecommunications company. The equipment must also be installed using an acceptable method of connection. In some cases, the company's inside wiring associated with a single line individual service may be extended by means of a certified connector assembly (telephone extension cord). The customer should be aware that compliance with the above conditions may not prevent degradation of service in some situations.

Repairs to certified equipment should be made by an authorized Canadian maintenance facility designated by the supplier. Any repairs or alterations made by the user to this equipment, or equipment malfunctions, may give the telecommunications company cause to request the user to disconnect the equipment.

Users should ensure for their own protection that the electrical ground connections of the power utility, telephone lines, and internal metallic water pipe system, if present, are connected together. This precaution may be particularly important in rural areas.

CAUTION: Users should not attempt to make such connections themselves, but should contact the appropriate electric inspection authority, or electrician, as appropriate.

NOTICE: The LOAD NUMBER (LN) assigned to each terminal device denotes the percentage of the total load to be connected to a telephone loop which is used by the device, to prevent overloading. The termination on a loop may consist of any combination of devices subject only to the requirement that the sum of the LOAD NUMBERS of all the devices does not exceed 100.

**Étiquette d'homologation du ministère des Communications du Canada:**

AVIS : L'étiquette du ministère des Communications du Canada identifie le matériel homologué. Cette étiquette certifie que le matériel est conforme à certaines normes de protection, d'exploitation et de sécurité des réseaux de télécommunications. Le ministère n'assure toutefois pas que le matériel fonctionnera à la satisfaction de l'utilisateur. Avant d'installer ce matériel, l'utilisateur doit s'assurer qu'il est permis de le raccorder aux installations de l'entreprise locale de télécommunications. Le matériel doit également être installé en suivant une méthode acceptée de raccordement. L'abonné ne doit pas oublier qu'il est possible que la conformité aux conditions énoncées ci-dessus n'empêchent pas la dégradation du service dans certaines situations.

Les réparations de matériel homologué doivent être effectuées par un centr d'entretien canadien autorisé désigné par le fournisseur. La compagnie de télécommunications peut demander à l'utilisateur de débrancher un appareil à la suite de réparations ou de modifications effectuées par l'utilisateur ou à cause d'un mauvais fonctionnement.

Pour sa propre protection, l'utilisateur doit s'assurer que tous les fils de mise à la terre de la source d'énergie électrique, des lignes téléphoniques et des canalisations d'eau métalliques, s'il y en a, sont raccordés ensemble. Cette précaution est particulièrement importante dans les régions rurales.

Avertissement: l'utilisateur ne doit pas tenter de faire ces raccordements lui-même, il doit avoir recours à un service d'inspection des installations électriques ou à un électricien, selon le cas.

AVIS: L'INDICE DE CHARGE (IC) assigné à chaque dispositif terminal indique, pour éviter toute surcharge, le pourcentage de la charge totale qui peut être raccordé à un circuit téléphonique bouclé utilisé par ce dispositif. L'extrémité du circuit bouclé peut consister en n'importe quelle combinaison de dispositifs pourvu que la somme des INDICES DE CHARGE de l'ensemble des dispositifs ne dépasse pas 100.

**Notices:**

References in this publication to IBM products, programs, or services do not imply that IBM intends to make these available in all countries in which IBM operates. Any reference to an IBM product, program or service is not intended to state or imply that only IBM's product, program, or service may be used. Subject to IBM's valid intellectual property or other legally protectable rights, any functionally equivalent product, program, or service may be used instead of the IBM product, program, or service. The evaluation and verification of operation in conjunction with other products, programs, or services, except those expressly designated by IBM, are the responsibility of the user.

IBM may have patents or pending patent applications covering subject matter in this document. The furnishing of this document does not give you any license to these patents. You can send license inquiries, in writing:

IBM Director of Licensing  
IBM Corporation  
500 Columbus Avenue  
Thornwood, NY 10594  
U.S.A.