



#### Note

Before using this information and the product it supports, be sure to read the general information under "Safety information" on page xii and "Notices" on page 165.

#### Note for using your computer in Japan

- If you are using a modem in Japan, specify the country as "Japan" in the "Dialing Properties" window under the "Modem Properties" window. Using the modem functions with another setting is a violation of the Japanese Telecommunication Business Law.
- The AC Adapter complies with the Electrical Appliance and Material Control Law of Japan.

Rating:                      Input ac 100 V 50/60 Hz  
                                    Output dc 16 V

Certificate numbers (V):    91-53393  
   91-56010  
   91-56011  
   91-56012  
   91-56055  
   91-56271  
   91-56887

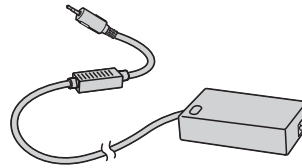

### First Edition (October 1999)

**The following paragraph does not apply to the United Kingdom or any country where such provisions are inconsistent with local law:**

INTERNATIONAL BUSINESS MACHINES CORPORATION PROVIDES THIS PUBLICATION "AS IS" WITHOUT ANY WARRANTY OF ANY KIND, EITHER EXPRESS OR IMPLIED, INCLUDING, BUT NOT LIMITED TO, THE LIMITED WARRANTIES OF MERCHANTABILITY OR FITNESS FOR A PARTICULAR PURPOSE. Some states do not allow disclaimers of express or implied warranties in certain transactions; therefore, this statement may not apply to you.

This publication could include technical inaccuracies or typographical errors. Changes are periodically made to the information herein; these changes will be incorporated in new editions of the publication. IBM may make improvements or changes in the products or the programs described in this publication at any time.

Requests for technical information about IBM products should be made to your IBM Authorized Dealer or your IBM Marketing Representative.

© Copyright International Business Machines Corporation 1999. All rights reserved. Note to U.S. Government Users – Documentation related to restricted rights – Use, duplication, or disclosure is subject to restrictions set forth in GSA ADP Schedule Contract with IBM Corp.

## ***Thank You for Selecting an IBM® ThinkPad® 600X Computer***

We have developed this ThinkPad computer to meet both your technical requirements and your high expectations. To help us continue to build products that address your needs for mobile computing, please take a moment to complete the ThinkPad Registration in the *Setup Guide*.



## Functional highlights

### *Compact design with core technology*

The slim, lightweight, and portable design of the ThinkPad 600X makes traveling with your computer much easier. Your computer is available wherever and whenever you need it.

### *High-speed processor*

The Intel® high-speed processor enables high-speed data processing and provides advanced performance.

### *Large-capacity hard disk drive*

The large-capacity hard disk drive can respond to a wide variety of your business demands.

### *Large color LCD*

The large TFT (thin-film transistor) display provides clear and brilliant text and graphics.

### *Lithium-ion battery pack*

The large-capacity lithium-ion battery pack extends the operating time of your computer, further enhancing its portability.

### *Audio with 3D stereo sound*

Your computer is equipped with internal audio record and playback capabilities, including 3D (three-dimensional) audio from just two speakers. When you enable the 3D stereo feature, sounds will appear to be generated all around you, even though only two speakers are used.

The audio feature supports the following:

- Wave audio recording and playback of up to 16 bits, stereo, and 44-KHz sampling.
- DOS games using the Sound Blaster interface.

To use the audio function ➡ *Online User's Guide*.

### *Mini-PCI modem*

The integrated modem enables you to send or receive data and faxes over a telephone line. Supporting V.90 protocol and data rates of up to 56 Kbps, the modem makes communication easy and efficient when you are away from your office.

To use the modem function → *Online User's Guide*.

### *TrackPoint® with enhanced controls*

Your computer has an enhanced TrackPoint function that enables you to make selections merely by pressing on the TrackPoint. The center button converts the TrackPoint into a scroll-controlling device or a magnifying glass on the screen.

To use the TrackPoint → "TrackPoint" on page 8.

### *PC Card support*

Your computer provides two PC Card slots that accept a 16-bit PC Card, CardBus Card, or Zoomed Video Card.

To install a PC Card → "Installing a PC Card" on page 75.



# Contents

---

Functional highlights	iv
About this book	x
Safety information	xii
Laser compliance statement	xv
Handling the ThinkPad computer	xvii
ThinkPad don'ts	xvii
ThinkPad do's	xix
Cleaning your computer	xix
Carrying your computer	xx
Extending the life of your computer's battery	xx
<b>Chapter 1. Getting familiar with your computer</b>	<b>1</b>
Identifying the hardware features	2
System-status indicators	6
Functions of your computer	8
Keyboard functions	8
Numeric keypad	14
UltraslimBay	15
ThinkPad Utility programs	16
Online User's Guide	29
Backing up your system	30
Recovering lost or damaged software	30
ConfigSafe	34
ThinkPad Web site	35
Replacing the battery pack	36
Getting service	38
Help at the ThinkPad Web site	38
Help by telephone	39
Recording sheets	40
<b>Chapter 2. Extending the features of your computer</b>	<b>43</b>
Customizing the TrackPoint	44
Increasing memory	49
Installing the DIMM	50
Removing the DIMM	54
Upgrading the hard disk drive	55

Attaching an external mouse, keypad, or keyboard . . . . .	59
Attaching an external mouse or numeric keypad . . . . .	59
Attaching an external keyboard and mouse . . . . .	61
Enabling the TrackPoint . . . . .	63
Attaching an external monitor . . . . .	64
Attaching a television to your computer . . . . .	68
Using the dual display function . . . . .	71
Installing a PC Card . . . . .	75
Removing the PC Card . . . . .	77
Using a docking station . . . . .	78
Cold docking . . . . .	79
Cold undocking . . . . .	81
Hot or warm docking . . . . .	81
Hot or warm undocking . . . . .	82
Presetting a device to avoid a resource conflict . . . . .	83
Enabling the IDE drive on the docking station . . . . .	84
Replacing an UltralimBay device . . . . .	88
Warm-swapping a device in the UltralimBay . . . . .	89
Attaching the diskette drive externally . . . . .	91
Removing the diskette drive from the enclosure . . . . .	92
<b>Chapter 3. Protecting your computer . . . . .</b>	<b>93</b>
Using passwords . . . . .	94
Entering a password . . . . .	96
Setting a password . . . . .	96
Changing or removing a password . . . . .	99
Using the Personalization Editor . . . . .	105
Entering your personal data . . . . .	105
Deleting the personalization window . . . . .	108
Using locks . . . . .	109
Using the security screw . . . . .	110
<b>Chapter 4. Solving computer problems . . . . .</b>	<b>111</b>
Hints and tips . . . . .	112
Using a docking station . . . . .	114
Using the USB connector . . . . .	114
Using the DVD-ROM drive . . . . .	115
Using a PC Card . . . . .	115
Using a second CardBus card . . . . .	116
Using a microphone . . . . .	116
Troubleshooting guide . . . . .	117



Troubleshooting charts . . . . .	118
Error codes or messages . . . . .	119
No error codes or messages . . . . .	125
Input problems . . . . .	125
Suspend or hibernation problems . . . . .	127
LCD problems . . . . .	131
Indicator problems . . . . .	132
Battery problems . . . . .	132
A hard-disk-drive problem . . . . .	133
CD-ROM drive problems . . . . .	134
DVD drive problems . . . . .	135
Infrared communication problems . . . . .	137
Audio or telephony problems . . . . .	138
A universal serial bus (USB) problem . . . . .	139
PC Card or PCI modem problems . . . . .	139
Other PC Card problems . . . . .	141
Docking station or port replicator problems . . . . .	143
A printer problem . . . . .	147
External monitor problems . . . . .	147
A television problem . . . . .	151
Other option problems . . . . .	152
Software problems . . . . .	153
Other problems . . . . .	153
Testing your computer . . . . .	155
<b>Appendix A. Features and specifications . . . . .</b>	<b>157</b>
Features . . . . .	157
Specifications . . . . .	159
IBM power cords . . . . .	160
<b>Appendix B. Product warranty and notices . . . . .</b>	<b>163</b>
Notices . . . . .	165
Year 2000 readiness and instructions . . . . .	165
Trademarks . . . . .	166
Electronic emission notices . . . . .	167
Telecommunication notice . . . . .	169
Product notice requirements . . . . .	172
Notice for Australia . . . . .	172
<b>Index . . . . .</b>	<b>173</b>

## About this book

This book contains information that will help you operate the IBM ThinkPad 600X computer. Before using the computer, be sure to read the *ThinkPad Setup Guide* and Chapter 1 of this book.

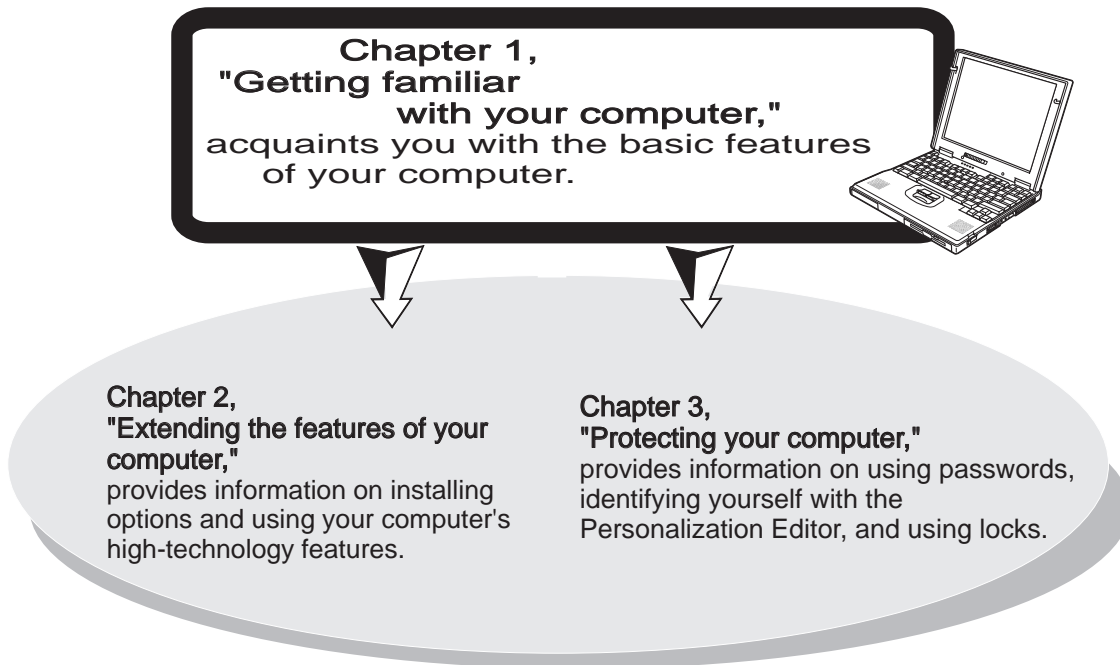

**Chapter 4, "Solving computer problems,"**  
describes what to do if you have a computer problem. The chapter includes a troubleshooting guide.

**Appendix A, "Features and specifications,"** describes the features and specifications associated with your computer, including information on power cords.

**Appendix B, "Product warranty and notices,"** contains the warranty statement for your computer and notices for this book.

The book concludes with an **index**.

## Icons used in this book

For procedures or information unique to the operating system installed in your computer:



Information for Microsoft®  
Windows® 98 users



Information for Microsoft  
Windows NT users



Information for Microsoft  
Windows 95 users



For information about using Windows 3.1, OS/2 Warp,  
or DOS → <http://www.ibm.com/thinkpad/>

## Safety information

These are important safety instructions.



**Electric current from power, telephone, and communication cables is hazardous. To avoid shock hazard, connect and disconnect cables as shown below when installing, moving, or opening the covers of this product or attached devices. The 3-pin power cord must be used with a properly grounded outlet.**

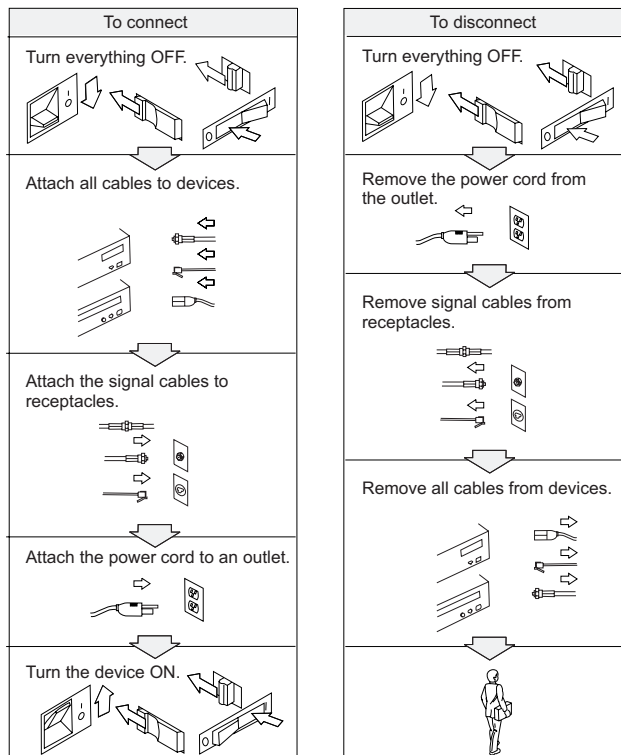



Reduce the risk of fire and electric shock by always following basic safety precautions, including the following:

- Do not use your computer in or near water.
- During electrical storms:
  - Do not use your computer with the telephone cable connection.
  - Do not connect the cable to or disconnect it from the telephone outlet on the wall.



There is a danger of an explosion if the rechargeable battery pack is incorrectly replaced. The battery pack contains a small amount of harmful substances. To avoid possible injury:

- Replace only with a battery of the type recommended by IBM, or an equivalent.
- Keep the battery pack away from fire.
- Do not expose it to water or rain.
- Do not attempt to disassemble it.
- Do not short-circuit it.
- Keep it away from children.

Do not put the battery pack in trash that is disposed of in landfills. When disposing of the battery, comply with local ordinances or regulations and your company's safety standards. In the United States, call IBM at 1-800-IBM-4333 for information on disposal.



There is a danger of an explosion if the backup battery is incorrectly replaced.

The lithium battery (IBM P/N 02K6502 UL-recognized component [file no. MH12210]) contains lithium and can explode if it is not properly handled or disposed of.

Replace only with a battery of the same type.

To avoid possible injury or death, do not: (1) throw or immerse the battery into water, (2) allow it to heat to more than 100°C (212°F), or (3) attempt to repair or disassemble it. Dispose of it as required by local ordinances or regulations and your company's safety standards.

**CAUTION:**

The fluorescent lamp in the liquid crystal display (LCD) contains mercury. Do not put it in trash that is disposed of in landfills. Dispose of it as required by local ordinances or regulations.

The LCD is made of glass, and rough handling or dropping the computer can cause the LCD to break. If the LCD breaks and the internal fluid gets into your eyes or on your hands, immediately wash the affected areas with water for at least 15 minutes; if any symptoms are present after washing, get medical care.

**CAUTION:**

To reduce the risk of fire, use only No. 26 AWG or larger (thicker) telephone cable.

## Laser compliance statement

The CD-ROM or DVD drive, which can be installed in the IBM ThinkPad 600X, is a laser product. The drive's classification label (shown below) is on the surface of the drive.

CLASS 1 LASER PRODUCT  
LASER KLASSE 1  
LUOKAN 1 LASERLAITE  
APPAREIL A LASER DE CLASSE 1  
KLASS 1 LASER APPARAT

The drive is certified in the U.S. to conform to the requirements of the Department of Health and Human Services 21 Code of Federal Regulations (DHHS 21 CFR) Subchapter J for Class I laser products.

In other countries, the drive is certified to conform to the requirements of EN60825.



**Do not open the CD-ROM or DVD drive unit; no user adjustments or serviceable parts are inside.**

**Use of controls, adjustments, or the performance of procedures other than those specified might result in hazardous radiation exposure.**

Class 1 laser products are not considered hazardous. The design of the laser system and the CD-ROM or DVD-ROM drive ensures that there is no exposure to laser radiation above a Class 1 level during normal operation, user maintenance, or servicing.

Some drives contain an embedded Class 3A laser diode. Note this warning:



**Emits visible and invisible laser radiation when open.  
Avoid direct eye exposure. Do not stare into the beam  
or view it directly with optical instruments.**



## Handling the ThinkPad computer

By using common sense and by following these handling tips, you will get the most use and enjoyment out of your computer for a long time to come.

This section provides tips for handling notebook computers in general. Some descriptions might not suit your situation. Check your shipping checklist to confirm the items you get with your computer.

Notebook computers are precision machines that require careful handling. Though your computer is designed and tested to be a durable notebook computer that functions reliably in normal work environments, you need to use some common sense in handling it.

### ThinkPad don'ts

- Do not subject your computer to physical punishment, such as dropping or bumping.
- Do not place heavy objects on your computer.
- Do not spill or allow liquids into your computer.
- Do not use your computer in or near water (to avoid the danger of electrical shock).
- Do not pack your computer in a tightly packed suitcase or bag. Your LCD might be damaged.

A scratchlike marking on your LCD might be a stain transferred from the keyboard (including from the TrackPoint stick) when the cover was pressed from the outside. Wipe such a stain gently with a dry soft cloth. If the stain remains, moisten the cloth with LCD cleaner and wipe the stain again. Be sure to dry the LCD before closing it.

- Do not disassemble your computer. Only an authorized IBM ThinkPad repair technician should disassemble and repair your computer.
- Do not scratch, twist, hit, or push the surface of your computer display.
- Do not place any objects between the display and the keyboard or under the keyboard.

- Do not pick up or hold your computer by the display. When picking up your open computer, hold it by the bottom (keyboard) half.
- Do not modify or tape the latches to keep the display open or closed.
- Do not turn your computer over while the AC Adapter is plugged in. This could break the adapter plug.
- Do not move the computer when the hard disk drive is accessing data (when the indicator is blinking).
- Do not use or store your computer where the temperature is below 5° C or above 35° C (41° F and 95° F).
- Do not place your computer closer than 13 cm (5 in.) from any electrical appliance that generates a strong magnetic field, such as a motor, a magnet, a TV, a refrigerator, or large audio speakers.
- Do not put an operating cellular phone on the computer. The phone might cause a computer system malfunction.
- Do not hard-mount your computer in a vehicle or anywhere that it is subject to strong vibration.
- Do not crush, drop, or physically punish the external or removable hard disk, diskette, or CD-ROM drive when it is outside your computer.
- Do not press on the middle part of the diskette drive or the CD-ROM drive.
- Do not insert a diskette at an angle. Not inserting the diskette straight into the drive can damage the drive.
- Do not place more than one label on a diskette, and do not allow the label to be loose. Multiple or loose labels can detach or tear and then lodge in the drive.
- Do not touch the lens on the CD-ROM tray.
- Do not close the CD-ROM tray until you hear the CD-ROM click into the center pivot of the CD-ROM drive.
- Do not touch the surface of a compact disc; handle the compact disc only by its edges.
- Do not connect the modem to a PBX (private branch exchange) or other digital telephone extension line. **Your computer can use only a public-switched telephone network (PSTN).** Use of a phone line other than PSTN can damage your modem. If you are not sure which kind of phone line you are using, contact your telephone company. Many hotels or office

buildings use digital telephone extension lines, so check before connecting the telephone cable in such places.

- Do not leave the base of your computer in contact with your lap or any part of your body for an extended period when the computer is functioning or when the battery is charging. Your computer dissipates some heat during normal operation. This heat is a function of the level of system activity and battery charge level. Extended contact with your body, even through clothing, could cause discomfort or, eventually, a skin burn.

## ThinkPad do's

Treat your computer like precision electronic machinery.

- When installing your hard disk, diskette, or CD-ROM drive, follow the instructions in this online book and apply pressure only where needed on the device.
- When installing the CD-ROM or diskette drive into the UltralimBay, make sure the AC Adapter is disconnected from your computer.
- If you exchange drives in your computer, reinstall the plastic bezel faces (if supplied).
- Store your external and removable hard disk, diskette, and CD-ROM drives in the appropriate container or packaging when they are not being used.
- Choose a quality carrying case that will protect your computer.
- Store packing materials safely out of reach of children to prevent the risk of suffocation from plastic bags.
- Register your ThinkPad products with IBM (refer to the *Setup Guide*). This can help authorities return your computer to you if it is lost or stolen. Registering your computer also enables IBM to notify you about possible upgrades.
- Check the IBM Web pages (<http://www.ibm.com/thinkpad/>) periodically to get current information about your computer.

## Cleaning your computer

Occasionally clean your computer as follows:

- Use a soft cloth moistened with nonalkaline detergent to wipe the exterior of the computer.
- Don't spray cleaner directly on the display or keyboard.
- Gently wipe the LCD with a dry, soft cloth.

## Carrying your computer

When carrying your computer, follow these instructions to prevent possible damage to your computer and data:

1. Remove any media from the CD-ROM drive or diskette drive.
2. Turn off all attached devices.
3. Power off the computer, or enter suspend or hibernation mode; then close the LCD. Make sure the suspend indicator is on when the computer is in suspend mode, or the power indicator is off when it is powered off or in hibernation mode.
4. Unplug all external cables and cords connected to your computer.
5. Make sure all computer doors and covers are closed.
6. Use a quality carrying case that provides adequate cushion and protection.

Do not move the computer when the hard disk drive is accessing data—that is, when the indicator is blinking. Make sure the indicator is off before you carry the computer.

## Extending the life of your computer's battery

The amount of battery power consumed by your computer depends on such conditions as the frequency of use, the operating temperature, and the period in storage (if unused). The following tips can help you to extend the life of your battery:

- Do not charge the battery pack until all of its power is used. Recharging a battery pack that is not completely discharged can shorten battery life.
- Once you start charging the battery pack, do not use it until it is fully charged.
- Whenever possible, use the ThinkPad battery power-saving modes:
  - **Standby**
  - **Suspend**
  - **Hibernation**

For more information → *Online User's Guide*.

- Decrease the LCD brightness.
- Use Advanced Power Management (APM). Each operating system comes with its own power management.

- If the internal serial devices—the modem, the serial port, and the infrared port—are not in use, stop the supply of power to them.
- If you will not be using the computer for a long period, remove the battery pack and keep it in a cool place.





# Chapter 1

## Getting familiar with your computer



This chapter provides basic information about your computer.

**Note**

To power off the computer, hold the power switch for just a second and release it. Wait at least 5 seconds before powering on again or resuming normal operation from suspend or hibernation mode.

Identifying the hardware features	2
System-status indicators	6
Functions of your computer	8
Keyboard functions	8
TrackPoint	8
Fn key	11
Numeric keypad	14
UltraslimBay	15
ThinkPad Utility programs	16
Easy-Setup	16
ThinkPad Configuration program	25
Online User's Guide	29
Backing up your system	30
Recovering lost or damaged software	30
Using the Software Selections CD	30
Using the Recovery CD	32
ConfigSafe	34
ThinkPad Web site	35
Replacing the battery pack	36
Getting service	38
Help at the ThinkPad Web site	38
Help by telephone	39
Recording sheets	40

Identifying the hardware features

# Identifying the hardware features

Front view

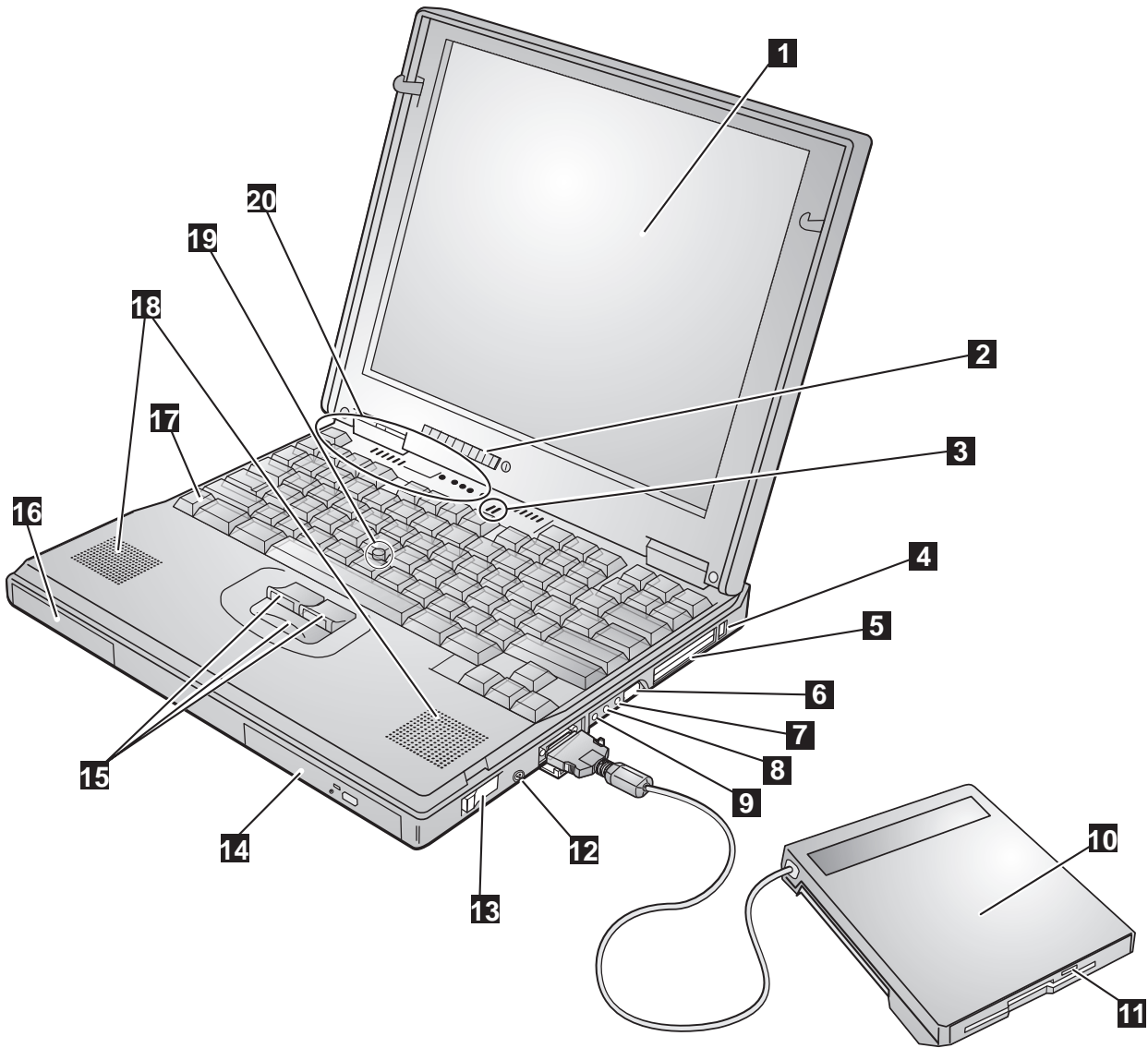



## Identifying the hardware features

- 1** The **color LCD screen** displays computer output.
- 2** The **brightness control** adjusts the brightness of the display.
- 3** The **built-in microphone** captures sound and voice when it is used with an application program capable of handling audio.
- 4** The **PC Card eject buttons** eject the PC Card from the PC Card slot.
- 5** The **PC Card slots** accept PC Cards.
- 6** The **infrared port** enables the computer to communicate with other devices that have infrared data-transfer capability.
- 7** The **headphone jack**, a  $\frac{1}{8}$ -inch (3.5-mm) diameter jack, is where you connect a stereo headphone or external speakers.
- 8** The **line-in jack**, a  $\frac{1}{8}$ -inch (3.5-mm) diameter jack, is where you connect an external stereo audio device.
- 9** The **microphone jack**, a  $\frac{1}{8}$ -inch (3.5-mm) diameter jack, is where you connect a microphone.
- 10** If another device is in the UltralimBay, you can attach the diskette drive as an **external diskette drive**.
- 11** The **diskette-eject button** ejects the diskette from the diskette drive.
- 12** The **video-out connector** is used for connecting your computer to a television or a VCR for sending video images to these devices. Your computer might not have this connector.
- 13** The **LCD latch** opens the LCD when pressed.
- 14** The **UltralimBay** accepts storage devices such as a CD-ROM or DVD-ROM drive. (→ page 15.)
- 15** The **click buttons** work with the TrackPoint **19** and provide functions similar to those of mouse buttons.
- 16** The **hard disk drive** is built into the computer.
- 17** The **Fn key** is used with the function keys to activate the **Fn** key functions.
- 18** The left and right **internal speakers** generate stereo sound.
- 19** The **TrackPoint** is a built-in pointing device that provides a function similar to that of a mouse.
- 20** The **system-status indicators** with their associated symbols show the system status. (→ page 6.)

*Identifying the hardware features*

**Rear view**

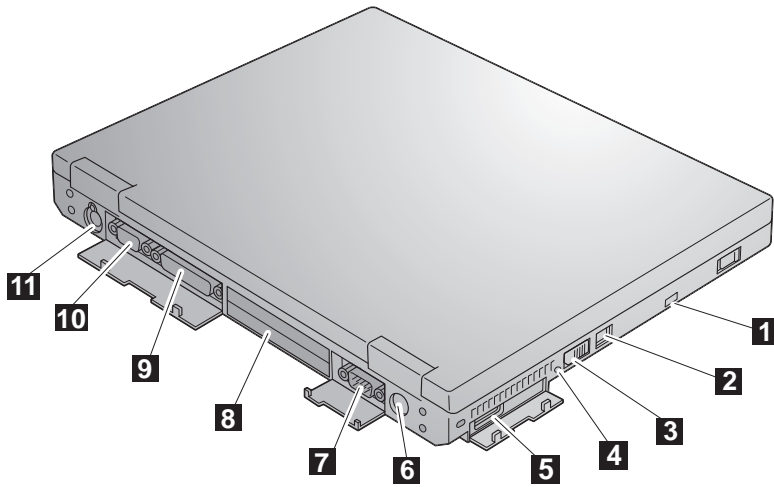

**Bottom view**

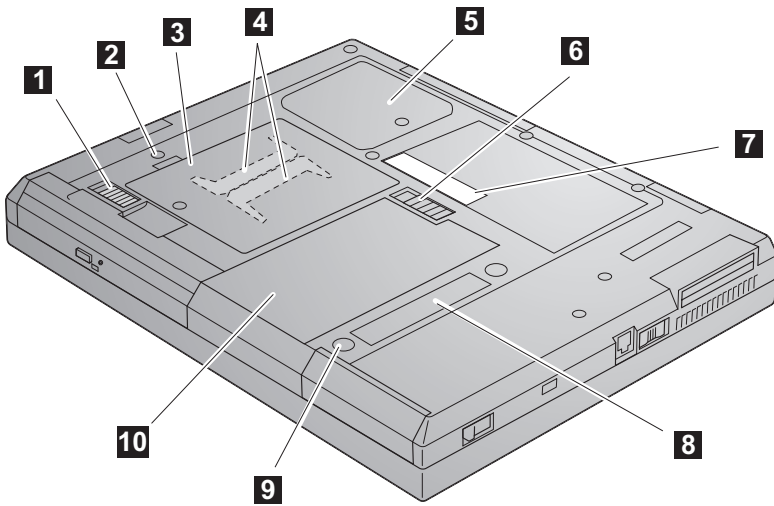

## Identifying the hardware features

### Rear view of the computer

- 1** The **security keyhole** is used with a mechanical lock.
- 2** The **modem connector** is used for connecting your computer to a telephone line.
- 3** The **power switch** turns the computer on and off.
- 4** The **reset switch** is used to power the computer off if an application hangs or if the computer does not accept any input. Use the tip of a pen to press this switch.
- 5** The **universal serial bus (USB) connector** enables you to connect any device that conforms to the USB interface. Many recent digital devices comply to this new standard.
- 6** The **power jack** is where the AC Adapter cable is connected.
- 7** The **serial connector** is where you connect a 9-pin, serial-device cable.
- 8** The **system-expansion connector** (240-pin) enables you to connect a port replicator.
- 9** The **parallel connector** is where you connect a parallel-printer signal cable.
- 10** The **external-monitor connector** is where you attach an external monitor (CRT).
- 11** The **external-input-device connector** is used to attach a mouse or an external numeric keypad to the computer. An external keyboard can be attached to this connector through an optional keyboard/mouse cable.

### Bottom view of the computer

- 1** The **UltraslimBay device lock** is a lock for the device in the UltraslimBay.
- 2** When the **bay LED** is on, the system is in use. Do not remove a bay device.
- 3** The **memory-slot cover** covers the memory slot.
- 4** Each of the **memory slots** accepts an SDRAM dual inline memory module (DIMM) option.
- 5** The **Mini-PCI modem slot cover** covers the modem card slot.
- 6** The **battery-pack latch** locks or releases the battery pack.
- 7** The **serial number label** identifies your computer. You need this number to get help.
- 8** Put your name plate here.
- 9** To install or remove the hard disk, loosen this **hard disk drive screw**. You can use the security screw shipped with your computer as a hard disk screw.
- 10** The **battery pack** is a built-in power source for the computer.





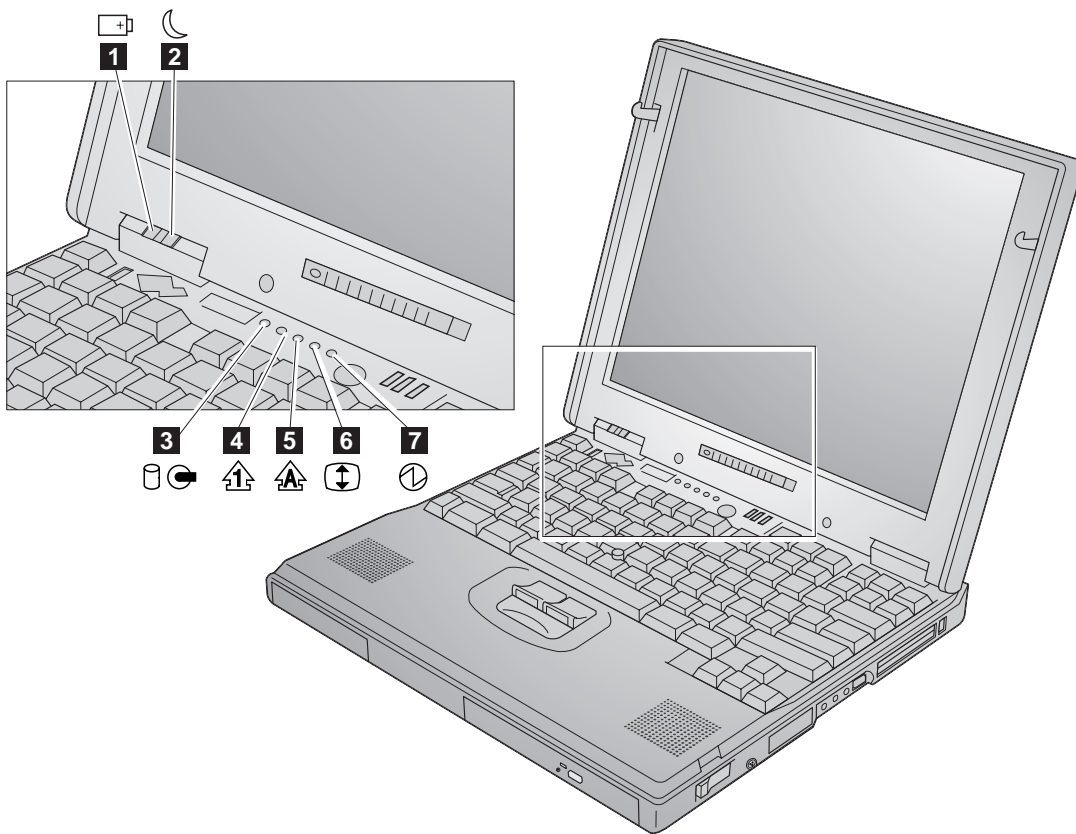

## System-status indicators

# System-status indicators

The system-status indicators on the computer show the current status of your computer by their on or off states and by their colors, green and orange. Each indicator is identified with a symbol. The following shows the location and the meaning of each icon:



## System-status indicators

Symbol	Color	Meaning
<b>1</b> Battery status 	Green	Enough battery power remains for operation.
	Blinking orange	The battery pack needs to be charged. When the indicator starts blinking orange, the computer beeps three times.
	Orange	The battery pack is being charged.
<b>2</b> Suspend mode 	Green	The computer is in suspend mode. (→ <i>Online User's Guide.</i> )
	Blinking green	The computer is entering suspend or hibernation mode or is resuming normal operation.
<b>3</b> Hard disk in use 	Orange	Data is being read from or written to the hard disk or read from DVD or CD-ROM drive. <i>Do not enter the computer into suspend mode or power off the computer when this indicator is on.</i>
<b>4</b> Numeric lock 	Green	The numeric keypad on the keyboard is enabled. You enable or disable the keypad by pressing and holding the <b>Shift</b> key, and pressing the <b>NumLk</b> key. For details → “Numeric keypad” on page 14.
<b>5</b> Caps lock 	Green	Caps Lock mode is enabled. All alphabetic characters (A–Z) are entered in capital letters without the <b>Shift</b> key being pressed. You enable or disable Caps Lock mode by pressing the <b>Caps Lock</b> key.
<b>6</b> Scroll lock 	Green	Scroll Lock mode is enabled. The <b>Arrow</b> keys can be used as screen-scroll function keys. The cursor cannot be moved with the <b>Arrow</b> keys. <i>Not all application programs support this function.</i> You enable or disable Scroll Lock mode by pressing the <b>ScrLk</b> key.
<b>7</b> Power on 	Green	The computer is operational. This indicator is on when the computer is on and not in suspend mode.

## Functions of your computer

This section describes the following features:

- Keyboard functions
- UltralimBay
- ThinkPad utilities
- The *Online User's Guide*

### Keyboard functions

Your computer's keyboard has the following functions:

- TrackPoint
- **Fn** key
- Numeric keypad

#### *TrackPoint*

The keyboard contains a unique cursor-pointing device called the *TrackPoint*. Pointing, selecting, and dragging all become part of a single process you can perform without moving your fingers from their typing position.



You can set the following features by customizing the TrackPoint:

- Press-to-Select
- Sensitivity
- Scrolling or Magnifying Glass

For more information → “Customizing the TrackPoint” on page 44.

## Functions of your computer

The TrackPoint consists of a **stick** on the keyboard and three **click buttons** below the keyboard. Movement of the cursor on the screen is controlled by the amount of pressure that you apply to the nonslip cap on the stick in any direction parallel to the keyboard; the stick itself does *not* move. The speed at which the cursor moves corresponds to the pressure you apply to the stick. The functions of the left and right click buttons correspond to those of the left and right mouse buttons on a traditional mouse; these functions depend on the software you are using. The function of the center button is described on page 47.

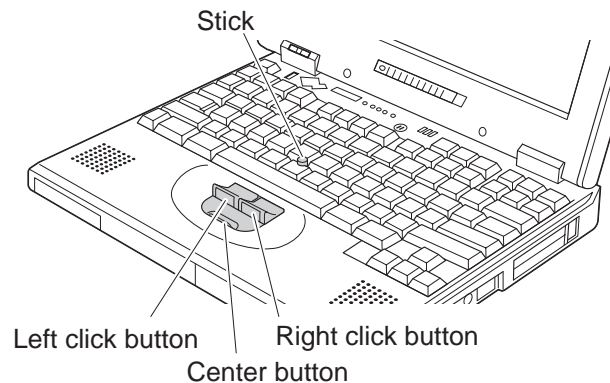

If you are not familiar with using the TrackPoint, these instructions will help you get started:

- 1** Place your hands in the typing position. With either index finger, press gently on the stick in the direction you want the cursor to move.

Pressing the stick away from you moves the cursor up the screen; pressing it toward you moves the cursor down the screen. You can also move the cursor side to side by pressing sideways.



The cursor might drift. This is not a defect. Do not use the TrackPoint until the cursor stops moving.

## Functions of your computer

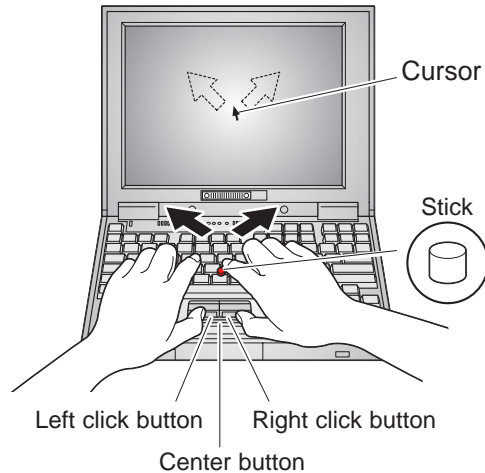

- 2** Press the left and right click buttons with either thumb to select and drag as required by your software.

By enabling Press-to-Select, you can make the TrackPoint stick function the same as the left or right click button. For more information → “Customizing the TrackPoint” on page 44.



### Changing the cap

The cap **1** on the end of the TrackPoint stick is removable. You can replace it with one of the spares shipped with your computer.

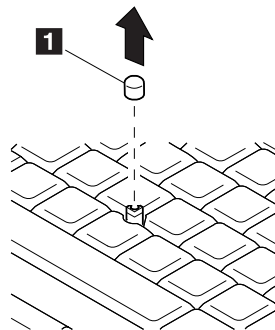



## Functions of your computer

### Fn key

The **Fn** key function enables you to change operational features instantly. When you use the following functions, press and hold the **Fn** key **1**; then press the appropriate function key **2** (**F1** to **F12**, **PgUp**, **PgDn**, or **BackSpace**).

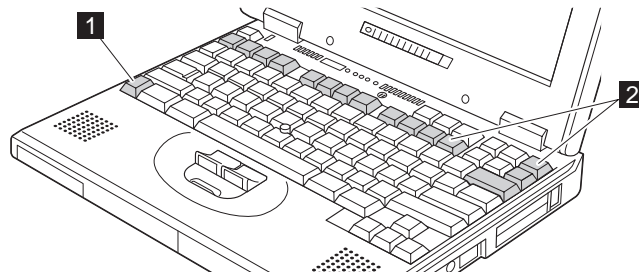

#### The Fn key lock function

The following setup gives you the same effect as when you press and hold the **Fn** key and then press an appropriate function key.











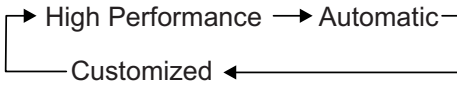

Start the ThinkPad Configuration program. (➡ “ThinkPad Configuration program” on page 25.) Click the **Accessibility** (♿) button, and click **Enable** for **Fn key lock**. You can also set up by typing `PS2 FNS E` at the command prompt.

After you enable the **Fn** key lock and press **Fn** *once*, press one of the function keys. The computer works the same as when you press **Fn** + the function key.

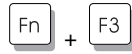





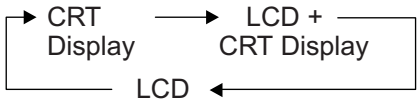



If you press **Fn** *twice* after enabling the lock, pressing a function key alone is recognized as a combination of **Fn** + that function key. To stop this function, press **Fn** again.

## Functions of your computer

The following table shows the function of the **Fn** key combined with other keys:

Feature and icon	Key combination	Meaning
<b>Power mode functions</b>		
Fuel-Gauge display on or off 	 (Only for Windows users)	If you press this key combination, the window for the battery status appears or disappears. You can set parameters for battery status in the window.  <b>Note:</b> The Fuel-Gauge program must be activated before you can use this key combination.  To activate the Fuel-Gauge program, do the following: <ol style="list-style-type: none"> <li>1. Click <b>Start</b>.</li> <li>2. Move the cursor to <b>Programs, ThinkPad</b>, and then click <b>Fuel</b>.</li> </ol>
Power mode switching 		The power mode changes as follows: 
<b>Power conservation functions for battery power</b>		
Standby mode 		The computer enters standby mode. For more information about this mode → <i>Online User's Guide</i> .
Suspend mode 		The computer enters suspend mode. For more information about this mode → <i>Online User's Guide</i> .
Hibernation mode 		The computer enters hibernation mode. For more information about this mode → <i>Online User's Guide</i> .
<b>Other functions</b>		
Switching between the LCD and the external monitor 		Computer output is displayed in the following order when an external monitor (CRT) is attached.   <b>Note:</b> If a television is the secondary display in the dual display function or used as a simultaneous display, switching with these keys is not supported.

## Functions of your computer

Feature and icon	Key combination	Meaning
Screen expansion	 + 	The LCD screen image size switches between expanded and normal mode if your LCD image is smaller than the physical LCD.
Volume up 	 + 	The volume increases.
Volume down 	 + 	The volume decreases.
Mute 	 + 	Sound turns off. <b>Notes:</b> <ol style="list-style-type: none"><li>1. This function is not disabled when you power off the computer and power it on again.</li><li>2. To turn on the sound, press <b>Fn + PgUp</b> or <b>Fn + PgDn</b>.</li></ol>



If the computer is in suspend mode and you press the **Fn** key independently without any function key, the computer returns to normal operation.

## Functions of your computer

### Numeric keypad

When the external keyboard or the external numeric keypad is attached to the computer, the numeric keypad on the computer is not active. You can enable certain keys on the keyboard to work as if they were a 10-key numeric keypad. To enable these keys, press and hold **Shift** and then press **NumLk**. To disable them, repeat the procedure.

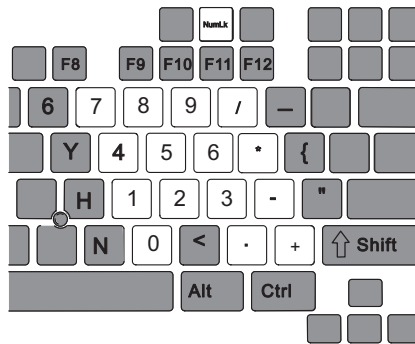

While this “numeric keypad” is enabled, you might need to use the cursor- and screen-control keys temporarily. To do this, press and hold **Shift**.



The functions of the cursor- and screen-control keys are not printed on the keys.

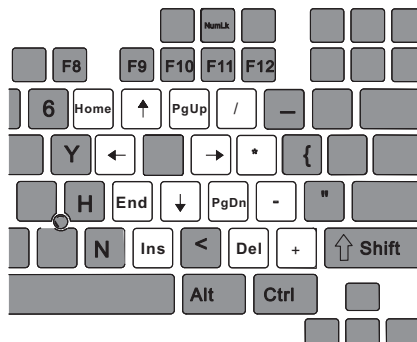

## UltraslimBay

Your ThinkPad 600X computer has an UltraslimBay.



You can install one of the following in the UltraslimBay:

- Weight-saver bezel
- Diskette drive
- DVD drive
- CD-ROM drive
- LS-120 drive
- Secondary hard disk drive adapter
- Secondary battery
- Zip 100-MB UltraslimBay drive

For the detailed information about these devices, refer to the manuals shipped with them.

To replace a device in the UltraslimBay → “Replacing an UltraslimBay device” on page 88.

To attach the diskette drive externally → “Attaching the diskette drive externally” on page 91.

## ThinkPad Utility programs

Your computer has the following utility programs for easy configuration:

- Easy-Setup
- ThinkPad Configuration program

This section summarizes these utility programs.

### Easy-Setup

Your computer provides a user-friendly program called *Easy-Setup*, which enables you to select various setup parameters:

- **Config:** Set the configuration of your computer.
- **Date/Time:** Set the date and time.
- **Password:** Set a password.
- **Start up:** Set the startup device.
- **Restart:** Restart the system.

To start Easy-Setup, do as follows:

- 1** Power off the computer, and remove any diskette from the diskette drive.
- 2** Press and hold **F1**; then power on the computer. Hold **F1** until the “Easy-Setup” menu appears.

If you have set a password, the “Easy-Setup” menu appears after you enter the password.

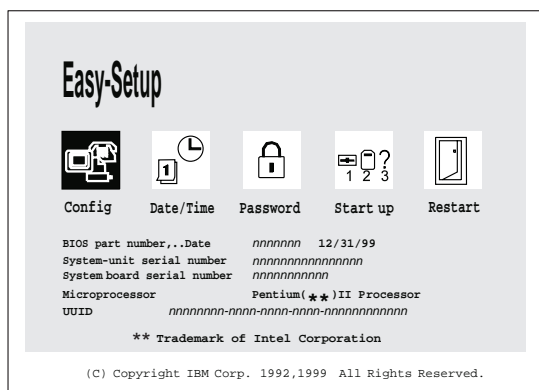

## Functions of your computer

**3** Move to an icon you want to change, using the arrow keys or the TrackPoint, and click the icon.

A submenu is displayed.

**4** Change the items you wish to change.

**5** Click **Exit** to exit from the submenu.

**6** Click **Restart** to exit from the “Easy-Setup” menu.

Your computer restarts.



### Changing the screen color

You can change the color of the “Easy-Setup” menu by pressing the **Ctrl+PgUp** keys or by pressing the **Ctrl+PgDn** keys.

To return to the original color, press the **Ctrl+Home** keys.

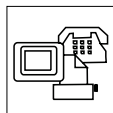

Config

Clicking the **Config** button displays the following configuration submenu:

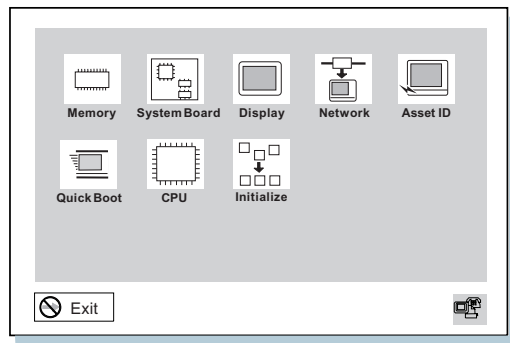

The **Memory** button shows the amount of memory installed and available.



The **System Board** button provides information on the system board installed.

## Functions of your computer



The **Display** button sets the screen output to be displayed either with a **single** video subsystem or with **multiple** video subsystems. You can use this function only when you are using a docking station in which a video adapter card has been installed. If you select **Single**, the video adapter card in your docking station is enabled. If you select **Multiple**, both the built-in video system and the video adapter card in your docking station are enabled under the multiple display environment. If you choose **Multiple** and do not use the multiple display function, only the built-in video system is enabled.



The **Network** button enables or disables the Wake-on-LAN function (option) or the Flash-over-LAN function (option). You can use these functions only with a docking station.



The **Asset ID** button enables or disables the Antenna Security or the Gate Security. Selecting **Antenna** prevents the RFID option from being removed from your computer; selecting **Gate** prevents your computer from being taken out through a portal gate. These security functions are supported in specified models and are effective only when the supervisor password is set.



The **Quick Boot** button enables or disables the Simple Boot Flag function.



### Simple Boot Flag function

This function automatically optimizes the behavior and boot performance of the BIOS and operating system, for the installed operating system and previous boot.

If this function is **Enabled** and a Plug-and-Play-capable operating system, such as Windows 98, is installed, the system BIOS does not configure such hardware resources as system interruptions, memory windows, and I/O port ranges for all the devices in the system.

**If you are going to use an operating system that is not Plug-and-Play-capable, disable this function so that the BIOS will configure hardware resources.**



## Functions of your computer



The **CPU** button enables or disables the serial number on the CPU.



The **Initialize** button sets all device settings to their default values.

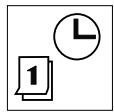

Date/Time

Clicking the **Date/Time** button displays the following date-and-time submenu, which you can use to set the current date and time:

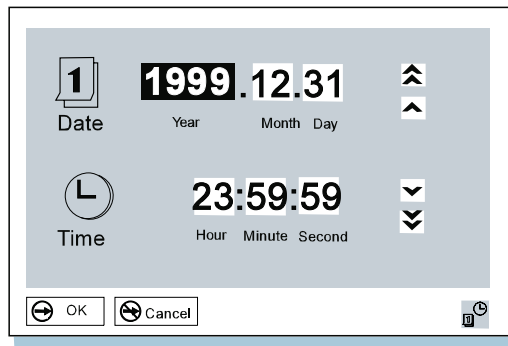

To change the date and time, do the following:

- 1 Move the cursor to any field (Year, Month, Day, Hour, Minute, Second); then type the date and time.



Instead of typing, you can place the pointer on any of the arrow icons (⬆️, ⬇️, ⬆️, or ⬇️) to adjust the date and time.

Clicking the double-arrow icon scrolls the numbers faster.

- 2 Click **OK** to save the changes or **Cancel** to cancel them.

## Functions of your computer



Password

Clicking the **Password** button displays the password submenu, which you can use to set passwords:



Selecting this icon displays a submenu for setting the **power-on** password.



Selecting this icon displays a submenu for setting the **hard-disk-drive (HDD)** password.



Selecting this icon displays a submenu for setting the **supervisor** password.

For more information on passwords → “Using passwords” on page 94.



An open lock icon shows that a password has not been set yet.

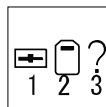

Start up

Clicking the **Start up** button displays the startup submenu, which you can use to change the startup or boot sequence.

For example, if you have different operating systems on different replaceable hard disk drives or PC Cards, you can have the system boot up from one of these devices.

## Functions of your computer

To change the startup sequence, do the following:

- 1 Click **Start up** in the “Easy-Setup” menu. The startup submenu appears:

### Attention

After you change your startup sequence, you must be extremely careful not to specify a wrong device during a copy, save, or format operation. If you specify a wrong device, your data and programs might be erased or overwritten.

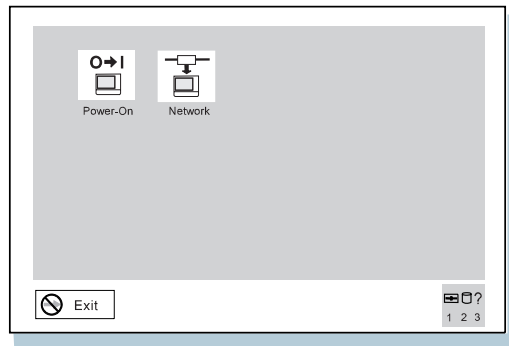

#### Note:



The **Power-On** button sets the startup sequence when the power switch is set to ON.



The **Network** button sets the startup sequence when Wake on LAN is started. Wake on LAN is typically used by LAN administrators in corporate networks to access your computer remotely. You can use this function only with a docking station (option).

- 2 Click **Power-On** or **Network**.

For information on these options, see “The Power-On submenu” on page 22 and “The Network submenu” on page 24.

- 3 Move the cursor to the **Reset** icon, and click it.

- 4 Select the first device you want for the startup sequence; then click it.

You can set up to four devices.

- 5 Click **OK** or press **Enter** to save the changes.

## Functions of your computer

### The Power-On submenu

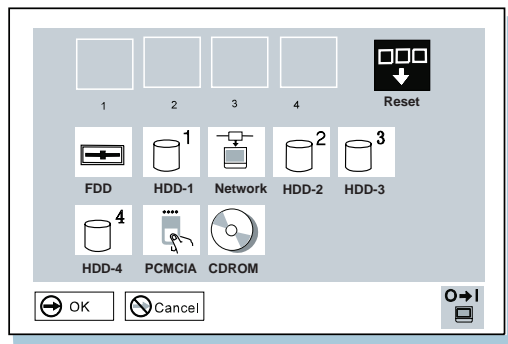

The **FDD** icon is assigned to the diskette drive in the UltralimBay. The diskette drive in the UltralimBay always takes precedence over an external diskette drive. If you don't have a diskette drive in the UltralimBay but you do have the external one on your computer or have one in the docking station, **FDD** is assigned to that diskette drive.

The **HDD-1** to **HDD-4** icons are assigned to each hard disk drive in the following priority:

1. The primary hard disk drive (placed in the hard disk bay of the computer)
2. A hard disk drive in the UltralimBay
3. A hard disk drive in the UltraBay tray of the docking station
4. A hard disk drive in the device space of the docking station
5. A hard disk drive connected to the computer with a SCSI connector

For example, if you don't have a hard disk drive in the computer's UltralimBay but you do have one in the docking station, **HDD-2** is assigned to that hard disk drive.

## ***Functions of your computer***

If you are using a ***remote program loading (RPL) system*** through a token-ring card or some other network card, do the following:

1. Click **Network**. The “Speed” menu appears.
2. If you are using a token-ring card, click the speed you want, **4** or **16**; then press **Enter**.

If you are using a network card other than a token-ring card, such as an Ethernet card, you need not specify the RPL speed. Press **Esc** to exit this menu.

If you select **PCMCIA**, representing, for example, an ATA-3 HDD or a Flash memory card, and cannot start the system, disable the secondary IDE device and restart the system. Some cards might not be compatible with a CD-ROM or DVD-ROM drive.

The **CDROM** icon is assigned to the CD-ROM drive in the UltralimBay. If you don't have a CD-ROM drive in the UltralimBay but you do have one in the docking station, the **CDROM** icon is assigned to the CD-ROM drive. If you have CD-ROM drives in both the UltralimBay and the docking station, the icon is assigned to the CD-ROM drive in the UltralimBay.

## Functions of your computer

### The Network submenu



You can use this function only with a docking station option.

With the **Network** submenu, you can enable or disable the Wake-on-LAN function.

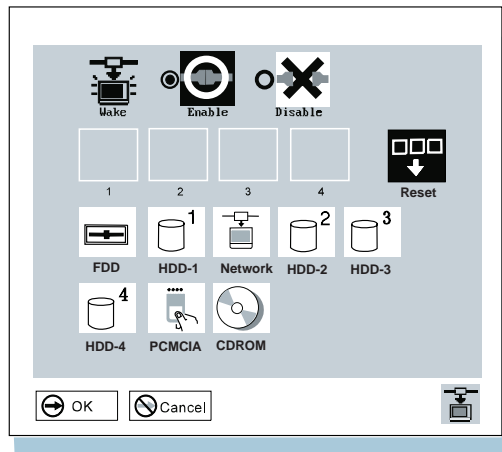

If Wake on LAN is enabled, the network administrator can power on remote machines connected in a LAN using remote network-management software. If your computer is not under system management of a network administrator, disable the function.

For more information → "System Management" in the *Online User's Guide*.

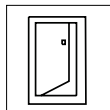

Restart

Pressing the **Restart** button ends the Easy-Setup program and restarts the computer.

### *ThinkPad Configuration program*

#### **Attention**

To get specific details about the ThinkPad Configuration program, click the **Help** button.

The ThinkPad Configuration program enables you to set up and customize the computer's built-in devices to your needs. For example, you can enable or disable a port, switch between your computer's LCD and an external monitor, and set the power management mode.

This section describes how to start the ThinkPad Configuration program.



#### **For Windows 98:**

To start the ThinkPad Configuration program for Windows 98, do as follows:

1. Click **Start** (  ).
2. Move the cursor to **Settings**; then click **Control Panel**.  
The "Control Panel" window appears.
3. Double-click the **ThinkPad Configuration** icon.



You can also start the ThinkPad Configuration program as follows:

- Click **Start** **1**, move the cursor to **Programs**, and **ThinkPad**; then click **ThinkPad Configuration**.
- Find the ThinkPad icon on the bottom right of the taskbar **2**; then double-click the icon.



## Functions of your computer

The following window appears:



- 1** The **Display Device** buttons. Click one of these buttons to set the display output type to the LCD, external monitor (CRT), or both.
- 2** The **Power Scheme** buttons change the preset power options.
- 3** The **Launch Device Manager** button displays the "System Properties" window, where you can make a device available or unavailable.
- 4** The **Show Allocated Resources View** button displays the "Allocated Resources View" window, where you can check the memory addresses and other allocation settings.
- 5** The **Help** button displays online help.
- 6** The **Device** buttons. Click the button of your choice from the window. If the device is enabled, the red indicator next to the button is lit. Otherwise, it stays off.



## Functions of your computer



### For Windows NT:

To start the ThinkPad Configuration program for Windows NT, do as follows:

- 1 Click **Start** at the bottom corner of the screen.
- 2 Move the cursor to **Settings**; then click **Control Panel**.  
The “Control Panel” window appears.
- 3 Double-click the **ThinkPad Configuration** icon.

The following window appears:

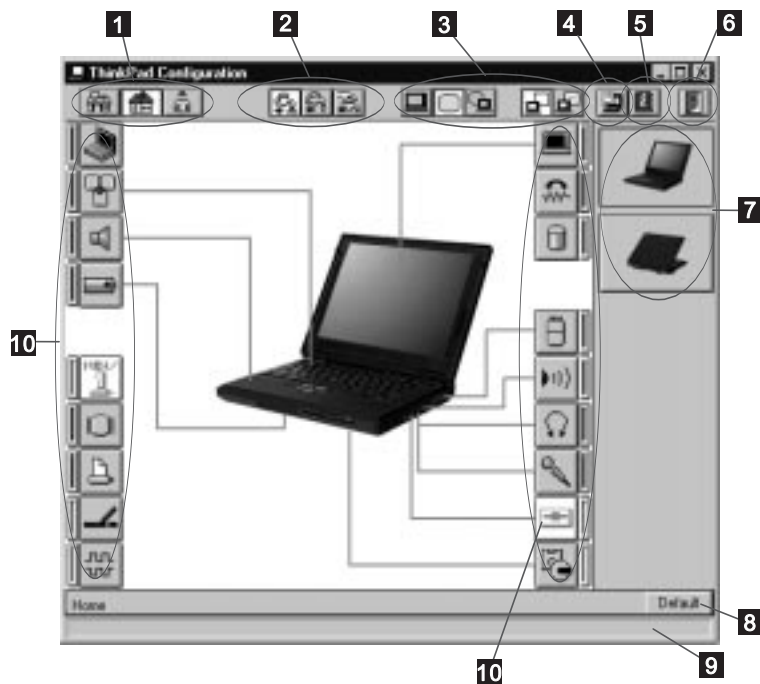

- 1 The **One-Touch Setup** buttons. Click one of these buttons to set the system configuration.
- 2 The **Power Mode** buttons. Click one of these buttons to set the power mode to High Performance mode, Automatic mode, or Customized mode.

## *Functions of your computer*

- 3** The **Display Device** buttons. Click one of these buttons to set the display output type to the LCD, the external monitor (CRT), or both. When making a presentation, you can click the presentation button to disable any system timers, such as the LCD turnoff timer or the power management mode timers.
- 4** The **About** button calls up a display identifying the version of ThinkPad Configuration.
- 5** The **Help** button displays online help.
- 6** The **Exit** button. Click this button to save the changes made and to exit from the ThinkPad Configuration window.
- 7** The **View Angle** buttons. Click the front view or rear view button to display the hardware feature locations.
- 8** The **Default** button. Click this button to set the default values for each option and to cancel the changes you just made.
- 9** The **Status** bar. The device name and its status appear in the status bar when you place the cursor on a device button.
- 10** The **Device** buttons. Click the button of your choice from the window; then set the options for that device from the window that appears. If the device is enabled, the red indicator next to the button is lit. Otherwise, it stays off.

To display only the top part of the window, click the triangular minimize button in the top-right corner.

## Online User's Guide

Your computer features an *Online User's Guide* so that you will always have key information at your fingertips even if you are traveling. It contains the following information:

- Basics:
  - Using your computer outside your home country
  - Using audio, modem, and DVD features
  - Protecting your computer
  - Using your computer with a battery pack
  - Using your computer with a PC Card
  - Frequently asked questions
- Advanced:
  - Resolving system resource conflicts
  - Installing software
  - Using system management
  - Using PS2 commands
  - Using modem commands
  - Hints on using options
- Support info:
  - Finding information in the *Online User's Guide*
  - Finding information in other publications
  - Finding information on the Internet
  - Handling tips and ergonomics information
  - Getting service
  - Glossary

To start the *Online User's Guide*, click **Start** from the Windows main screen, and move the cursor to **Programs** and **ThinkPad 600**; then click **ThinkPad 600 User's Guide**.

The *Online User's Guide* appears. Go to the section you want, and make a printout if necessary.



You can also access the *Online User's Guide* from the IBM Web site → <http://www.ibm.com/thinkpad/>

## *Backing up your system*

# Backing up your system

To back up your system or reinstall the operating system, your ThinkPad computer has the following features:

- The Software Selections CD
- The Recovery CD
- ConfigSafe
- The ThinkPad Web site or bulletin board

## Recovering lost or damaged software

Check the following ThinkPad Web site for the latest information. When updates become available, they will be posted on:

<http://www.ibm.com/thinkpad/>



From this Web site, you can get the driver diskette image for Windows 3.1, OS/2 Warp, or DOS.

### *Using the Software Selections CD*

The Software Selections CD is provided for your convenience during installation; you can customize your system using this CD. It contains all the preinstalled software applications and hardware device drivers for your computer in the Windows 98, Windows 95, or Windows NT environment.

For the device drivers for Windows 3.1, OS/2 Warp, and DOS →

<http://www.ibm.com/thinkpad/>

If you need to reinstall a software application or a hardware device driver, put the Software Selections CD in your CD-ROM or DVD-ROM drive. The features menu appears automatically.

## ***Backing up your system***

The Software Selections CD includes the following features:

- **Welcome**  
This page displays the model and serial number of your computer, and a menu from which you can select an item by clicking it.
- **Install Software**  
Use this page for doing the following:
  - Reinstalling a software application for Windows 98
  - Reinstalling a hardware device driver for Windows 98
  - Installing all hardware device drivers when installing Windows 95
  - Installing all hardware device drivers when installing Windows NT
  - Installing value-added software that was not preinstalled on your computer
- **Uninstall Software**  
You can uninstall any application program or device driver that was installed from the Software Selections CD and that has an uninstall entry in the **Add/Remove Program** list.
- **Advanced Function**
  - **Change Settings**  
You can view the Software Selections CD program text and software products in a language other than the language of your operating system.
  - **Create a Device Driver Diskette**  
You can create a device driver diskette.
  - **Create a Software Selections CD Image**  
You can put the Software Selections CD image on your hard disk drive.
- **Read the License Agreement**  
This page describes the license agreement for the programs.
- **Help**  
This page contains an introduction to the Software Selections CD and explains each item.

## Backing up your system

### Using the Recovery CD

If you accidentally erase your hard disk, you can use the Recovery CD to restore the contents of the preinstalled hard disk to what it was at the time of purchase.

#### Attention

These recovery programs delete all personal data and your customized configuration settings. They reset your computer to most of the factory-shipped default values. Be sure to back up your personal files before you use this CD.

The Recovery CD package consists of a CD-ROM containing the original preinstalled image.

The recovery process might take up to 2 hours.

You need to have a CD-ROM or DVD-ROM drive installed in your computer's UltralimBay. If you have a diskette drive installed in your computer's UltralimBay, replace it with the CD-ROM or DVD-ROM drive (→ "Replacing an UltralimBay device" on page 88).

Your computer supports startable CDs when the startable CD-ROM function is enabled. To use the Recovery CD, enable this function; then recover the system:

- 1** Insert the Recovery CD into the CD-ROM or DVD-ROM drive.
- 2** Power off the computer.
- 3** Power on your computer while pressing and holding the **F1** key.  
Hold the **F1** key until the "Easy-Setup" window appears.
- 4** Click **Start up**.
- 5** Click **Power-on**.
- 6** Click **Reset**.

## *Backing up your system*

**7** Click **CDROM**.

**8** Click **OK**.

**9** Click **Exit**.

The startable CD-ROM function is enabled.

**10** Click **Restart** and then **OK**.

The computer restarts.

**11** Follow the instructions on the screen.

**12** When a completion message appears, remove the Recovery CD from the CD-ROM or DVD-ROM drive.

**13** Power off the computer.

**14** Power on your computer while pressing and holding the **F1** key.

Hold the **F1** key until the “Easy-Setup” window appears.

**15** Click **Start up**.

**16** Click **Power-on**.

**17** Click **Reset**.

**18** Set the startup device and then click **OK**.

**19** Click **Exit**.

**20** Click **Restart** and then **OK**.

Your computer restarts with the preinstalled configuration.

## Backing up your system

### ConfigSafe

ConfigSafe is an application program for Windows 98, Windows 95, or Windows NT that periodically takes *snapshots* of your system files. If your computer does not operate properly after you install a new device driver or software, use ConfigSafe to restore the last working version of your system files. Although it might not make your new hardware or software work, it will set your computer up and running again. This application protects your data.

You can manually take snapshots of your system configuration information. To start the **ConfigSafe**, do the following:

- 1 Click **Start**.
- 2 Move the cursor to **Programs** and **ConfigSafe**.
- 3 Click **ConfigSafe**.

The “ConfigSafe EZ” window appears.

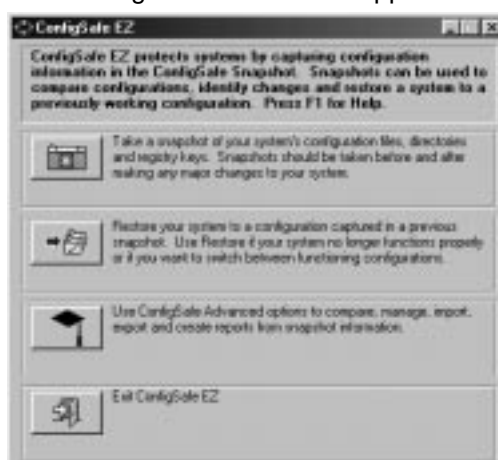

Press **F1** for help on using each function.

For more information about using ConfigSafe → its online help.



## ***Backing up your system***

### **ThinkPad Web site**

IBM supplies all of the latest hardware device drivers and system BIOS for your computer on the ThinkPad Web site at:  
**<http://www.ibm.com/support/>**

Complete a customer profile on the Web site to get the latest updates automatically.

For more information about electronic service and support →  
*Online User's Guide.*

## Replacing the battery pack

# Replacing the battery pack

To replace the battery pack, do as follows:



You can replace the battery when the computer is in hibernation mode. (You cannot replace it when the computer is in suspend mode.) If you are using a PC Card, however, the computer might not be able to enter hibernation mode. If this happens, power off the computer.

- 1** Power off your computer, or enter hibernation mode.
- 2** Disconnect the AC Adapter and cables.
- 3** Close the LCD, and turn the computer over.
- 4** Slide the battery pack latch to the unlocked position **1**; then remove the battery pack **2**.

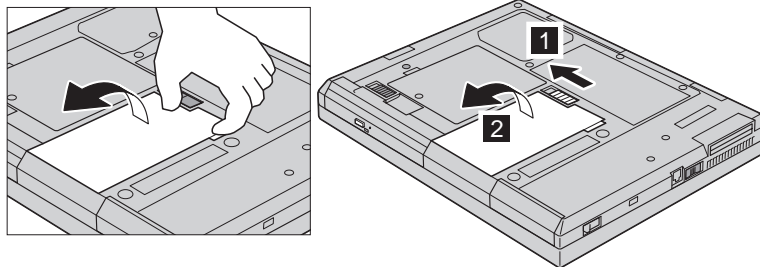

- 5** Align the front of the fully charged spare battery pack with the front side of the battery space in the computer **1**; then put the battery pack in place **2**.

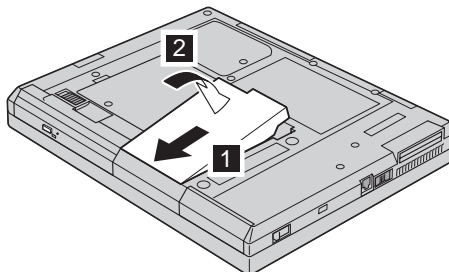

## Replacing the battery pack

- 6 Gently push the battery pack back into the space; then slide the battery pack latch to the locked position.

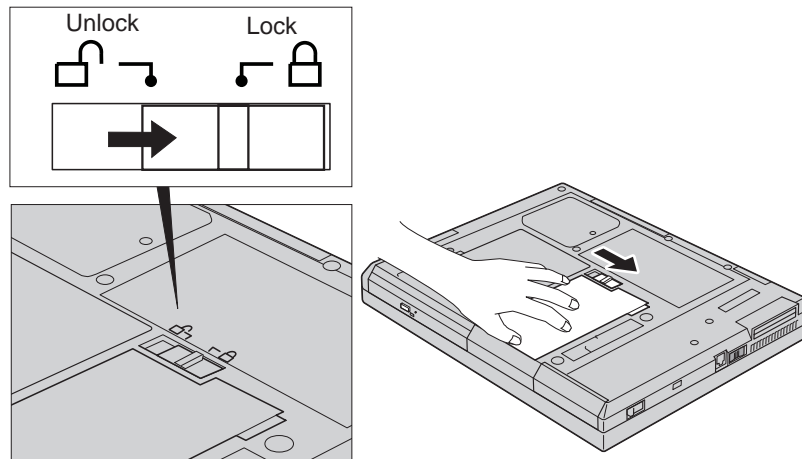

You have finished replacing the battery pack.

## Getting service

# Getting service

Purchasing an IBM PC hardware product entitles you to receive support and services during the limited warranty period. If you need additional support and services, many extended solutions that address most needs are available for purchase.

### About your warranty

During the warranty period, you might be responsible for repair costs if the product damage was due to misuse, accident, modification, unsuitable physical or operating environment, or improper maintenance.

For full information on the product warranty → Appendix B.

You will need to know the following information when requesting repair service:

- Identification number of your computer
- Options installed in your system

**Note:** Use the recording sheet on page 40.

- Error message or problem

**Note:** Error messages can help identify which service action is required and help the service representative provide quick and efficient service.

Use the recording sheet on page 41.

## Help at the ThinkPad Web site

You can get support and information at the ThinkPad Web site.

→ <http://www.ibm.com/support/>

IBM may make improvements or changes to these Web sites at any time without any notice.

## Help by telephone

You can get support and information by telephone during the limited warranty period at no additional charge, through the IBM PC Help Center. Experienced technical-support representatives will be on hand to answer any questions you might have, such as:

- How to set up your computer
- How to install and set up your IBM options purchased directly from IBM or through an IBM reseller
- How to use the 30-day support for the preinstalled operating system
- How to get service
- How to get overnight shipment of customer-replaceable parts

Please have the following information ready when you call:

- Serial number of your computer and proof of purchase
- Description of the problem
- Exact wording of the error message
- Hardware and software configuration information for your system

If possible, be at your computer when you call:

- In the U.S. and Puerto Rico, call 1-800-772-2227.
- In Canada, call 1-800-565-3344.

These lines are available 24 hours a day, 7 days a week. The answering technical-support representative can also fax or mail you technical or product information, such as:

- Product brochures
- Location of IBM resellers
- Services available from IBM

For more information → *Online User's Guide.*

## Recording sheets

### Option list

Fill out the following list with the items that correspond with the features of your computer. If you have two or more devices, note each of them. For example, if you have two DIMMs, select the "DIMM" check box; then note "128 MB x 2."

- |  |                                       |
|--|---------------------------------------|
| <input type="checkbox"/> DIMM _____MB            | <input type="checkbox"/> PC Cards     |
| <input type="checkbox"/> Hard disk drive _____MB | _____                                 |
|  | _____                                 |
| <input type="checkbox"/> External diskette drive | <input type="checkbox"/> Battery pack |
| <input type="checkbox"/> DVD/CD-ROM drive        |                                       |

### Identification numbers

The serial number label is on the bottom of your computer. Write the machine **Type** and the serial number (**S/N**) in the following box:

IBM Product name	ThinkPad 600X
Machine type	2645- _____
Serial number	_____

To determine your computer's serial number → page 4.

**Problem recording sheet**

- Computer information:

Machine type: \_\_\_\_\_

Serial number: \_\_\_\_\_

Date of purchase: \_\_\_/\_\_\_/\_\_\_

- Type of problem:

Continuous problem     Intermittent problem

- Error code:

\_\_\_\_\_

- The operating system and its version number, if available:

Windows 98 Version \_\_\_\_\_

Windows 95 Version \_\_\_\_\_

Windows NT Version \_\_\_\_\_

- Application programs running at the time of the problem:

\_\_\_\_\_  
\_\_\_\_\_

- Problem symptom:

Describe the problem specifically:

\_\_\_\_\_  
\_\_\_\_\_  
\_\_\_\_\_

- Can the problem be reproduced?

Yes     No

If yes, describe how it can be reproduced:

\_\_\_\_\_  
\_\_\_\_\_

***Getting service***





# Chapter 2

## Extending the features of your computer



This chapter provides information about how to customize and extend the ThinkPad features. You can use your computer with external devices and increase its memory.

Customizing the TrackPoint	44
Increasing memory	49
Installing the DIMM	50
Removing the DIMM	54
Upgrading the hard disk drive	55
Attaching an external mouse, keypad, or keyboard	59
Attaching an external mouse or numeric keypad	59
Attaching an external keyboard and mouse	61
Enabling the TrackPoint	63
Attaching an external monitor	64
Attaching a television to your computer	68
Considerations for using the TV-out function	70
Using the dual display function	71
Disabling the dual display	73
Considerations for using a dual display function	74
Installing a PC Card	75
Removing the PC Card	77
Using a docking station	78
Cold docking	79
Cold undocking	81
Hot or warm docking	81
Hot or warm undocking	82
Presetting a device to avoid a resource conflict	83
Enabling the IDE drive on the docking station	84
Replacing an UltralimBay device	88
Warm-swapping a device in the UltralimBay	89
Attaching the diskette drive externally	91
Removing the diskette drive from the enclosure	92

## Customizing the TrackPoint

# Customizing the TrackPoint

You can customize the TrackPoint by doing the following:

**1** Start the ThinkPad Configuration program.

**2** Click the **TrackPoint** button (  ).

**3** Click **TrackPoint Properties....**

The “TrackPoint Properties” window appears:

You can set the following features in this window:

- Press-to-Select
- Sensitivity
- Scrolling or Magnifying Glass

## Setting Press-to-Select



If you enable Press-to-Select by selecting the **Enable Press-to-Select** box, you can make the TrackPoint stick function the same as the left or right click button.

- If you check **Enable dragging**, you can select an item with the TrackPoint stick and then drag the item by putting light pressure on the stick.

## Customizing the TrackPoint

- If you check **Enable Release-to-Select**, you can click by simply lifting your finger quickly off the TrackPoint. Moving the cursor onto an icon and then lifting your finger off the TrackPoint works like clicking. Pressing the TrackPoint again works like double-clicking.
- Click one of the **Press means** radio buttons to select which button the stick will simulate: either the left or the right button. For example, if you select **Left Click**, you can start a program with the TrackPoint by putting the cursor on the program's icon and applying light pressure on the stick.

To adjust the pressing timing of the stick, set **Click Pace**.



If you set the pace too slow, you might notice unintended clicks, a cursor delay, or a dragging delay. If you set the pace too fast, you might find Press-to-Select hard to use.

## Customizing the TrackPoint

### Setting sensitivity

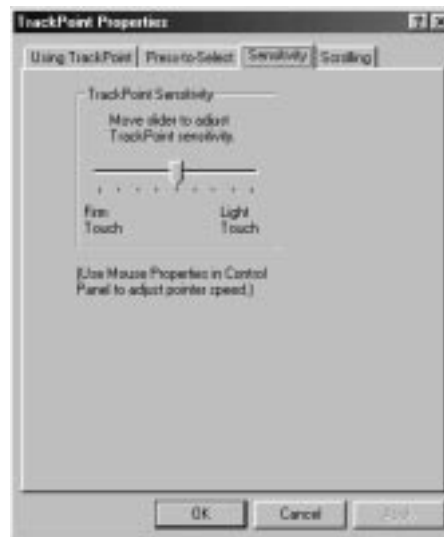

This function adjusts the force required for both cursor movement and Press-to-Select. To increase the force needed to move the cursor, and to activate Press-to-Select, move the slide toward **Firm Touch**. To decrease the force needed to move the cursor, and to activate Press-to-Select, move the slide toward **Light Touch**.

## Customizing the TrackPoint

### Setting scrolling or magnifying glass



By clicking the **Scrolling** tab, you can set the scrolling properties of your TrackPoint.

- **Choose Scrolling or Magnifying Glass Function**

Select one of the following radio buttons:

- **Scrolling**

This function enables you to navigate easily through long documents or large spreadsheets with the press of a button. To scroll, press the center click button and then use the TrackPoint instead of the scroll bars.

- **Magnifying Glass**

This function enables you to enlarge a movable area of your display. You can click objects “through” the magnifying glass. The right click button changes the size of the magnifying glass, and the left click button changes its magnifying power. You can press the center click button and then use the TrackPoint to move the magnified area.

- **Neither**

This function disables the scrolling and magnifying glass functions.

## Customizing the TrackPoint

- **Choose Scrolling Method**

Select one of the following radio buttons:

- **Press Center Button, then use TrackPoint**

This option enables you to hold down the center click button on the keyboard and then use the TrackPoint to control the scrolling or the magnifying glass. When you are not holding down the center button, the TrackPoint operates normally; that is, it controls the mouse cursor.

- **Use External Mouse**

This option sets an externally attached mouse to scroll (or move the magnifying glass) horizontally or vertically. The TrackPoint functions simply as a cursor.

- **Use TrackPoint**

This option sets the TrackPoint to scroll horizontally or vertically without your holding down the center button. Use an externally attached mouse as a cursor.

You can still use the TrackPoint to control the mouse cursor by pressing the center button.



The **Use External Mouse** and the **Use TrackPoint** radio buttons are enabled only if a mouse is attached and the TrackPoint is enabled. (→ “Enabling the TrackPoint” on page 63.)

- **Enable TrackPoint Scrolling Tips**

If you select this option, you can launch the TrackPoint Scrolling Tips function by pressing the center button three times. This function provides help for using the center button.

## Increasing memory

Increasing memory capacity is an effective way to make programs run faster. You can increase the amount of memory in your computer by installing a *dual inline memory module (DIMM)*, available as an option.

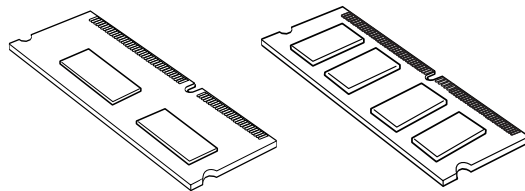

Different capacities of DIMM are available. You can install a DIMM directly in one of the memory slots on the bottom of the computer.

### **Attention**

Your computer supports the 100-MHz synchronous dynamic random access memory (SDRAM) card only. It does not support either the extended data output dynamic random access memory (EDO DRAM) card or the 66-MHz SDRAM. If you install a DIMM that is not supported by your computer, a 225 error code might appear when the system starts. You can purchase the appropriate memory option through your IBM reseller or IBM marketing representative.

## Increasing memory

### Installing the DIMM

To install the DIMM, do the following:

- 1** Power off the computer; then disconnect the AC Adapter and all cables from the computer.
- 2** Close the LCD, turn the computer over, and then remove the battery pack. (→ page 36.)
- 3** Loosen the screw on the memory slot cover; then remove the cover.

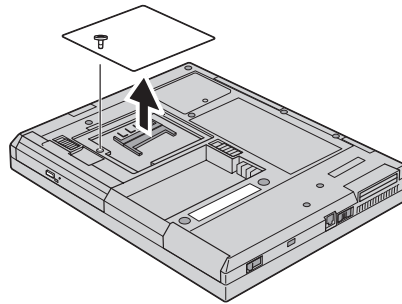

#### Attention

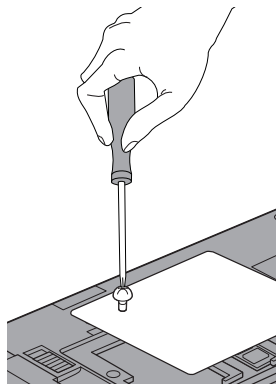

#### Handling a screwdriver

- Use a screwdriver that fits the screw.
- Use the screwdriver perpendicular to the head of the screw.

Handle the screwdriver properly; otherwise, you might damage the screw.



## Increasing memory

### Attention

To avoid damaging the DIMM, do not touch its contact edge.

- 4 Find the notch on the side of the DIMM.
- 5 With the notched end of the DIMM toward the socket, insert the DIMM, at an angle of about 25°, into the socket; then press it firmly **1**.
- 6 Pivot the DIMM until it snaps into place **2**.

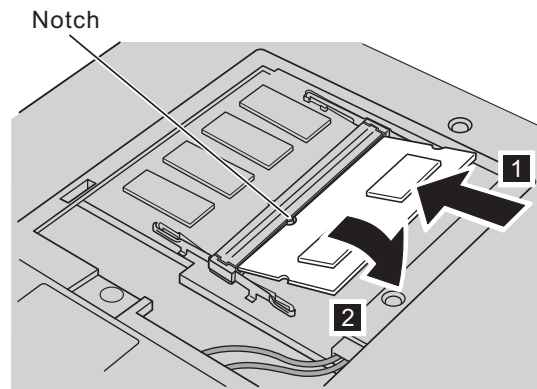

Side view

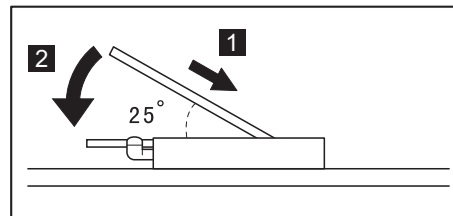

## Increasing memory



You can install two DIMMs. If you want to install a second DIMM, repeat steps 4 through 6.

Make sure to align the notches on the socket with those on the DIMM.

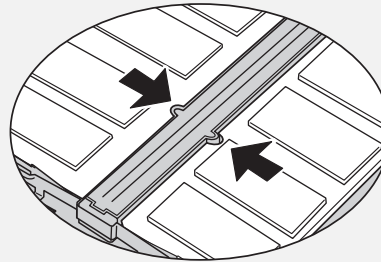

- 7** Replace the memory slot cover over the memory slot, aligning the back side of the cover first; then tighten the screw.
- 8** Replace the battery pack. (→ page 36.)
- 9** Turn the computer over again, and power it on.
- 10** Confirm that the new memory size appears at the upper left corner of the screen.

For example, if you install a 32-MB DIMM into your computer with 64-MB base memory, you should see the following. (See the next page for how to calculate the total memory size.)

```
097728 KB OK
```

You have finished installing the DIMM. Reconnect all cables.

## Increasing memory



1. If either of the following occurs, power off the computer and go to page 50 to reinstall the DIMM and do the memory test with Easy-Setup (→ page 155).

- If a 201 error code appears under the memory count.

```
048576 KB OK
201
```

- If the total memory size is not the same as the value you calculated.

2. If the 225 error code appears, the memory you are installing is not supported by your computer.
3. If you have changed the memory installed in the computer, you need to create a new hibernation file, as follows:
- a) Power off the computer.
  - b) Remove the DIMM you added.
  - c) Power on the computer, and disable hibernation mode.
  - d) Add the DIMM.
  - e) Enable hibernation mode.

To disable and enable hibernation mode →  
*Online User's Guide.*



### How to calculate total memory size

Calculate your total memory size in kilobytes (KB) by adding the DIMM memory size to the base memory size (64960 KB).

For example, if you installed a 32-MB DIMM into your computer with 64-MB base memory, you should have about 96 MB.

Your computer might display memory size in kilobytes. For example, 96 MB=97728 KB.

**Note:** 576 KB is reserved by the system.

## Increasing memory

### Removing the DIMM

- 1** Power off the computer and disconnect the AC Adapter and all cables from the computer.
- 2** Close the LCD, turn the computer over, and then remove the battery pack.
- 3** Loosen the screw and remove the memory slot cover.
- 4** Press out on the latches on both edges of the socket at the same time.

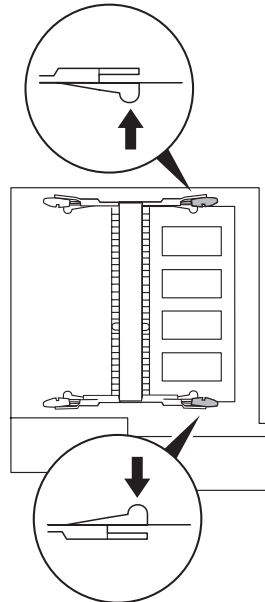

- 5** Remove the DIMM.  
Be sure to save the DIMM for future use.
- 6** Replace the memory slot cover; then tighten the screw.
- 7** Replace the battery pack.
- 8** Turn the computer over again; then connect the AC Adapter and all the cables you disconnected.

## Upgrading the hard disk drive

You can increase the storage capacity of your computer by replacing the original, built-in hard disk drive with an optional one. You can purchase the option from your IBM reseller or IBM marketing representative.



Replace the hard disk drive only if you upgrade it or have it repaired. **You should not replace it often.**



### Attention Handling a hard disk drive

- **Do not drop or apply any shock.**
- **Do not apply pressure to the cover.**
- **Do not touch the connector.**

The drive is very sensitive. Incorrect handling can cause damage and permanent loss of data on the hard disk. Before removing the hard disk drive, make a backup copy of all the information on the hard disk. Never remove the drive while the system is operating, in suspend mode, or in hibernation mode.

To replace the hard disk drive, do the following:

- 1** Power off the computer; then disconnect the AC Adapter and all cables from the computer, and turn the computer upside down.
- 2** Remove the battery pack. (→ page 36.)

## Upgrading the hard disk drive

- 3 Remove the coin screw by rotating it counterclockwise with a coin, as shown **1**; then remove the hard disk drive cover **2**.

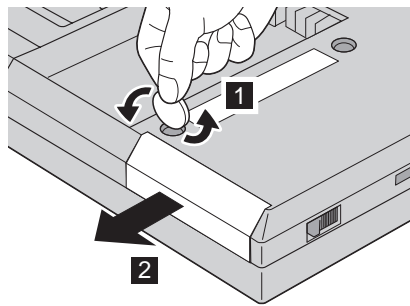

### CAUTION

Do not use your fingernails to open the hard disk drive cover. You might injure your fingernails. To open the drive cover, use a coin.

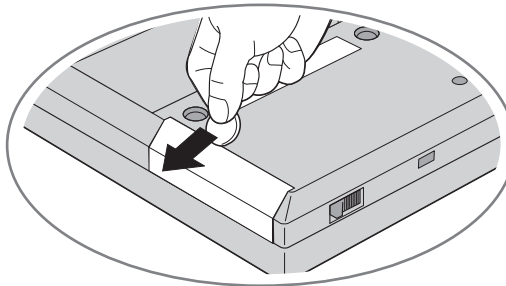

- 4 Pull the strap of the hard disk drive to remove the drive.

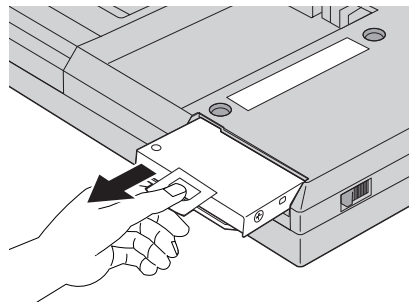

## Upgrading the hard disk drive

**5** Insert the new hard disk drive into the bay. Make sure you connect the drive firmly.



- Make sure the pins of the connector of the hard disk drive are not bent.
- Do not use force when inserting the hard disk drive into the bay. The connector is sensitive, and it might get damaged.
- If the hard disk drive that you will be installing has a spacer on it, remove the spacer, using something like a small screwdriver.

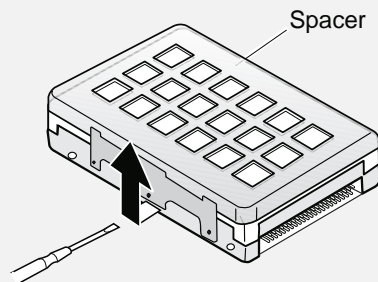

**6** Replace the hard disk drive cover, and reinstall the screw.

## Upgrading the hard disk drive



- You can replace the coin screw with a security screw to prevent the hard disk drive from being removed easily. For more information → “Using the security screw” on page 110.
- If you install the hard disk drive and the hard disk drive cover doesn't fit, remove the spacer for the hard disk drive cover by pressing the side of it, using the tip of a ball-point pen.

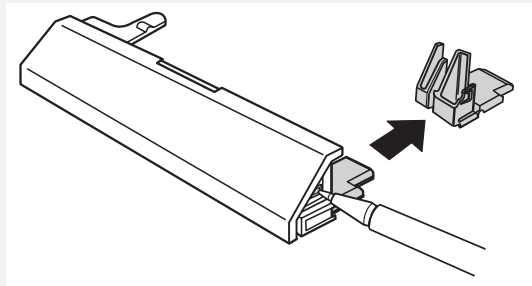

**7** Replace the battery pack. (→ page 36.)

**8** Turn the computer right-side up, and power it on.



## *Attaching an external mouse, keypad, or keyboard*

### **Attaching an external mouse, keypad, or keyboard**

This section explains how to attach an external mouse, an external numeric keypad, or an external keyboard to your computer.

#### **Attaching an external mouse or numeric keypad**

You can attach an external mouse or numeric keypad to the external-input-device connector (  ) on the rear of the computer.



**Mouse**

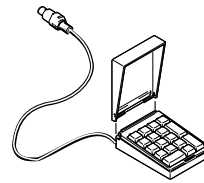

**Numeric keypad**

If you want to attach the mouse, attach it directly to the external-input-device connector as shown:

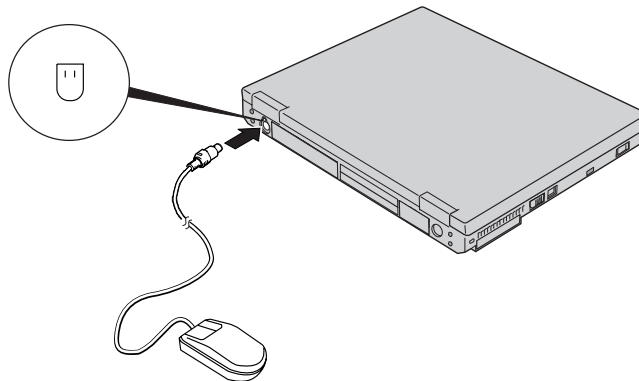

### Attaching an external mouse, keypad, or keyboard

If you want to use both the external numeric keypad and the mouse at the same time, first connect the keypad cable to the computer **1**; then connect the mouse cable **2** to the connector at the rear of the keypad.

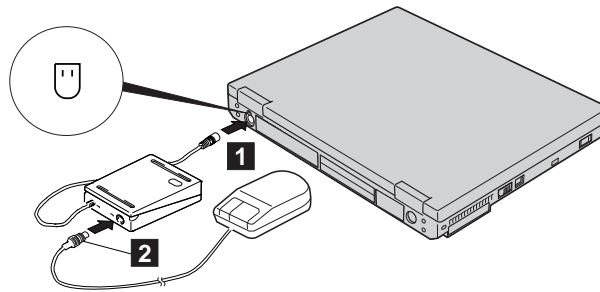

#### Attention

You can use both the IBM PS/2 Miniature Mouse and the TrackPoint as input devices. To connect a mouse other than an IBM PS/2 Miniature Mouse → “Enabling the TrackPoint” on page 63.



You can remove the keypad cover and use it as a stand for the keypad.

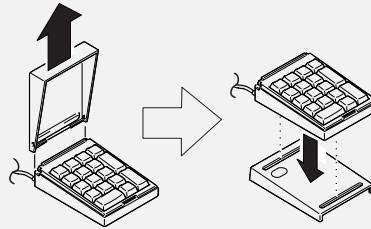

## *Attaching an external mouse, keypad, or keyboard*

### **Attaching an external keyboard and mouse**

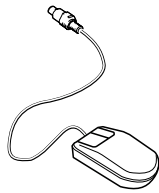

**Mouse**

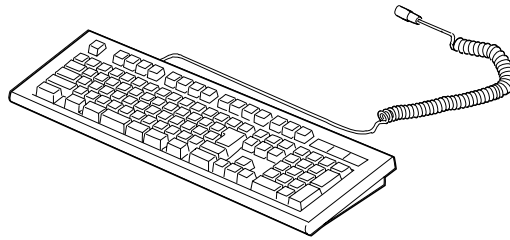

**External keyboard**

If you want to attach an external keyboard to your computer, do one of the following:

- Use the optional keyboard/mouse cable.
- Use an optional port replicator.

***The external keyboard will not work if it is connected directly to the computer's external-input-device connector.***

See the *Options by IBM Catalog*, supplied with your computer, for details about the options.

When the external keyboard is attached, the following keys are not available:

- Numeric keypad on the computer keyboard
- External numeric keypad

Instead, use the numeric keypad on the external keyboard.

## Attaching an external mouse, keypad, or keyboard

To attach the external keyboard, first power off the computer. Then attach the keyboard to the keyboard connector of the keyboard/mouse cable **1**, and attach the keyboard/mouse cable to the computer **2**.

You can attach a mouse to the mouse connector of the keyboard/mouse cable.

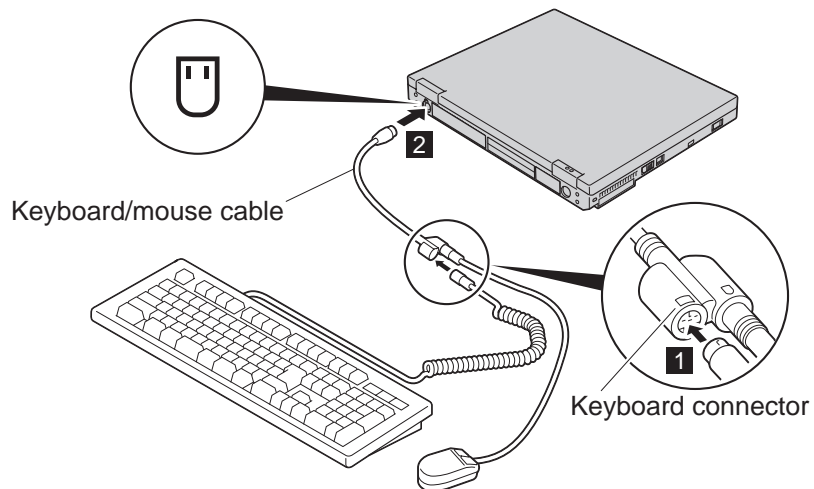

### Using the IBM ThinkPad Space Saver Keyboard

If you are using the IBM ThinkPad Space Saver Keyboard, **do not** install the device driver supplied with the keyboard. The device driver on the computer's utility diskette automatically enables or disables the TrackPoint when the power to the computer is turned on.

## *Attaching an external mouse, keypad, or keyboard*

### **Enabling the TrackPoint**

The TrackPoint is set to **Auto-Disable** as a default. With this setting, the TrackPoint is disabled automatically if a mouse is connected to the external-input-device connector and if any of the following is true:

- The system is starting.
- The system is resuming from suspend mode.
- Your computer is attached to the docking station.

If no external mouse is connected, the TrackPoint remains enabled.

The TrackPoint is designed to work simultaneously with a mouse that is compatible with the IBM PS/2 Miniature Mouse if the TrackPoint is set to **Enable**.

To enable the TrackPoint:

- 1** Start the ThinkPad Configuration program.  
See “ThinkPad Configuration program” on page 25.
- 2** Click the **TrackPoint** () button.
- 3** Click **Enable** from the dropdown menu.
- 4** Click **OK**.



If you are using a mouse connected to the serial connector or the USB connector, you should not use the TrackPoint at the same time. Click **Disable** rather than **Enable** or **Auto-Disable**.

## *Attaching an external monitor*

### **Attaching an external monitor**

This section provides information about using the computer LCD and an external monitor (CRT).



The LCD of your computer uses thin-film transistor (*TFT*) technology. The LCD displays output with XGA (1024 x 768 resolution) video mode and 16M colors.

If you are attaching an external monitor that supports a resolution higher than VGA mode, you can achieve a maximum video resolution of 1280 x 1024.

To attach an external monitor, do the following:

- 1** Power off the computer.
- 2** Connect the external monitor to the external-monitor connector () on the rear of the computer; then connect the monitor to an electrical outlet.
- 3** Power on the external monitor and the computer.
- 4** Start the ThinkPad Configuration program.
  - ➔ “ThinkPad Configuration program” on page 25.

## Attaching an external monitor

- 5** Choose the display output by clicking the **Both LCD and CRT Display** () button or the **CRT Display Only** () button (with Windows 98, at the *top left* of the screen; with Windows NT, a little to the *right of the top center* of the screen).

### Attention

- Do not change the display output location while a moving picture is being drawn—for example, playing a movie or a game. Stop the application before changing the display output location.
- If you use the **Both LCD and CRT Display** function, the external monitor must support the same resolution and the same refresh rate as your ThinkPad computer. If you are using an external monitor that does not support the resolution of the ThinkPad LCD (1024 x 768) and its refresh rate (60 Hz), do not use **Both LCD and CRT Display**.



You can also change the display output location by pressing **Fn+F7**.

- 6** Set your monitor type as follows.



For information on the color depths and resolutions supported → “Resolutions, color depths, and refresh rates” on page 66.

## Attaching an external monitor

- a) Click **Start**.
- b) Move the cursor to **Settings** and **Control Panel**, and then click **Control Panel**.
- c) Double-click **Display**.
- d) Select the **Settings** tab.
- e) Click **Advanced...**
- f) Click the **Monitor** tab.
- g) Click **Change...**

The "Update Device Driver Wizard" window appears. Follow the instructions on the screen to select your monitor type from the monitor list, and click a new resolution, color depth, and refresh rate.

**7** Restart the computer to make the changes effective.

### Attention

**Do not disconnect the external monitor while the computer is in suspend mode or hibernation mode. If no external monitor is attached when the computer resumes, the LCD remains blank and output is not displayed. This restriction does not depend on the resolution value.**

*Resolutions, color depths, and refresh rates:* The following tables show the resolutions, color depths, and refresh rates available with your computer or external monitor. Use these tables to set the display output (**LCD Only**, **CRT Display Only**, or **Both LCD and CRT Display**).



When installing an operating system, you must install the display driver supplied with the computer to use XGA mode.



## Attaching an external monitor

- Displaying output on the LCD or on both the LCD and the external monitor (**LCD Only** or **Both LCD and CRT Display**)

Resolution	Supported color depth
640 x 480 (VGA)	256, 64K, and 16M
800 x 600 (SVGA)	256, 64K, and 16M
1024 x 768 (XGA)	256, 64K, and 16M
1280 x 1024 (SXGA)	256 (virtual screen)



You can use the *virtual screen* function to display a part of the high-resolution screen image produced by your computer. You can see other parts by moving the screen with the TrackPoint or other pointing device.

- Displaying output only on the external monitor (**CRT Display Only**)

Resolution	Supported color depth	Refresh rate
640 x 480 (VGA)	256, 64K, and 16M	60 Hz, 75 Hz, or 85 Hz
800 x 600 (SVGA)	256, 64K, and 16M	60 Hz, 75 Hz, or 85 Hz
1024 x 768 (XGA)	256, 64K, and 16M	60 Hz, 70 Hz, 75 Hz, or 85 Hz
1280 x 1024 (SXGA)	256	60 Hz



If you are using an old external monitor, the resolution and refresh rate might be limited.

## Attaching an external monitor

### Attaching a television to your computer

Though there is a video-out icon on your computer, your computer might not support the video-out function. This section is applicable only if your computer has a video-out connector and supports the function. For considerations on using a television → page 74.

You can attach a television (NTSC or PAL) to your computer and display the computer output on it. To display the computer output on television, do the following:

- 1** Power off the computer and television.
- 2** Connect the video connector cable to the video-out connector (  ); then connect the other required cable to the television.

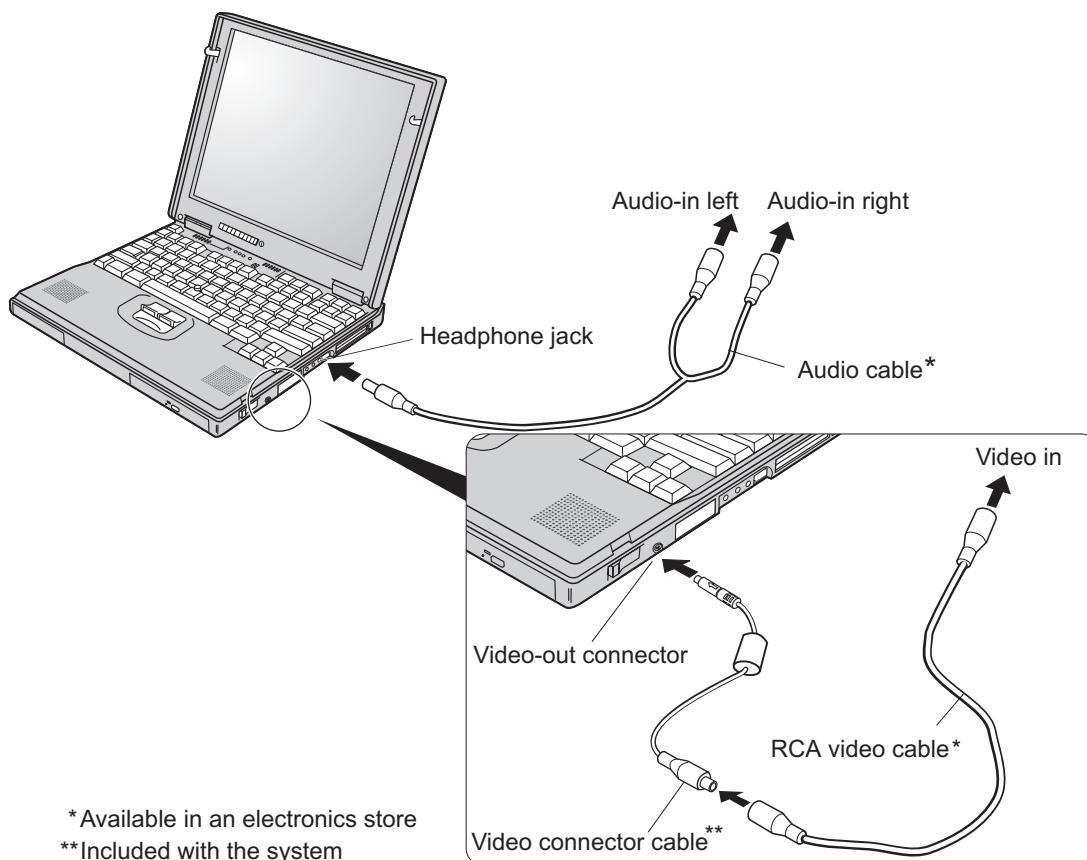

\* Available in an electronics store

\*\* Included with the system

## *Attaching an external monitor*

- 3** Connect the audio cable to the headphone jack on the computer; then connect the cable to the audio-input connectors of your video equipment.

If your video equipment has only one audio-input connector, use the left-audio connector of the audio cable.

- 4** Enable the video-out connector (TV-out), as follows:

- a) Click **Start**.
- b) Move the cursor to **Settings** and **Control Panel**; then click **Control Panel**.
- c) Double-click **Display**.
- d) Select the **Settings** tab, and click **Advanced....**
- e) On the **NeoMagic** tab, select the **TV** check box.
- f) Click the slider to select a TV resolution—either 640 x 480 or 800 x 600.
- g) Click **Advanced Settings**.
- h) Select the **TV Options** tab.
- i) Select either NTSC or PAL from the “TV Output Standards” field.
- j) Select either S-Video or Composite from the “Output Selection” field.



- You can reduce flicker on the screen by selecting the **Flicker Reduction** check box.
- You can change the **contrast** and the **brightness** from the “Output Options” field.

- k) Click **OK** to close the window.
- l) Click **OK** to apply the changes.
- m) Click **OK**.



**For the Windows NT user:** Skip step 4d and 4m.

## Attaching an external monitor

### Considerations for using the TV-out function

There are a few things to consider when you use the TV-out function.

- The following table shows the display modes that you can choose when you use the television:

Resolution	Color depth	Display mode for television
640 x 480	256, 64K	The whole image is shown on the screen.
800 x 600		
1024 x 768	256, 64K	The image is shown as a virtual screen. (On the LCD the whole image is shown on the screen.)
1280 x 1024	256	The image is shown as a virtual screen.



- You cannot use 16M colors on the television. You cannot display the output with the television alone.
  - You can use the television only with the LCD, not with an external monitor (CRT).
- 
- If you use DOS full screen (VGA mode) on television, the screen will be blank.
  - If you play a video clip (AVI or MPEG file) and move the cursor on the window, the cursor disappears under the image.
  - You cannot use the **Fn + F7** (display switching) function when you are in the dual display mode or when you are displaying the image on the television and the LCD simultaneously.
  - To use this function with the TV as the secondary display or the simultaneous display, you need to enable the television settings every time you start your computer.
  - Note the following when the TV is the secondary display or the simultaneous display: Because of the television aspect ratio (screen shape), the edge of the image will be cut off even when you set the smallest resolution.

## Using the dual display function

Windows 98 supports a function named *Multiple Display Support*, and your computer supports a function named *dual display* in the Windows 98 environment. This function enables the Windows 98 desktop to display output on the LCD-CRT display pair or (if your computer has a video-out connector) the LCD-TV display pair. You can display different desktop images on each monitor.

For information on connecting a television to your computer →  
page 68.



- When you enable the dual display function on a television, you need to first connect a CRT. After enabling the dual display function on the CRT, change the output location to the television.
- During the operation, you need to restart your computer. Before starting to enable the function, save your data and close your applications.

To enable the dual display, do as follows:

- 1** Attach the computer to an external monitor (CRT) or a television.
- 2** Click **Start**.
- 3** Move the cursor to **Settings** and **Control Panel**; then click **Control Panel**.
- 4** Double-click **Display**.
- 5** Select the **Settings** tab.
- 6** Click **Advanced...**
- 7** Select the **NeoMagic** tab.
- 8** Select the **Set Dual Display** check box; then click **OK**.

The “System settings change” window appears, prompting you to restart the application.

## Attaching an external monitor

- 9** Click **Yes** to restart the computer.
  - 10** Open the “Display Properties” window again by double-clicking on **Display** in the Control Panel.
  - 11** Select the **Settings** tab.  
An image of two monitors assigned with numbers appears.
  - 12** Click the **Monitor-2** icon (for the secondary display, either the CRT or the TV).
  - 13** Click **Yes** to enable monitor 2.
  - 14** Click the **Monitor-1** icon (for the primary display, the LCD).
  - 15** Select the color depth and the resolution of the primary display.
  - 16** Click the **Monitor-2** icon (for the secondary display, the CRT or TV).
  - 17** Select the color depth and the resolution of the secondary display.
  - 18** Set the relative position of the each monitor by dragging its icon.
-  You can set the monitors in any relative position, but their icons must touch each other.
- 19** Click **OK** to apply the changes.

## *Attaching an external monitor*

### *Disabling the dual display*

- 1** Click **Start**.
- 2** Move the cursor to **Settings** and **Control Panel**; then click **Control Panel**.
- 3** Double-click **Display**.
- 4** Select the **Settings** tab.
- 5** Click the **Monitor-2** icon (for the secondary display, the CRT or TV).
- 6** Clear the **Extend my Windows desktop onto this monitor** check box.

The secondary display (monitor 2) is disabled.

If you do not want to disable the dual display function entirely (because you might wish to use it later in this session, for example), just click **OK** and skip the remaining steps. Then you can enable the secondary display by clicking the display icon.

To disable the dual display function entirely (for better performance and to remove some limitations), continue the procedure as follows. (You can always reenable the function by following the procedure from step 12 on page 72.)

- 7** Click **Advanced...**
- 8** Select the **NeoMagic** tab.
- 9** Clear the **Set Dual Display** check box.
- 10** Click **OK**.

The "System settings change" window appears to prompt you to restart the application.

- 11** Click **Yes** to restart the computer.

## ***Attaching an external monitor***

### ***Considerations for using a dual display function***

- The primary display is always the LCD of your computer, and the secondary display is either a CRT or a television.
- When you enable the dual display function on a television, you need to first connect a CRT. After enabling the dual display function on the CRT, change the output location to the television.
- You can select up to 64K colors for your secondary display, either the CRT or the television.
- You can select a resolution up to 1024 x 768 for your secondary display.
- If you set the CRT as your secondary display and you want to show DOS full screen, both the primary display (LCD) and the secondary display (CRT) become DOS full-screen modes.
- If you play a video clip (AVI or MPEG file) while using the dual display function, the image is in overlay mode only on the LCD.
- If you play a video clip (AVI or MPEG file) and move the cursor on the window, the cursor disappears under the image.
- When an application using the DirectDraw or the Direct3D is played in full-screen mode, it is shown only on the primary display (LCD).
- You cannot use the **Fn + F7** (display switching) function when you are in the dual display mode or when you are displaying the image on the television simultaneously with the LCD.



## Installing a PC Card

This section describes how to install a PC Card. For information on how to use the PC Card software → *Online User's Guide*.

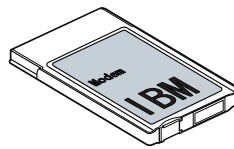

### Attention

Do not insert a PC Card while the computer is in suspend mode or hibernation mode. Otherwise, the system might hang when resuming.

Your computer has two PC Card slots (upper slot and lower slot) and supports the following types of cards:

- PC Card (Type I, Type II, and Type III)
- CardBus Card
- Zoomed Video (ZV)

**1** Find the notched edge **1** of the PC Card as shown.

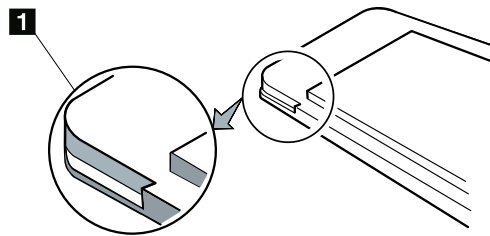

## Installing a PC Card

**2** Insert the PC Card into the slot appropriate for your PC Card type.



- If you are using a Type I or Type II PC Card, insert it into either the upper slot or the lower slot.
- If you are using a Type III PC Card, insert the card into the lower slot.
- Some Compact Smart Cards are too thick to be inserted into the upper PC Card slot of your computer. Insert such a card into the lower slot.

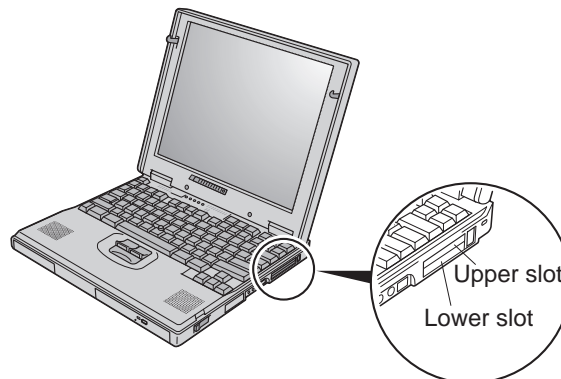

**3** Press the PC Card firmly into the connector.



- **For Windows 98:**  
If you have not installed the PC Card driver, Windows 98 starts to install it.
- **For Windows NT:**  
Your computer has PC Card support software called CardWizard. You can use the PC Card as soon as you insert the card into the computer. The "SystemSoft CardWizard" window appears and informs you about the new card.

## Removing the PC Card

### Attention

Do not remove a PC Card while the computer is in suspend mode or hibernation mode. Otherwise, the system might hang when resuming.

Before removing a storage PC Card, such as a hard disk PC Card, a Flash memory PC Card, or a SRAM PC Card, from the PC Card slot, **you must stop** the PC Card. Otherwise, data on the PC Card might be corrupted or lost.

- 1** Stop the card by selecting **Stop** from the “Actions” menu.



The **Stop** option appears in gray when you are in CardSoft mode or when the card is already stopped.

- 2** Press the PC Card eject button to pop out the button. Then press it again until the PC Card pops out.
- 3** Remove the PC Card and store it safely for future use.

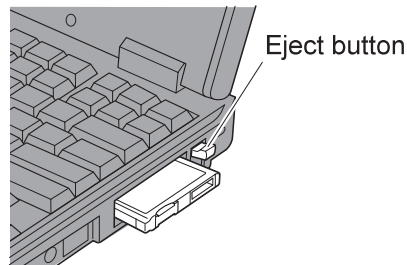

For more information for using a PC Card → *Online User's Guide*.

## Using a docking station

# Using a docking station

You can extend the capabilities of your computer by attaching it first to the SelectaBase 600 port replicator and a docking station.



The port replicator, available as an option, is a convenient way to attach several input-output devices and an external monitor. Of course, you can also attach these devices directly to your computer.

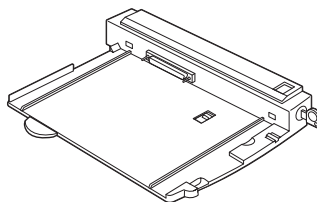

SelectaBase 600  
(port replicator)

Then you can attach (dock) the computer–port replicator combination to one of the following docking stations:

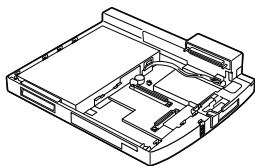

SelectaDock I

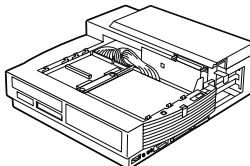

SelectaDock II

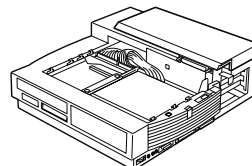

SelectaDock III

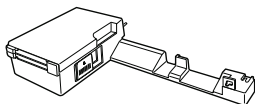

PC Card Enabler

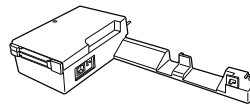

PC Card Enabler with Advanced EtherJet Feature

You can dock your computer to a docking station under the following conditions:

- With your computer powered off (*cold docking*)
- With your computer in suspend mode (*warm docking*)
- With your computer operating (*hot docking*)

## Using a docking station



- Depending on the hardware configuration or the operating system, warm docking or hot docking might not be supported. Refer to the user's guide shipped with these docking stations or a port replicator for instructions on how to dock your computer to a docking station.
- After you dock the SelectaDock I docking station with the SelectaBase 600 port replicator, you might not be able to read the status indicator or access the UltralimBay easily.
- In the Windows 95, Windows NT, Windows 3.1, or DOS environment, you need to install the PC Card support software *after* docking your computer to the docking station. If you have already installed the PC Card support software, uninstall it and then reinstall it after you dock your computer to the docking station.

## Cold docking

You should dock with both your computer and your docking station powered off in the following conditions:

- If it is the first time you are docking your computer to the docking station.

**Or:**

- If you have changed the device configuration of your docking station, such as when you have installed or removed a device. Cold docking resets the docking station's device status recorded on your computer. Thereafter, you can dock your computer with the docking station at any time.

## Using a docking station

To cold-dock your computer, do the following:

**1** Install new devices in the docking station.

**2** Connect the power cord or the AC Adapter.

If you use a SelectaDock I or SelectaDock II docking station, connect the power cord to the docking station and the AC Adapter to a SelectaBase 600 port replicator.

If you use a SelectaDock III docking station, connect the power cord to the docking station.

If you use a PC Card Enabler or a PC Card Enabler with Advanced EtherJet Feature, connect the AC Adapter to the SelectaBase 600 port replicator.

**3** Dock your computer to the docking station.

See the user's guide shipped with the docking station for how to dock your computer to it. If you use the SelectaDock I, SelectaDock II, or SelectaDock III docking station, the symbol

 appears on the docking station status indicator, showing that the computer is properly docked.

**4** Power on the computer.

Windows 98 or Windows 95 begins to check the status of the docking station and restarts a couple of times. Follow the instructions that appear on the screen.

During this operation, Windows 98 or Windows 95 creates a configuration profile for the docking station with the name *Dock X*.

### Attention

If you are prompted to install the display driver, exit the window by clicking **Cancel**. You need to restart the computer and customize the display setting after you create a configuration profile.



- X can be any number from 1 to 3.
- The message "Version Conflict" might appear on the screen. Answer **Yes** to the prompt "Do you want to keep this file?"

## Using a docking station

**5** In Windows 98 or Windows 95, select **My Computer**, **Control Panel**, **System**, and then the **Hardware Profile** tab.

**6** Make sure the new profile, Dock X, is created. Also, select the **Device Manager** tab and make sure that the new devices are displayed in the device list.

If Dock X is not created, repeat from step 1.

If the symbol “!” or “x” appears next to the device symbol, a resource conflict might have occurred. To resolve the problem

➔ *Online User's Guide.*

After the new hardware profile Dock X is created, you can dock or undock your computer while power is on.

## Cold undocking

To undock your computer from the docking station when the computer is powered off, do the following:

- 1** Power off your computer.
- 2** Turn the security key to the eject position to eject the computer.
- 3** Lift the computer out.

You have completed the cold undocking.

## Hot or warm docking

In the boot process after cold docking, the operating system tries to set a configuration including the devices installed in the docking station. After the configuration has been set up, you can hot or warm dock your computer to the docking station. The docking station devices immediately become available to your computer.

## Hot or warm undocking



If your computer does not enter suspend mode while it is docked in the docking station, do the following:

1. Start the ThinkPad Configuration program.
2. Click the **Power Management** () button.
3. Click the **Suspend/Resume Options** tab.
4. Select the **Suspend/hibernate while docked** check box.

Your computer can now enter suspend mode while docked.

To undock your computer from the docking station when the computer is operating (*hot undocking*) or when the computer is in suspend mode (*warm undocking*), do the following:

- 1 Select **Start** in Windows 98 or Windows 95, and then **Eject PC**. The LCD screen on your computer powers off and on.

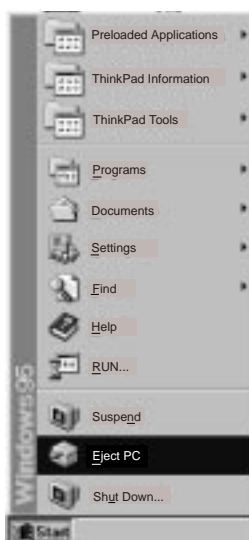



## Using a docking station

**Or:**

Turn the security key of the docking station to the eject position and release the key.

An eject request is made to the operating system. It might take some time for this eject operation to end.



To see if the eject operation is complete, click **Start** again and see if the **Eject PC** icon still appears. If the icon still appears, wait until it disappears.

If the eject request does not disappear → “Docking station or port replicator problems” on page 143.

- 2 When you hear a beep, turn the security key to the rear again. Now you can eject your computer from the docking station.



If the operating system rejects the eject request, a message appears on the screen. If this happens, try *cold undocking*.

## Presetting a device to avoid a resource conflict

After you install devices in the docking station, the Windows 98 or Windows 95 plug-and-play function enables you to use the devices immediately after you power on your system. If you cannot use them, a system resource conflict might have occurred. Do the following to resolve the conflict:

**For a PCI adapter or an internal SCSI device:**

- 1 Start the ThinkPad Configuration program and click the **Docking Station** () button.
- 2 Assign at least one IRQ value. The default setting is IRQ 9.

## Using a docking station

### For an ISA adapter card:

- 1 Open Windows 98 or Windows 95 Device Manager, and check the resources available for the new card.
- 2 Disconnect the AC Adapter from the SelectaBase 600 port replicator.
- 3 Set the jumper or the DIP switches on the adapter card.

### For an IDE device such as a hard disk drive or a CD-ROM drive:



Before you do the following steps, read "Enabling the IDE drive on the docking station."

- 1 Start the ThinkPad Configuration program, and click the **Docking Station** () button.
- 2 Click the **IDE Device** tab.
- 3 Select **Enable** in the **IDE device in the Docking Station** list box (if you haven't already), and restart the computer.
- 4 Click **Device Manager** and check whether there is a resource conflict between the new IDE device and the other devices in the computer. If there is a resource conflict, see the *Online User's Guide*.

## Enabling the IDE drive on the docking station

If you have installed an IDE device (such as a hard disk drive or a CD-ROM drive) in the docking station, you must change the setting on your computer to enable the device. By default, your computer uses the primary IDE channel for the primary hard disk drive (primary-master) and the secondary IDE channel for a device in the UltralimBay (secondary-master). You cannot use the IDE device in the docking station in this default **2-channel default IDE mode**.

## Using a docking station

To enable an IDE device in the docking station, you must change the default setting to either of the following:

- **3-channel IDE mode.** In this mode, you can still use the hot and warm swap functions for a device in the UltraslimBay. An additional IRQ for the third IDE channel is required.
- **2-channel IDE mode.** In this mode, you do not have to assign an extra IRQ. However, you cannot use hot and warm swap functions for a device in the UltraslimBay.



If you change the IDE channel configuration, the drive letter assignment might be changed.

### Setting to 3-Channel IDE mode

- 1** Open the **ThinkPad Configuration** program.
- 2** Click the **Docking Station** () button.  
The “Docking station” window appears.
- 3** Click **Device Manager...**  
The “System Properties” window appears.
- 4** Click **Computer**; then click **Properties**.
- 5** Determine an available IRQ value other than IRQ 11 or 15 (IRQ 9 is recommended) by checking the current setting under the **View Resources** tab. If there is no available IRQ value, you can make space for it by removing a device that is not being used. To do this, select the **Device Manager** tab; click the device you are removing; and then click the **Remove** button.
- 6** Click **OK** to close the “System Properties” window.
- 7** Return to the “Docking station” window; then click on the **IRQ Holder for PCI Steering** tab.
- 8** Change the IRQ value in **1st IRQ** to the available value you determined in step 5.

## *Using a docking station*

- 9** Click the **IDE Device** tab.
- 10** In the **IDE device in the docking station** list box, select **Enable**.
- 11** In the **IDE Channel** list box, select **Third**.
- 12** Click **OK** to close the “Docking station” window.
- 13** Restart the system by clicking **OK** in the warning dialog box.

## *Setting to 2-Channel IDE mode*

- 1** Open the **ThinkPad Configuration** program.
- 2** Click the **Docking Station** () button.  
The “Docking station” window appears.
- 3** Click **Device Manager...**  
The “System Properties” window appears.
- 4** Click **Computer**; then click **Properties**.
- 5** Determine an available IRQ value other than IRQ 11 by checking the current setting under the **View Resources** tab. If there is no available IRQ value, you can make space for it by removing a device that is not being used. To do this, select the **Device Manager** tab; click the device you are removing; and then click the **Remove** button.
- 6** Click **OK** to close the “System Properties” window.
- 7** Return to the “Docking station” window; then click the **IRQ Holder for PCI Steering** tab.
- 8** Change the IRQ value in **1st IRQ** to the available value you determined in step 5.

## Using a docking station

- 9 Click the **IDE Device** tab.
- 10 Select **Enable** in the **UltraBay IDE device in the docking station** list box.

The third IDE is automatically selected.



Though the name of the list box uses the term *UltraBay*, it refers to your *UltraslimBay*.

- 11 Select **Second** in the **IDE Channel** list box.
- 12 Click **Disable Devices** in the warning dialog box.
- 13 Click **OK** to close the dialog box.
- 14 Restart the system by clicking **OK** in the warning dialog box.

The following table shows how the devices are related to the IRQ values:

Device	2-channel IDE default mode	3-channel IDE mode	2-channel IDE mode
Hard disk drive	IRQ 14, P-M	IRQ 14, P-M	IRQ 14, P-M
UltraslimBay	IRQ 15, S-M	IRQ 15, S-M	IRQ 14, P-S
Docking station	Disabled	IRQ 11, T-M and T-S	IRQ 15, S-M and S-S

### Legend:

1. P-M: Primary-master
2. P-S: Primary-slave
3. S-M: Secondary-master
4. S-S: Secondary-slave
5. T-M: Third-master
6. T-S: Third-slave

## Replacing an UltralimBay device

# Replacing an UltralimBay device

You can install one of the storage devices in the UltralimBay.

The following procedure describes how to replace the DVD-ROM drive with the diskette drive; follow the same procedure to install the other storage devices in the UltralimBay.

- 1** Power off the computer, and remove the AC Adapter and cables; then turn the computer upside down.
- 2** Push the UltralimBay device lock to the unlocked position **1**; then remove the DVD-ROM drive **2**.

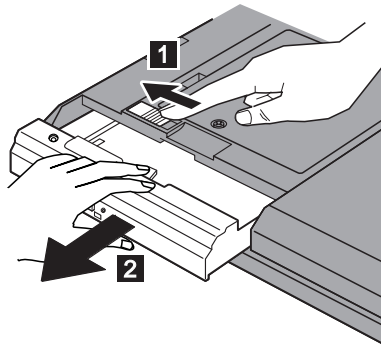

- 3** Insert the diskette drive.

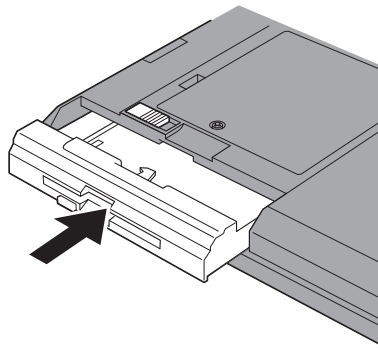

## Warm-swapping a device in the UltralimBay

*Warm swap* means to remove or reconnect a device when the computer is in suspend mode. Warm swap is enabled as a default on your computer.

To check whether warm swap is enabled, do as follows:

- 1** Start the ThinkPad Configuration program.  
→ “ThinkPad Configuration program” on page 25.
- 2** Click **UltraBay** (  ).
- 3** Make sure that the **Warm swap devices** check box is selected.  
If the check box is clear, select it and restart your computer to make the change effective.

To warm-swap a device in the UltralimBay, enter the computer into suspend mode; then swap the device.

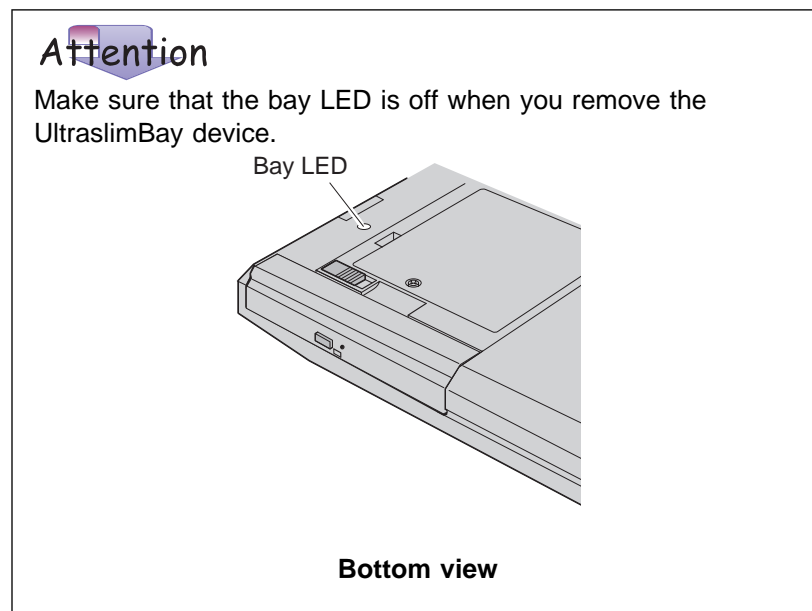

## Replacing an UltralimBay device



1. If you install a secondary hard disk drive into the UltralimBay, you *cannot* warm-swap it. Power off your computer; then swap the device.
2. The diskette drive in the UltralimBay always takes precedence over the external diskette drive. For example, in suspend mode, if you install a diskette drive in the UltralimBay and attach a diskette drive externally, the computer recognizes the diskette drive in the UltralimBay after resuming.
3. If the external diskette drive is attached, you cannot install another diskette drive in the UltralimBay.



## *Attaching the diskette drive externally*

### **Attaching the diskette drive externally**

You can connect the diskette drive to the external diskette-drive connector and use it as an external diskette drive.



You don't need to reboot your computer to recognize the diskette drive every time you reconnect or swap the diskette drive in your computer. You enter your computer into suspend mode and reconnect or swap the diskette drive. Your computer recognizes the diskette drive after resuming.

To attach the diskette drive externally, do the following:

- 1** Enter your computer into suspend mode.
- 2** Insert the diskette drive in the external diskette drive enclosure, and connect it firmly.

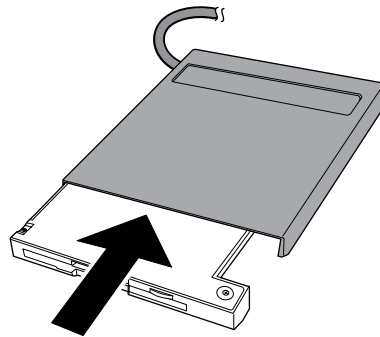

### Attaching the diskette drive externally

- 3 Connect the cable to the external diskette-drive connector.

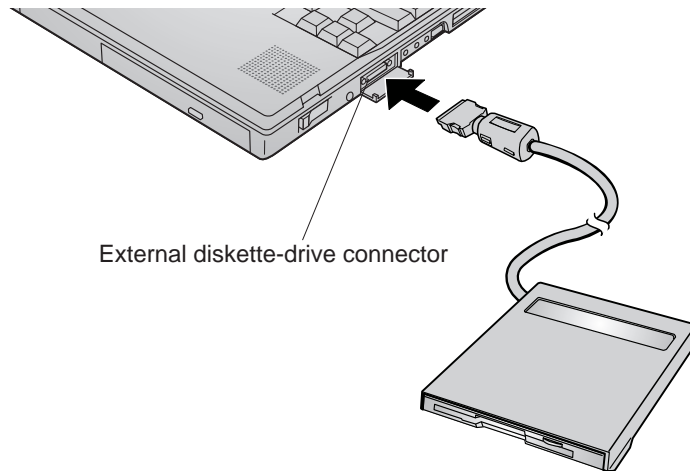

- 4 Wake the computer up from suspend mode.

### Removing the diskette drive from the enclosure

#### Attention

The enclosure is designed only for the diskette drive. Do not insert any other drive into it.

The diskette drive enclosure has a lock on the bottom. To remove the diskette drive from the enclosure, hold the lock in the unlocked position and remove the drive.

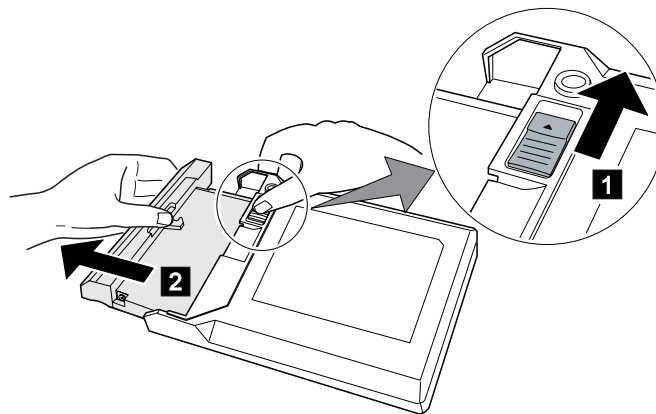

Bottom view

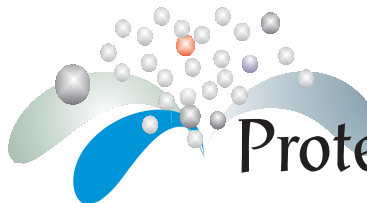

# Chapter 3

## Protecting your computer

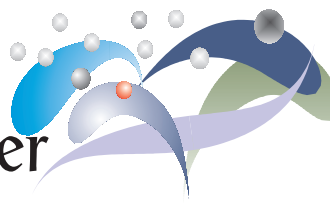

This chapter provides information about how to protect your computer from theft or unauthorized use. It also describes how to display your personal information, such as your name or address, on the password prompt screen.

Using passwords . . . . .	94
Entering a password . . . . .	96
Setting a password . . . . .	96
Changing or removing a password . . . . .	99
For a power-on password or a hard-disk-drive password . . . . .	99
For a supervisor password . . . . .	101
Removing a power-on password with supervisor authority . . . . .	103
Using the Personalization Editor . . . . .	105
Entering your personal data . . . . .	105
Deleting the personalization window . . . . .	108
Using locks . . . . .	109
Using the security screw . . . . .	110

## Using passwords

The password-setting feature helps to prevent your computer from being used by others. After you have set a password, a prompt appears on the screen each time you power on the computer. You must enter your password at the prompt. You cannot use the computer unless you type the correct password.

You can set the following passwords on your computer:

- **Power-on password**  
Set the power-on password to protect your computer from being used by another person. The power-on password is required both when the computer starts up and when it resumes from suspend mode.
- **Hard-disk-drive password**  
The hard-disk-drive password provides an extra measure of security. Even if you set a power-on password, another user can remove the hard disk drive from your computer and put it in a different computer to access your data. If you set a hard-disk-drive password, however, another person cannot access the data on your hard disk without knowing the password. A hard-disk-drive password provides the following security features:
  - You need to type the hard-disk-drive password at startup.
  - If the hard disk drive is moved to another computer, the hard-disk-drive password must be typed at startup. Therefore, unauthorized users cannot access your hard disk even if the drive is removed from the computer.
  - If you have not set a supervisor password, the hard-disk-drive password is required when the computer resumes from suspend mode.
  - If you select the **Prompt for password when computer goes off standby** check box in the “Power Management Properties” window, you are required to use the Windows 98 logon password to resume from suspend mode.

- **Supervisor password**

The supervisor password is a tool provided to enable the system administrator to control many ThinkPad computers. The supervisor password is set by the system administrator and is not required for users. You can start your computer without providing the supervisor password. The supervisor password is required only to access Easy-Setup. It provides the following security features:

- Only a system administrator can access Easy-Setup. If a supervisor password is set, a password prompt appears if you try to start Easy-Setup.
- The system administrator can use the supervisor password to access the computer even if you have set a power-on password. The supervisor password overrides the power-on password.
- If both the supervisor password and the power-on password are set, only the supervisor password enables you to access the following items:
  - Changing the boot sequence
  - Changing or deleting the power-on password
  - Changing or deleting the supervisor password
  - Enabling the Wake-on LAN feature
- The supervisor password has priority over the hard-disk-drive password. The supervisor password protects the hard disk by preventing unauthorized users from accessing data on the hard disk.
- The system administrator can set the same supervisor password on many ThinkPad computers to make administration easier.

- **Other passwords**

Some Microsoft operating systems provide special Windows passwords. For information on how to set, change, and use these passwords, refer to the user's guide for the operating system you are using.

## Using Passwords

### Entering a password

After you have set a password, a password prompt appears at the top left corner of the screen. This prompt appears each time you power on your computer or when your computer returns from suspend mode to normal operation.

However, a password prompt is not displayed if the computer returns to normal operation because of a preset timer or an incoming call on the modem. In this case, you will have to display it by pressing a key or moving the pointing device.

To enter a password, do the following:

**1** Type your password.

The • symbol appears each time you press a key. Don't hold down a key too long, because the same character will be entered continuously.

**2** Press the **Enter** key.

An **OK** appears if you enter the correct password, and an **X** appears if you enter the wrong password. If you fail to enter the correct password in three tries, you must power off the computer, wait 5 seconds, and then power it on again and retry.

### Setting a password

To set a password, do the following:

**1** Start Easy-Setup.

- a) Press and hold **F1**; then power on the computer.
- b) Hold **F1** until the "Easy-Setup" menu appears.

**2** Click **Password** in the "Easy-Setup" menu. For more information on the "Password" submenu → "Easy-Setup" on page 16.

**3** Click the type of password you want to set: **Power-On**, **HDD**, or **Supervisor**.

**4** Type your password.

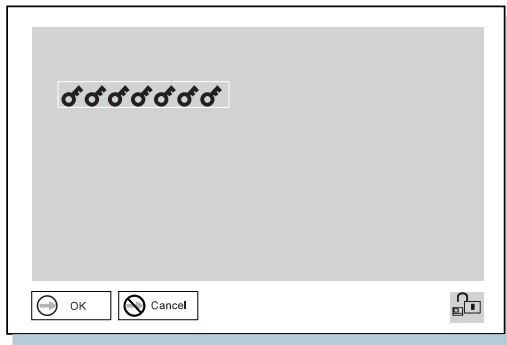

You can type a maximum of seven random characters, using a combination of letters (A to Z) and numbers (0 to 9). The uppercase and lowercase forms of a letter (for example, A and a) are treated as the same character. Characters that can be typed only by use of the **Shift** key (for example, !, \$, and %) are not acceptable.

If you type a wrong character, use the **Backspace** key to erase it, and then type the correct one.

**5** Press **Enter**. A password confirmation window appears:

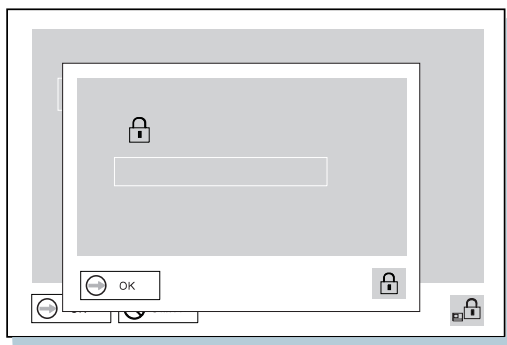

## Using Passwords

- 6 Type your password again to verify it; then press **Enter** again.



If you are setting the hard-disk-drive password or the supervisor password, the following window appears, reminding you to write down the password and keep it in a safe place:

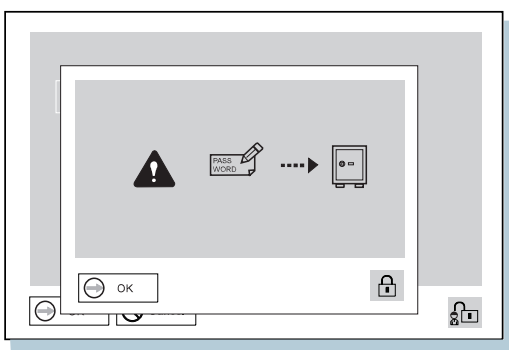

Your password is set.



### **Do not forget your password**

If you forget your hard-disk-drive password or supervisor password, **you cannot reset your password or recover data from the hard disk**. You have to take your computer to an IBM reseller or an IBM marketing representative to have the hard disk or the system board replaced. Proof of purchase is required, and an additional charge might be required for the service. Neither an IBM reseller nor IBM marketing representative can make the old hard disk drive usable.



## Changing or removing a password

This security feature prevents someone from removing a password and using your computer. To change or remove a password, do the following:

*For a power-on password or a hard-disk-drive password*

- 1 Power off the computer and wait at least 5 seconds; then power on the computer.

The password prompt appears.

- 2 Type your current password.

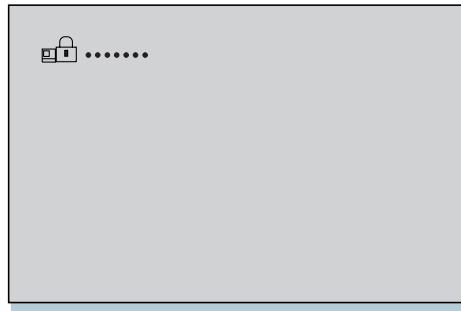

- 3 Press the **Spacebar**.

To change the password, go to step 4.

To remove the password, press **Enter**.

The following window appears, and the system starts:

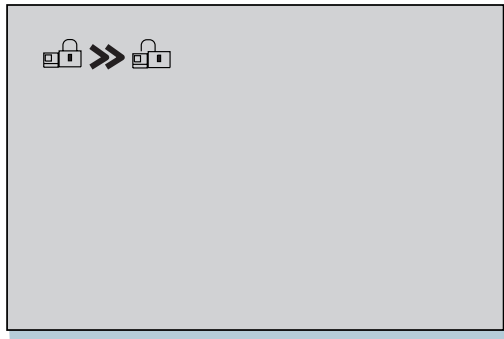

You have removed your password. Skip the remaining steps.

## Using Passwords

- 4 To change the password, type the new password; then press the **Spacebar**.

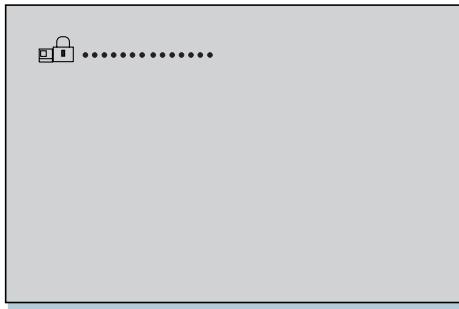

- 5 Type the new password again to verify it; then press **Enter**.

The following window appears, and the system starts:



Write down the password and keep it in a safe place.

You have changed your password.

*For a supervisor password*

**1** Start Easy-Setup.

- a) Press and hold **F1**; then power on the computer.
- b) Hold **F1** until the password prompt appears.

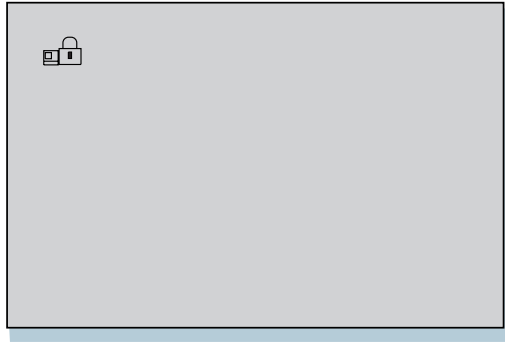

**2** Enter the supervisor password.

The “Easy-Setup” menu appears.

**3** Select **Password** on the menu.

**4** Select **Supervisor**.

To change the password, go to step 8.

**5** To remove the password, enter the current password and press the **Spacebar**.

**6** Press **Enter** twice.

**7** Click **Exit**; then click **Restart**.

The supervisor password has been removed. Your computer restarts. Skip the remaining steps.

## Using Passwords

**8** Enter the current password and press the **Spacebar**.

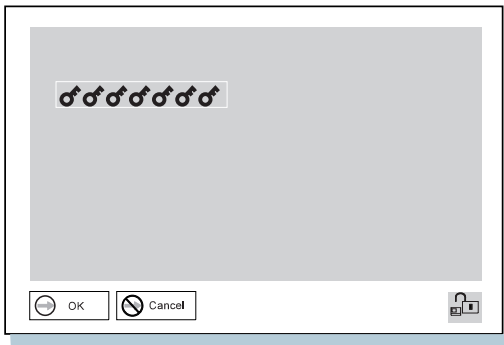

**9** Type the new password; then press **Enter**.

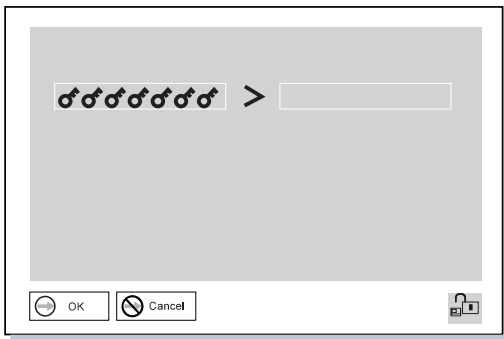

## Using Passwords

- 10 Type the new password again to verify it; then press **Enter**.



The following window appears, reminding you to write down the password and keep it in a safe place:

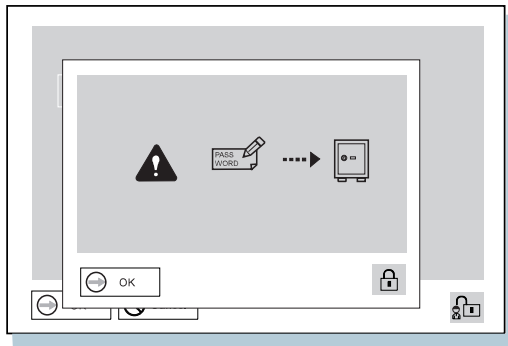

- 11 Press **Enter** again.
- 12 Click **Exit**; then click **Restart**.

The supervisor password has been changed. Your computer restarts.

### *Removing a power-on password with supervisor authority*

You can remove a power-on-password (even if you don't know it) if you know the supervisor password.

- 1 Power on the computer by pressing **F1**.  
The password prompt appears.
- 2 Enter the supervisor password.  
The "Easy-Setup" menu appears.
- 3 Select **Password** on the menu.
- 4 Select **Power on** on the menu.

## Using Passwords

**5** Type the supervisor password; then press the **Spacebar**.

**6** Press **Enter**.

A password confirmation window appears:

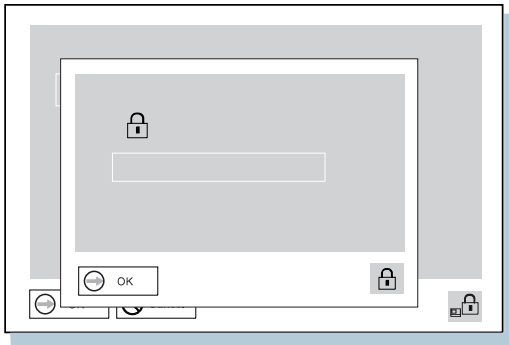

**7** Press **Enter** again.

**8** Click **Exit**; then click **Restart**.

Your computer restarts. The power-on password has been removed.

## Using the Personalization Editor

With the Personalization Editor, you can display such personal information as your name and address on the screen each time you power on your computer. This feature helps you to identify your computer when identical computers are being used in your location, or to deter theft.

### Entering your personal data

A personalized password-prompt window consists of two parts: the *personal data area* **1** and the *background bitmap area* **2**.

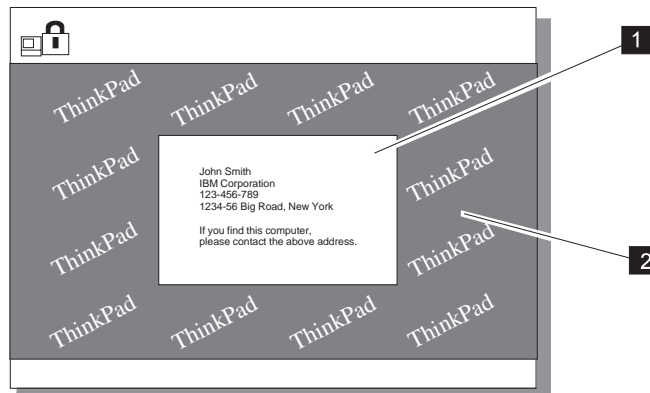

## Using the Personalization Editor

To register your name, address, and company on the Personalization Editor, do the following:



For this information to be displayed, the power-on password must already be set.

- 1** Power on the computer.
- 2** Make a backup copy of the *Personalization Data Update Diskette* with the Software Selections CD. (For more information → “Backing up your system” on page 30.)
- 3** Insert the backup copy of the *Personalization Data Update Diskette* into the diskette drive.
- 4** Open the **Personalization Editor**.
  - a) Click **Start**.
  - b) Move the cursor to **Programs** and **ThinkPad**; then click **Personalization Editor**.

The following window appears:

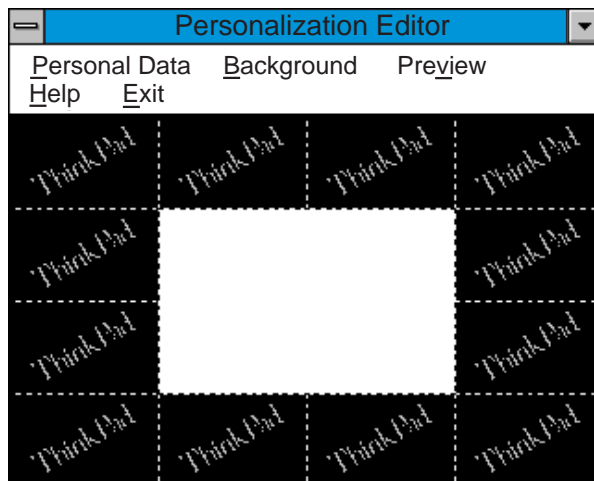



## Using the Personalization Editor

- 5** Click **Personal Data** and type the necessary information into the boxes; click **OK** to save your data.

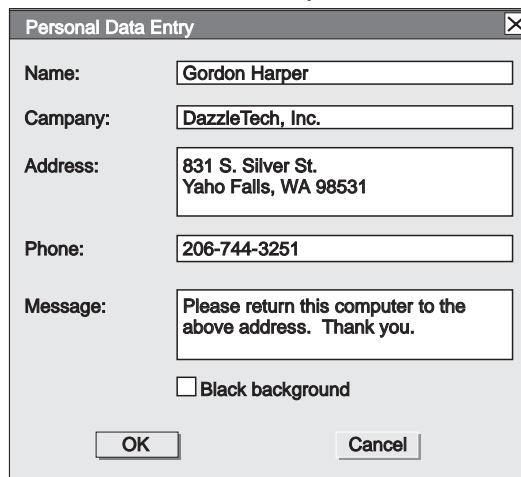

If you want to create the background bitmap, continue with step 6; otherwise, go to step 10.

- 6** Select **Background** in the “Personalization Editor” window.

Windows Paint automatically opens.

- 7** Draw an image or color the background.

Your bitmap size must be 160 x 100 pixels. To change the size, select **Image** and then **Attribute**. Specify a **Width** of 160 and a **Height** of 100, and set **Unit** to pixels.

- 8** Select **File** and **Save As** to save and name your drawing as a 16-color bitmap file on the backup copy of the *Personalization Data Update Diskette*.



To preview the actual full size of the screen, select **Preview**.

- 9** Press **Enter** to return to the preceding window.
- 10** Shut down the system, and power off the computer.

## Using the Personalization Editor

- 11** Insert the backup copy of the *Personalization Data Update Diskette* into the diskette drive; then power on the computer.
- 12** Select **Update personalization data** at the menu window; then follow the instructions on the window.  
Your data is copied from the *Personalization Data Update Diskette* and stored in the nonvolatile memory in the computer.
- 13** After the data is stored, power off the computer.
- 14** Set your password if you have not yet set it.  
Click **Help** for more information.

The information that you have typed in will be displayed the next time you power on the computer.

## Deleting the personalization window

To delete the personalization window and revert to the default password prompt, do the following:

- 1** Power off the computer.
- 2** Insert the backup copy of the *Personalization Data Update Diskette* into the diskette drive; then power on the computer.
- 3** Select **Delete personalization data** from the menu; then follow the instructions on the screen.
- 4** After the data is updated, restart the computer.

## Using locks

You can attach a mechanical lock to your computer, to help prevent it from being removed without your permission.

Attach a mechanical lock to the keyhole of the computer; then secure the chain on the lock to a stationary object. Refer to the instructions shipped with the mechanical lock. For information on the keyhole location → page 4.

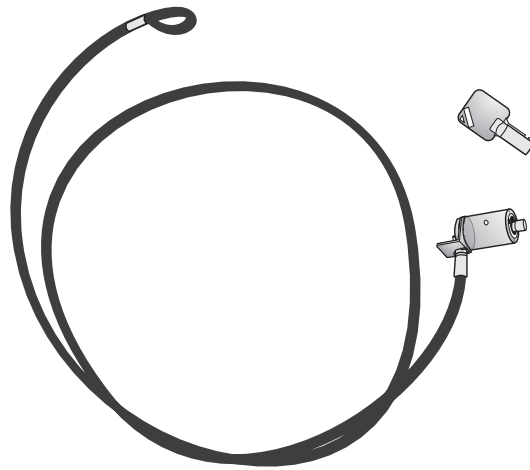

You are responsible for evaluating, selecting, and implementing the locking devices and security features. IBM makes no comments, judgments, or warranties about the function, quality, or performance of locking devices and security features.

## *Using the security screw*

### **Using the security screw**

You can use the security screw shipped with your computer to prevent devices, such as a hard disk drive, from being removed easily.



**Security screw**

To replace the coin screw with the security screw, do as follows:

- 1** Power off the computer; then disconnect the AC Adapter and all cables from the computer.
- 2** Remove the screw with a coin; then install the security screw and tighten it with a 2.5-mm allen wrench.
- 3** Connect the AC Adapter; then power on the computer.



# Chapter 4

## Solving computer problems



Hints and tips	112
Using a docking station	114
Using the USB connector	114
Using the DVD-ROM drive	115
Using a PC Card	115
Using a second CardBus card	116
Using a microphone	116
Troubleshooting guide	117
Troubleshooting charts	118
Error codes or messages	119
No error codes or messages	125
Input problems	125
Suspend or hibernation problems	127
LCD problems	131
Indicator problems	132
Battery problems	132
A hard-disk-drive problem	133
CD-ROM drive problems	134
DVD drive problems	135
Infrared communication problems	137
Audio or telephony problems	138
A universal serial bus (USB) problem	139
PC Card or PCI modem problems	139
Other PC Card problems	141
Docking station or port replicator problems	143
A printer problem	147
External monitor problems	147
A television problem	151
Other option problems	152
Software problems	153
Other problems	153
Testing your computer	155

## Hints and tips

This section provides hints and tips, as well as information on limitations.



### For Windows 98:

- In Windows 98, entering suspend mode and resuming normal operation takes longer than in Windows 95. This performance difference is a result of Windows 98, not of the features of ThinkPad.

For more information about Windows 98, see the following site:

<http://www.ibm.com/thinkpad/>

For technical support, see the following site:

<http://www.ibm.com/support/>

- Three power modes are available: **standby mode**, **suspend mode**, and **hibernation mode**. You can enter these modes as follows:
  - **Fn + F3**      standby mode
  - **Fn + F4**      suspend mode
  - **Fn + F12**     hibernation mode

There are other ways to enter suspend mode or hibernation mode. For example, you can click the **Start** button at the bottom left on the Windows 98 screen; then, on the **Shut Down...** menu, select **Stand by**. The computer enters suspend mode.



The term *standby* in the Windows 98 window has a different meaning from the term *standby mode* in this book.

Also, you can set the **system standby timer** in the “Power Management Properties” window to specify a timeout for entering suspend mode.



**For Windows 95:**

- If you are using the Intel USB camera and the system resumes from suspend mode, the USB camera is disabled. To enable it, unplug it and plug it in again.
- If a CD-ROM or DVD-ROM drive is installed in UltralimBay, the property settings on the drive might cause your computer not to enter suspend mode or hibernation mode at the end of the timeout period specified in the ThinkPad Configuration program. If you want to use suspend mode and hibernation mode, change the properties of the CD-ROM or DVD-ROM drive as follows:
  1. Click **Start** and move the cursor to **Settings** and **Control Panel**. Then click **Control Panel**.
  2. Double-click **System**.
  3. Click the **Device Manager** tab, and double-click **CD-ROM**.
  4. Click the CD-ROM or DVD-ROM drive name under **CD-ROM**; then click **Properties**.
  5. Click the **Settings** tab and clear the **Auto insert notification** check box in **Options**.
  6. Click **OK** to restart the computer.



**For Windows NT:**

- For Windows NT 4.0, hibernation is not supported if the drive is formatted by NTFS.

For more information, refer to the following Web site:

**<http://www.ibm.com/support/>**

- If you insert a PC Card into the PC Card slot, there might be an **X** mark in the list of the card information in the "PC Card [PCMCIA] Device" window in the **Control Panel**. The **X** does not affect any function, however.

## Hints and tips

### Using a docking station

For USB connector considerations related to the use of a docking station → “Using the USB connector.”

#### *Hot or warm docking to a docking station (Windows 95 and Windows 98 only)*

You might not be able to hot- or warm-dock your computer to the SelectaDock docking station when certain PCI cards, PnP ISA cards, and PC Cards are installed in the docking station. If such a condition occurs, restart the system.

#### *Using a PC Card with the docking station*

In Windows 95 or Windows NT, you need to install the PC Card support software *after* docking your computer to the docking station. If you have already installed the PC Card support software, uninstall it and then reinstall it after you dock your computer to the docking station.

### Using the USB connector

If your computer tries to enter suspend mode and the request is rejected, the device in the USB connector might be disabled. If this occurs, do a hot-unplug-and-plug operation for the USB device.

*For PCI Cards in the SelectaDock III docking station:* If the setting of the USB connector on your computer is enabled (the default setting), do not use a PCI Video Card and a PCI Network Card at the same time in the SelectaDock III docking station. If both cards are inserted, your system cannot boot.

*For the USB connector setting on the SelectaDock III docking station:* Do not disable the USB connector on the SelectaDock III. If you disable it, the system might hang during a hot- or warm-dock or -undock operation. If this occurs, restart the system.



## Using the DVD-ROM drive

Do not switch the display mode from the LCD to the external monitor while viewing a DVD with video content, such as a DVD movie or a business presentation. You need to change the display mode before you open an MPEG file to play.

## Using a PC Card

- After your computer returns from standby mode to normal operation, you cannot perform hot-plug and -unplug operations for certain Network PC Cards in the docking station slots. To solve the problem, restart the system.
- If you are communicating with a PC Card modem or inserting a PC Card in a PC Card slot, do not enter your computer into suspend mode, enter into hibernation mode, or click **Stand by** in the “Shut Down Window” window.

**Note:** If you want to enter your computer into suspend mode, first stop the PC Card in the “PC Card (PCMCIA) Properties” window as follows:

1. Click **Start**, move the cursor to **Settings**, and click **Control Panel**.
2. Double-click **PC Card (PCMCIA)**.
3. From the list, select the card you are stopping.
4. Click **Stop**.

If you remove a communication PC Card from the PC Card slot and reinsert it later, it might not work correctly. You need to restart your computer.

- If you install a PC Card after replacing a CD-ROM drive with a diskette drive, and then later reinsert the CD-ROM drive, the card might lose its resource name for working. A CD-ROM drive (secondary IDE) always uses IRQ 15, but after the CD-ROM drive is replaced with a diskette drive, IRQ 15 will be free, and Windows 95 or Windows 98 will assign it to a new PC Card. But IRQ 15 must be taken over with IDE2 when a CD-ROM drive is reinserted.

## *Hints and tips*

### **Using a second CardBus card**

If a CardBus card is already configured in your computer, you must configure a second CardBus card manually by using the Device Manager. To get to the Device Manager, click the **System** icon in the Control Panel.

### **Using a microphone**

If you are using a microphone with your computer, use the ThinkPad-option headset. Some microphones, such as condenser microphones, might need a battery. See the instructions that come with the microphone.

#### *Using an external condenser microphone*

The microphone jack supports the following types of microphone:

- A dynamic microphone
- A self-battery-powered condenser microphone
- An electric condenser microphone

## Troubleshooting guide

The following chart shows how to find or solve a problem.

**If a beep sounds, if a message appears, or if a function-related problem occurs:**

- 1** Find your symptom from the table, and try to solve the problem. → “Troubleshooting charts” on page 118.
- 2** If you can't solve the problem, run the test and make sure the hardware and the device drivers are OK. → “Testing your computer” on page 155.
- 3** Note the error code and have the computer serviced. → “Getting Service” in the *Online User's Guide*.

**If you accidentally lose or damage software in your computer:**

- Recover it by using either the Software Selections CD or Recovery CD. → “Using the Software Selections CD” on page 30 and “Using the Recovery CD” on page 32.

## Troubleshooting charts

If your computer has an error, it typically displays a message or an error code, or a beep sounds when you power it on. Look for your problem in the following lists of troubleshooting charts. If you find it, go to the page indicated and take the specified action. The troubleshooting charts address problems in general, and some descriptions might not apply to your particular computer or suit your situation. Compare the features or options of your computer with this book or the shipping checklist.

Error codes or messages	Page 119
No error codes or messages	Page 125
Input problems	Page 125
Suspend or hibernation problems	Page 127
LCD problems	Page 131
Indicator problems	Page 132
Battery problems	Page 132
A hard-disk-drive problem	Page 133
CD-ROM drive problems	Page 134
DVD drive problems	Page 135
Infrared communication problems	Page 137
Audio or telephony problems	Page 138
A universal serial bus problem	Page 139
PC Card or PCI modem problems	Page 139
Other PC Card problems	Page 141
Docking station or port replicator problems	Page 143
A printer problem	Page 147
External monitor problems	Page 147
A television problem	Page 151
Other option problems	Page 152
Software problems	Page 153
Other problems	Page 153

## Error codes or messages

**Note:** In the charts, x can be any character.

Message	Cause and action
<p>I9990301 I9990302 I9990305</p> <p>(Incorrect connection of the hard disk drive might cause these error codes to appear.)</p>	<p>Your computer can't find the startup drive. Do the following:</p> <ol style="list-style-type: none"> <li>1. Power off the computer.</li> <li>2. Press and hold <b>F1</b>; then power on the computer to start Easy-Setup. Hold <b>F1</b> until the Easy-Setup menu appears.</li> <li>3. Select the <b>Start up</b> icon.</li> <li>4. Select the <b>Power-on</b> icon. If you are unable to set the startup sequence, have the computer serviced.</li> <li>5. Check the devices in the startup sequence box. Is the default drive listed in the startup sequence box? <ul style="list-style-type: none"> <li><b>Yes</b> Exit this window, and power off the computer.</li> <li><b>No</b> Select the <b>Reset</b> icon.</li> </ul> </li> <li>6. Is an operating system installed? <ul style="list-style-type: none"> <li><b>Yes</b> Go to step 8.</li> <li><b>No</b> Install the operating system in your computer.</li> </ul> </li> <li>7. After you install the operating system, power off the computer.</li> <li>8. Power on the computer.</li> </ol> <p>If the same message appears, have the computer serviced.</p>
<p>I99xxxxx (except the above I999030x errors)</p>	<p>Have the computer serviced.</p>
<p>111 (docking station error)</p>	<p>If you are using a port replicator or a docking station, disconnect it; then reconnect it.</p> <p>If you still have a problem, refer to the manual shipped with your port replicator or docking station.</p>

## Troubleshooting guide

Message	Cause and action
<p>158 (supervisor password error)</p>	<p>A hard disk drive was installed with a different supervisor password, or it did not have a hard disk password.</p> <p>The hard disk drive with the error can be in any of the following:</p> <ul style="list-style-type: none"> <li>• The main bay of your computer</li> <li>• The UltralimBay</li> <li>• The UltraBay tray of the docking station attached to your computer.</li> </ul> <p>To solve the problem, do the following:</p> <ol style="list-style-type: none"> <li>1. Make sure a hard disk drive without the error is installed in the main hard disk bay of your computer. <ul style="list-style-type: none"> <li>If the hard disk drive is installed in the UltraBay tray of the docking station, power off the computer and reinstall it into the main hard disk bay of your computer. Then power the computer on again.</li> </ul> </li> <li>2. Press <b>Enter</b>.</li> <li>3. Type your supervisor password at the power-on password prompt. <ul style="list-style-type: none"> <li>If the 00158 error appears again, press <b>Enter</b> to proceed to the Easy-Setup "Password" submenu.</li> </ul> </li> <li>4. Select the <b>Supervisor</b> icon; then press <b>Enter</b>. <ul style="list-style-type: none"> <li>The same password as the supervisor password is set for the hard disk password on the main hard disk bay.</li> </ul> </li> <li>5. Restart the computer.</li> </ol>
<p>159 (supervisor password error)</p>	<p>The hard disk password differs from the supervisor password.</p> <p>The hard disk drive with the error can be in any of the following:</p> <ul style="list-style-type: none"> <li>• The main hard disk drive bay of your computer</li> <li>• The UltralimBay</li> <li>• The UltraBay tray of the docking station attached to your computer</li> </ul> <p>To solve the problem, do the following:</p> <ol style="list-style-type: none"> <li>1. Make sure that the hard disk drive password and the supervisor password differ. <ul style="list-style-type: none"> <li>If the hard disk drive is in the UltraBay tray of the docking station, power off the computer and reinstall the drive into the main bay of your computer. Then power on the computer again.</li> </ul> </li> <li>2. At the hard disk password prompt, change the hard disk password to the supervisor password.</li> </ol>



## Troubleshooting guide

Message	Cause and action
16x or 17x (undefined date or configuration error)	Follow the instructions on the screen.
174 (device configuration error)	Make sure that the hard disk drive and the device in the UltraslimBay are firmly installed. If the problem persists, have the computer serviced.
175, 177, 178 (EEPROM error)	Have the computer serviced.
183 (invalid password error)	The password entered at the supervisor password prompt is invalid. Check your supervisor password.
184 (invalid password error)	The password entered is invalid. Power off the computer and wait at least 5 seconds; then power it on again and type the correct password.
185 (startup sequence error)	The startup sequence is invalid. Power off the computer and wait at least 5 seconds; then power it on again to reset the startup sequence in Easy-Setup.
188,189 (EEPROM checksum error)	Have the computer serviced.
190 (critical low-battery error)	The computer powered off, because the battery is low. Connect the AC Adapter to the computer and charge the battery pack, or replace the battery pack with a fully charged one.
192 (cooling fan error)	Have the computer serviced.
195 (hibernation error)	The system configuration differs between the time your computer entered hibernation mode and the time it exited this mode, and your computer cannot resume normal operation. <ul style="list-style-type: none"> <li>• Change the system configuration to what it was before your computer entered hibernation mode.</li> <li>• If the memory size was changed, re-create the hibernation file.</li> </ul> If you are using a docking station, undock the computer from the docking station before you enter hibernation mode.
196 (hibernation error)	The computer cannot read the hibernation file. Have the computer serviced.
225 (unsupported memory)	The installed DIMM is not supported. <b>Note:</b> For example, this error occurs if you attempt to install EDO DRAM or 66-MHz SDRAM, which your computer does not support.

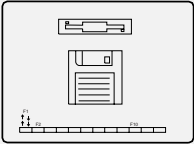

## Troubleshooting guide

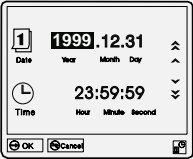
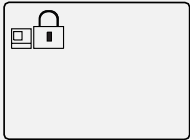
Message	Cause and action
2xx (memory error)	Make sure that the DIMM option is correctly installed.
30x (keyboard error)	<p>Make sure that no object is placed on the keyboard or on the external keyboard, if you have one. Power off the computer and power off all attached devices. Power on the computer first; then power on the attached devices.</p> <p>If you still have a problem, do the following:</p> <ul style="list-style-type: none"> <li>• If an external keyboard is connected, do the following: <ul style="list-style-type: none"> <li>– Power off the computer and disconnect the external keyboard; then power on the computer. Make sure that your keyboard operation is correct. If it is, have the external keyboard serviced.</li> <li>– Make sure that the external keyboard is connected to the correct connector.</li> </ul> </li> <li>• Test the computer by using the PC-Doctor. <ul style="list-style-type: none"> <li>– If the computer stops during the test, have the computer serviced.</li> </ul> </li> </ul>
6xx (diskette error)	Have the computer serviced.
11xx (serial port error)	Have the computer serviced.
12xx (infrared error)	Have the computer serviced.
17xx (hard disk error)	Have the computer serviced.
1801 (unsupported port replicator)	The attached port replicator is not supported.
24xx (video error)	Have the computer serviced.
808x (PC Card slot error)	Have the computer serviced.
860x (pointing device error)	Make sure that the external mouse or the external keyboard is connected correctly. If it is connected correctly, have the computer serviced.
<b>Diskette and F1 prompts</b> 	<p>Make sure that the hard disk drive is correctly installed.</p> <p>Or, make sure that the self-starting diskette is inserted correctly (with the label facing up and metal-shutter end first) in the diskette drive.</p> <p>If it is, press <b>F1</b>. If both prompts remain, have the computer serviced.</p>

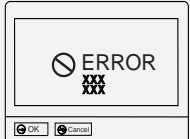

Message	Cause and action
<p>A 163 error appears and then the <i>Date and Time</i> window appears.</p> 	<p>Neither the date nor the time is set in the computer.</p> <p>Set the date and time by typing or clicking on ▲ or ▼ to set the values; then click on <b>OK</b>.</p> <p>If both the power-on password and supervisor password are set, do the following:</p> <ol style="list-style-type: none"> <li>1. Power on the computer. The password prompt appears after the error code.</li> <li>2. Type the supervisor password, not the power-on password. An error window appears.</li> <li>3. Click on <b>OK</b> or press <b>Enter</b>.</li> <li>4. Set the time and date in the next window; then press <b>Enter</b>. The system restarts.</li> </ol> <p><b>Note:</b> If the power-on password is rejected, reset the power-on password, using Easy-Setup.</p>
<p>The power-on password prompt</p> 	<p>A power-on password or supervisor password is set. Type the correct password and press <b>Enter</b> to use the computer (see page 96).</p> <p>If the power-on password is not accepted, a supervisor password might have been set. Type the supervisor password and press <b>Enter</b>.</p> <p>If you still have a problem, have the computer serviced.</p>
<p>The hard disk password prompt</p> 	<p>A hard disk password is set. Type the correct password and press <b>Enter</b> to use the computer (see page 96).</p> <p>If you still have a problem, have the computer serviced.</p>
	<p>This message appears when you restart your computer after you have changed the IDE channel from 2 to 3. Power off the computer and wait at least 5 seconds; then power it on again.</p>
<p>A POST error prompt</p> 	<p>An error was found during POST. Test the computer, using PC-Doctor.</p> <p>If the test ends in an error, note the error code and have the computer serviced.</p>

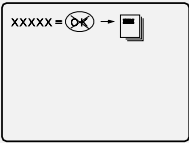
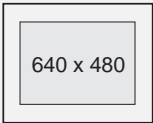
## Troubleshooting guide

Message	Cause and action
<p>An error prompt</p> 	<p>Test the computer, using PC-Doctor.</p> <p>If the test ends in an error, note the error code and have the computer serviced.</p> <p>You can start the operating system by pressing <b>F1</b> instead, and ignore the error.</p>
<p>The DOS full-screen looks smaller.</p> 	<p>If you use a DOS application that supports only 640 x 480 resolution (VGA mode), the screen image might look slightly distorted or might appear smaller than the display size. This is to maintain compatibility with other DOS applications. To expand the screen image to the same size as the actual screen, start the ThinkPad Configuration program and click on <b>LCD</b> (  ); then select the <b>Screen expansion</b> function. (The image might still look slightly distorted.)</p> <p><b>Note:</b> You can use the <b>Fn + F8</b> keys to do the same thing if your computer has screen expansion function.</p>
<p>A panel or message that is not listed in the troubleshooting charts.</p>	<p>Test the computer, using PC-Doctor.</p> <p>If the test ends in an error, note the error code and have the computer serviced.</p>
<p>xxxxx <b>KB OK</b> appears and the computer stops.</p>	<p>Have the computer serviced.</p>

## No error codes or messages

Problem	Cause and action
<p>The screen is blank and you do not hear any beeps.</p> <p><b>Note:</b> If you are not sure whether you heard any beeps, power off the computer; then power it on again, and listen again. If you are using an external monitor, go to “External monitor problems” on page 147.</p>	<p>If a power-on password is set, press any key to display the power-on password prompt, and then type the correct password and press <b>Enter</b> (see page 96).</p> <p>If the power-on password does not appear, the brightness control lever might be set to minimum brightness. Adjust the brightness level.</p> <p>If the screen still remains blank, make sure that:</p> <ul style="list-style-type: none"> <li>• The battery pack is installed correctly.</li> <li>• The AC Adapter is connected to the computer and the power cord is plugged into a working electrical outlet.</li> <li>• The computer power is on. (Turn on the power switch again for confirmation.)</li> </ul> <p>If these items are correct and the screen remains blank, have the computer serviced.</p>
<p>The screen is blank and you hear a continuous beep, or two or more beeps.</p>	<p>Have the computer serviced.</p>
<p>Only the cursor appears.</p>	<p>Reinstall your operating system, and power on the computer.</p> <p>If you still have a problem, have the computer serviced.</p>

## Input problems

Problem	Cause and action
<p>The cursor does not move after the computer awakens from one of the power management modes.</p>	<p>Make sure you followed the instructions in the <i>Online User's Guide</i> correctly when you installed Windows with the Advanced Power Management (APM) option.</p>

## Troubleshooting guide

Problem	Cause and action
All or some keys on the keyboard do not work.	<ul style="list-style-type: none"> <li>• If the problem occurred immediately after the computer returned from suspend mode, enter the power-on password if it is set.</li> <li>• If an external keyboard is connected, the numeric keypad on your computer does not work. This is not a defect.</li> <li>• If an external numeric keypad or a mouse is connected:               <ol style="list-style-type: none"> <li>1. Power off the computer.</li> <li>2. Remove the external numeric keypad or the mouse.</li> <li>3. Power on the computer and try using the keyboard again.</li> </ol> </li> <li>• If the keyboard problem is not resolved, check the connection of the external numeric keypad, external keyboard, or mouse.</li> </ul> <p>If you still have a problem, have the computer serviced.</p>
The cursor drifts when the computer is powered on or after it resumes normal operation.	<p>The cursor might drift when you are not using the TrackPoint during normal operation. This is a normal characteristic of the TrackPoint and is not a defect. Cursor drifting might occur for several seconds under the following conditions:</p> <ul style="list-style-type: none"> <li>• When the computer is powered on.</li> <li>• When the computer resumes normal operation.</li> <li>• When the TrackPoint is pressed for a long time.</li> <li>• When the temperature changes.</li> </ul>
The cursor does not work for a while after the settings in the "TrackPoint Properties" window have been changed.	<p>This is a normal characteristic of the cursor. Wait several seconds until the cursor returns to the normal state.</p>
The mouse or pointing device does not work.	<ul style="list-style-type: none"> <li>• Make sure that the pointing-device cable is enabled in the ThinkPad Configuration program.</li> <li>• Make sure that the mouse or pointing-device cable is securely connected to the computer.</li> <li>• Try using the TrackPoint. If the TrackPoint works, the error might be due to the mouse.</li> <li>• If your mouse is incompatible with the IBM PS/2 mouse, disable the TrackPoint, using the ThinkPad Configuration program.</li> </ul> <p><b>Note:</b> See the manual supplied with the mouse for more information.</p>
The mouse buttons do not work.	<p>Change the mouse driver to <b>Standard PS/2 Port Mouse</b>, and then reinstall <b>PS/2 TrackPoint</b>. See the <i>Online User's Guide</i> for how to install the driver.</p>
The scrolling or magnifying glass function does not work.	<p>See the <b>General</b> tab page in "Mouse Properties," and make sure that the <b>PS/2 TrackPoint</b> driver is installed.</p>
A number appears when you type a letter.	<p>The numeric lock function is on. To disable it, press and hold <b>Shift</b>; then press <b>NumLk</b>.</p>

## Troubleshooting guide

Problem	Cause and action
All or some keys on the external numeric keypad do not work.	Make sure that the external numeric keypad is correctly connected to the computer.
All or some keys on the external keyboard do not work.	<p>To use an external keyboard, you need to attach the keyboard/mouse cable to the computer. Make sure that:</p> <ul style="list-style-type: none"> <li>• The keyboard/mouse cable is correctly connected to the computer.</li> <li>• The keyboard cable is connected to the correct side of the keyboard/mouse cable.</li> </ul> <p>If these items are correct, disconnect the keyboard/mouse cable from the computer and make sure that the operation of the system keyboard is correct. If the system keyboard works, have the keyboard/mouse cable or the external keyboard serviced.</p>

## Suspend or hibernation problems

Problem	Cause and action
The computer enters suspend mode automatically.	The computer enters suspend mode automatically when the processor temperature reaches a certain level. This is not a defect.
The computer enters suspend mode immediately after POST (the suspend indicator turns on).	<p>Make sure that:</p> <ul style="list-style-type: none"> <li>• The battery pack is charged.</li> <li>• The operating temperature is within the acceptable range. Refer to Appendix A.</li> </ul> <p>If these items are correct, have the computer serviced.</p>
Error 190 appears, and the computer immediately powers off.	The battery power is getting low. Connect the AC Adapter to the computer, or replace the battery pack with a fully charged one.
The LCD is blank after resuming.	Check if an external monitor was disconnected while the computer was in suspend mode. <b>Do not disconnect the external monitor while the computer is in suspend mode or hibernation mode. If no external monitor is attached when the computer resumes, the LCD remains blank and output is not displayed. This restriction does not depend on the resolution value.</b>
The computer does not return from suspend mode, or the suspend indicator stays on and the computer does not work.	<p>The computer automatically enters suspend or hibernation mode when the battery power is empty. Do one of the following:</p> <ul style="list-style-type: none"> <li>• Replace the battery pack with a fully charged one, and then press <b>Fn</b>.</li> <li>• Connect the AC Adapter to the computer; then press <b>Fn</b>.</li> </ul>



## Troubleshooting guide

Problem	Cause and action
When you are using the port replicator, resuming normal operation from hibernation or suspend mode takes a long time.	<p>If you have not connected the network cable, the computer queries the Ethernet until the timeout timer is reached. Connect the network cable if you want to use the Ethernet. If you are not using the network, disable the Ethernet port as follows:</p> <p><b>For Windows 98:</b></p> <ol style="list-style-type: none"><li>1. Double-click the <b>System</b> icon in the <b>Control Panel</b>.</li><li>2. Click the <b>Device Manager</b> tab.</li><li>3. Double-click <b>Network Adapter</b>.</li><li>4. Double-click <b>Intel EtherExpress PRO PCI Adapter</b>.</li><li>5. Select the <b>Disable in this hardware profile</b> check box.</li><li>6. Click <b>OK</b>.</li><li>7. Close all windows.</li><li>8. Restart the computer.</li></ol> <p><b>For Windows NT:</b></p> <ol style="list-style-type: none"><li>1. Double-click the <b>Devices</b> icon in the <b>Control Panel</b>.</li><li>2. Select <b>Intel EtherExpress PRO Adapter</b> and click <b>Stop</b>.</li><li>3. Click <b>Startup...</b> and select <b>Disabled</b>.</li><li>4. Click <b>OK</b>.</li><li>5. Click <b>Close</b>.</li><li>6. Close all windows.</li><li>7. Restart the computer by powering it off and on again.</li></ol>
Your computer does not enter suspend or hibernation mode.	Check if any option has been selected to disable your computer from entering suspend or hibernation mode. For more information → <a href="#">Online User's Guide</a> .

## Troubleshooting guide

Problem	Cause and action
<p>The computer does not enter suspend mode as set by the timer under Windows 98 or Windows NT.</p>	<p><b>For Windows 98:</b> The Windows 98 generic CD-ROM or DVD driver accesses the internal CD-ROM drive or DVD drive every 3 seconds to see if a CD-ROM is inserted in the CD-ROM drive or DVD drive. This prevents your computer from entering suspend mode even after a timeout.</p> <p>To prevent this from occurring, do the following:</p> <ol style="list-style-type: none"><li>1. Click <b>Start</b>.</li><li>2. Move the cursor to <b>Settings</b> and <b>Control Panel</b>.</li><li>3. Click <b>Control Panel</b>, and then double-click <b>System</b>.</li><li>4. Click the <b>Device Manager</b> tab.</li><li>5. Click the + mark of <b>CD-ROM</b>.</li><li>6. Double-click the CD-ROM or DVD name.</li><li>7. Click the <b>Setting</b> tab.</li><li>8. Clear the <b>Auto insert notification</b> check box.</li></ol> <p>Windows 98 no longer detects the CD-ROM or DVD insertion automatically.</p> <p><b>For Windows NT:</b> The computer does not enter suspend mode through the timer if you enable the CD-ROM AutoRun feature. To enable the timer in this situation, edit the configuration information in the registry as follows:</p> <pre>HKEY_LOCAL_MACHINE\SYSTEM\CurrentControlSet\Services\Cdrom\</pre> <p>Autorun: 0x1 → Autorun: 0</p>

## Troubleshooting guide

Problem	Cause and action
<p>The computer does not enter hibernation mode with the <b>Fn + F12</b> key combination.</p>	<p>Enable hibernation mode as follows:</p> <p><b>For Windows 98:</b></p> <ol style="list-style-type: none"> <li>1. Start the ThinkPad Configuration program.</li> <li>2. Click <b>Power Management</b> ().</li> <li>3. Click the <b>Hibernation</b> tab.</li> <li>4. Click <b>Enable hibernation...</b></li> <li>5. Click <b>Create Now</b>.</li> </ol> <p>If you are using one of the IBM communication PC Cards, the computer cannot enter hibernation mode.</p> <p>To enter hibernation mode, stop the communication program, and then remove the PC Card; or else disable the PC Card slot, using the <b>Control Panel</b>.</p> <p><b>For Windows NT:</b></p> <p><b>Note:</b> To use hibernation mode in Windows NT, you must format your hard disk with the FAT format system. If you format your hard disk with NTFS, the Windows NT default format, you cannot use hibernation mode.</p> <ol style="list-style-type: none"> <li>1. Start the ThinkPad Configuration program.</li> <li>2. Click <b>Power Management</b> ().</li> <li>3. Click <b>Suspend/Resume Options</b> ().</li> <li>4. Click <b>Enable Hibernation</b>.</li> <li>5. Click <b>OK</b>.</li> </ol> <p>If you are using one of the IBM communication PC Cards, the computer cannot enter hibernation mode.</p> <p>To enter hibernation mode, stop the communication program, and then remove the PC Card; or else disable the PC Card slot, using the <b>Control Panel</b>.</p>



## LCD problems

Problem	Cause and action
<p>The screen is unreadable or distorted.</p>	<p>Make sure that:</p> <ul style="list-style-type: none"> <li>• The display device driver is installed correctly.</li> <li>• The display resolution and color depth are correctly set.</li> <li>• The monitor type is correct.</li> </ul> <p>To check these settings, do as follows:</p> <p><b>For Windows 98:</b></p> <ol style="list-style-type: none"> <li>1. Click <b>Start</b>.</li> <li>2. Move the cursor to <b>Settings</b> and <b>Control Panel</b>.</li> <li>3. Click <b>Control Panel</b>, and then double-click <b>Display</b>.</li> <li>4. Click the <b>Settings</b> tab.</li> <li>5. Make sure that the color depth and resolution are correctly set.</li> <li>6. Click <b>Advanced...</b></li> <li>7. Click the <b>Adapter</b> tab. Make sure that "NeoMagic MagicMedia 256ZX" is shown in the adapter information window.</li> <li>8. Click the <b>Monitor</b> tab. make sure that the information is correct.</li> </ol> <p><b>For Windows NT:</b></p> <ol style="list-style-type: none"> <li>1. Click <b>Start</b>.</li> <li>2. Move the cursor to <b>Settings</b> and <b>Control Panel</b>.</li> <li>3. Click <b>Control Panel</b>, and then double-click <b>Display</b>.</li> <li>4. Click the <b>Settings</b> tab.</li> <li>5. Make sure that the color depth and resolution are correctly set.</li> <li>6. Click <b>Display Type...</b> Make sure that "NeoMagic MagicMedia 256ZX" is shown in the "Display Type" window.</li> <li>7. Click <b>OK</b>.</li> <li>8. Click the <b>Test</b> button in the "Settings" window. Make sure that the output is displayed correctly.</li> </ol>
<p>Incorrect characters appear on the screen.</p>	<p>Did you install the operating system or application program correctly? If they are installed and configured correctly, have the computer serviced.</p>
<p>The screen stays on even after you power off your computer.</p>	<p>Press the reset switch with the tip of a pen and power off your computer; then power it on again.</p>
<p>Missing, discolored, or bright dots appear on the screen every time you power on your computer.</p>	<p>This is an intrinsic characteristic of the TFT technology. Your computer's display contains multiple thin-film transistors (TFTs). A small number of missing, discolored, or bright dots on the screen might exist all the time.</p>

## Troubleshooting guide

### Indicator problems

Problem	Cause and action
The battery status indicator does not go on even though a battery pack is installed in the computer.	The over-current protection device inside the battery pack has been activated. Wait several hours and try again. If the indicator does not go on, replace the battery pack or have the computer serviced.
The <b>diskette-drive-in-use</b> icon stays on.	<ul style="list-style-type: none"><li>• If a diskette is in the drive, make sure that:<ul style="list-style-type: none"><li>– The internal or external diskette drive is firmly connected to the computer.</li><li>– The diskette contains the necessary files to start the system.</li><li>– There is nothing wrong with your application program.</li><li>– There is nothing wrong with the diskette.</li><li>– The diskette is inserted correctly in the diskette drive—label facing up and metal-shutter end first.</li></ul>If these items are correct, have the computer serviced.</li><li>• If there is no diskette in the drive, have the computer serviced.</li></ul>

### Battery problems

Problem	Cause and action
The battery pack cannot be fully charged in 3.5 hours by the power-off charging method.	The battery pack might be over-discharged. Do the following: <ol style="list-style-type: none"><li>1. Power off the computer.</li><li>2. Make sure that the over-discharged battery pack is in the computer.</li><li>3. Connect the AC Adapter to the computer and let it charge.</li></ol> If the battery pack cannot be fully charged in 24 hours, use a new battery pack. If the optional Quick Charger is available, use it to charge the over-discharged battery pack.
Your computer shuts down before the battery status indicator shows empty, <b>–or–</b> Your computer operates after the battery status indicator shows empty.	Discharge and recharge the battery pack.

## *Troubleshooting guide*

<b>Problem</b>	<b>Cause and action</b>
The operating time for a fully charged battery pack is short.	Discharge and recharge the battery pack. If you still have a problem, use a new battery pack.
The computer does not operate with a fully charged battery pack.	The over-current protective function in the battery pack might be activated. Power off the computer for 1 minute to reset this function; then power it on again.
The battery pack cannot be charged.	The battery pack might not be able to be charged when it is hot. In that case, remove it from the computer and leave it at room temperature for a while. After it cools down, reinstall it and recharge it. If it still cannot be charged, have it serviced.

## **A hard-disk-drive problem**

<b>Problem</b>	<b>Cause and action</b>
The hard disk drive makes an intermittent rattling noise.	<p>The rattling noise might be heard when:</p> <ul style="list-style-type: none"><li>• The hard disk drive starts accessing the data or when it stops.</li><li>• You are carrying the hard disk drive.</li><li>• You are carrying your computer.</li></ul> <p>This is a normal characteristic of a hard disk drive and is not a defect.</p>

## CD-ROM drive problems

Problem	Cause and action
<p>The CD-ROM drive does not work.</p>	<p>Make sure that:</p> <ul style="list-style-type: none"> <li>• The computer is powered on and a compact disc is properly loaded on the center pivot of the CD-ROM drive. (You should hear a click.)</li> <li>• The CD-ROM drive connector is firmly connected to the computer.</li> <li>• The CD-ROM drive tray is firmly closed.</li> <li>• The device drivers are correctly installed.</li> </ul> <p>If the CD-ROM drive in the docking station does not work, do the following:</p> <ol style="list-style-type: none"> <li>1. Click <b>Start</b>.</li> <li>2. Move the cursor to <b>Programs</b> and <b>ThinkPad</b>; then click <b>ThinkPad Configuration</b>.</li> <li>3. Click <b>Docking Station</b> ().</li> <li>4. Make sure that you selected the <b>Enable IDE device in the docking station</b> check box.</li> </ol> <p><b>Note:</b> Do not use IRQ 11 and 15 for the PCI device setting.</p> <ol style="list-style-type: none"> <li>5. Click <b>OK</b>.</li> </ol>
<p>You hear a noise from the CD-ROM drive when the compact disc is spinning.</p>	<p>The CD-ROM drive cover might be bent. Have the CD-ROM drive serviced.</p>
<p>The CD-ROM tray does not open even if you press the CD-ROM eject button.</p>	<p>Insert a pin into the CD-ROM emergency eject hole and eject the CD-ROM tray.</p>
<p>A compact disc cannot be read.</p>	<p>Make sure that:</p> <ul style="list-style-type: none"> <li>• The compact disc is not dirty. If it is, clean it with a CD-ROM cleaner kit.</li> <li>• The compact disc is not defective. If it is, try another compact disc.</li> <li>• The compact disc is placed in the tray with the label side up. (You should hear a click.)</li> <li>• The compact disc format conforms with one of the following: <ul style="list-style-type: none"> <li>– Music CD</li> <li>– CD-ROM or CD-ROM XA</li> <li>– Multisession photo CD</li> <li>– Video CD</li> </ul> </li> </ul>

## DVD drive problems

Problem	Cause and action
The DVD does not work.	<p>Make sure that:</p> <ul style="list-style-type: none"> <li>• The computer is powered on and a DVD or a compact disc is properly loaded on the center pivot of the DVD drive. (You should hear a click.)</li> <li>• The DVD drive connector is firmly connected to the computer.</li> <li>• The DVD drive tray is firmly closed.</li> <li>• The device drivers are correctly installed.</li> </ul> <p>If the DVD drive in the docking station does not work, do the following:</p> <ol style="list-style-type: none"> <li>1. Click <b>Start</b>.</li> <li>2. Move the cursor to <b>Programs</b> and <b>ThinkPad</b>; then click <b>ThinkPad Configuration</b>.</li> <li>3. Click <b>Docking Station</b> ().</li> <li>4. Make sure that you selected the <b>Enable IDE device in the docking station</b> check box.</li> </ol> <p><b>Note:</b> Do not use IRQ 11 and 15 for the PCI device setting.</p> <ol style="list-style-type: none"> <li>5. Click <b>OK</b>.</li> </ol>
You hear a noise from the DVD drive when the DVD is spinning.	The DVD drive cover might be bent. Have the DVD drive serviced.
The DVD tray does not open even if you press the DVD eject button.	Insert a pin into the DVD emergency eject hole and eject the DVD tray.
The DVD cannot be read.	<p>Make sure that:</p> <ul style="list-style-type: none"> <li>• The DVD is not dirty. If it is, clean it.</li> <li>• The DVD is not defective. If it is, try another DVD.</li> <li>• The DVD is loaded on the center pivot of the DVD drive with the label side up. (You should hear a click.)</li> <li>• The DVD format conforms with one of the following: <ul style="list-style-type: none"> <li>– Music CD</li> <li>– CD-ROM or CD-ROM XA</li> <li>– Multisession photo CD</li> <li>– Video CD</li> <li>– DVD (DVD-video)</li> </ul> </li> </ul>

## Troubleshooting guide

Problem	Cause and action
<p>If you play the DVD Express with Windows 98 or Windows 95, the “No valid Disk/Drive found” message appears.</p>	<p>This message appears when you reboot or restart your computer with the DVD left in the DVD drive. Remove the DVD from the drive and then reinsert it.</p> <p>If the problem persists, check the drive assignments. Assignments should not skip letters. Suppose, for example, that you have assigned the letter C to the hard disk drive and the letter E to the DVD drive, but you have not assigned the letter D to anything. In this case, you would need to assign the letter D to the DVD drive. To change the drive letter from E to D, do the following:</p> <ol style="list-style-type: none"><li>1. Click <b>Start</b>, move the cursor to <b>Settings</b>, and click <b>Control Panel</b>.</li><li>2. Double-click <b>Device Manager</b>.</li><li>3. Double-click the letter currently assigned to your DVD drive (for example, E).</li><li>4. Click the <b>Settings</b> tab.</li><li>5. Select <b>D</b> in “Start drive letter” under “Reserved drive letters.”</li><li>6. Click <b>OK</b>, and restart the computer.</li></ol>

## Infrared communication problems

Problem	Cause and action
Your computer cannot communicate with other devices using the infrared port.	<p>Make sure that:</p> <ul style="list-style-type: none"> <li>• The communication speeds are the same.</li> <li>• The infrared ports are clean.</li> <li>• No objects are between the computer and the communicating device.</li> <li>• The distance and angle between your computer and the device is within the specified range.</li> <li>• You are not operating under direct sunlight.</li> <li>• The infrared port is directly facing the other communication port.</li> <li>• Communication is not impeded by light from the computer's LCD. To avoid this, open the LCD to a wide angle.</li> <li>• The communication application running on your computer is compatible with that running on the other computer. Refer to the application manuals for more information.</li> </ul>
Incorrect data is sent between your computer and a communicating device.	<p>Make sure that:</p> <ul style="list-style-type: none"> <li>• The distance and angle between your computer and the device are within the set ranges.</li> <li>• The communication speeds are the same.</li> <li>• There are no other devices that radiate infrared rays, such as remote-controlled devices or wireless headphones, near your computer or the communicating device.</li> <li>• You are not operating under direct sunlight.</li> <li>• No fluorescent lamps are near your computer or the communicating device.</li> </ul>
You cannot use DMA channels for both the parallel connector and the infrared port.	<p>If you enable ECP and choose DMA3 (the default value) for the parallel connector, you might be prompted if you want to disable DMA for the infrared port. To use DMA channels for both the parallel and infrared ports, do the following:</p> <ol style="list-style-type: none"> <li>1. Click <b>OK</b> to disable DMA for the infrared port.</li> <li>2. Close a parallel port panel.</li> <li>3. Click the <b>Infrared device</b> button to open the infrared panel.</li> <li>4. Choose DMA0 or DMA1 for the infrared port on the panel.</li> <li>5. If the panel shows a prompt asking whether you want to disable DMA for an audio device, click <b>OK</b>.</li> </ol>

## Troubleshooting guide

### Audio or telephony problems

Problem	Cause and action
The voice quality over the voice-over-data communication is poor.	Because of limitations of the ThinkPad modem, the voice quality that is transmitted and received over the voice-over-data communication is not as good as with a normal telephone line. There might be momentary voice discontinuities, delays, or distortions.
<i>(Windows 98 or Windows 95 users:)</i> Wave or MIDI sound does not play correctly.	Make sure the built-in audio device is configured correctly. <b>For Windows 98 and Windows 95:</b> <ol style="list-style-type: none"><li>1. Click <b>Start</b>.</li><li>2. Move the cursor to <b>Program</b>; then click <b>Control Panel</b>.</li><li>3. Double-click <b>System</b>.</li><li>4. Click the <b>Device Manager</b> tab.</li><li>5. Click the + mark by <b>Sound, video and game controller</b>.</li><li>6. Make sure the following devices are enabled and configured correctly:<ul style="list-style-type: none"><li>• Crystal SoundFusion Game Device</li><li>• Crystal SoundFusion Joystick</li><li>• Crystal SoundFusion PCI audio Accelerator</li><li>• Crystal SoundFusion Virtual MPU-401</li></ul></li></ol>
<i>(Windows 95 users:)</i> During the reinstallation of the audio driver, the error message appears.	Install the audio driver by doing the following: <ol style="list-style-type: none"><li>1. Start Windows 95.</li><li>2. Run the SETUP.EXE in the directory the driver is in. The "Crystal Audio Setup" window appears.</li><li>3. Click <b>Uninstall Crystal Drivers</b>.</li><li>4. Click <b>Shut down</b>.</li><li>5. Power on the computer. The system detects <b>PCI Multimedia Audio Device</b>. The "Update Device Driver Wizard" appears.</li><li>6. Click <b>Next</b>.</li><li>7. Click <b>Other Location</b>. The "Select Other Location" window appears.</li><li>8. In the location section, type the name of the directory the driver is in.</li><li>9. Click <b>OK</b>.</li><li>10. Windows 95 detects the updated driver.</li><li>11. Click <b>Finish</b>. The "Insert Disk" window appears.</li><li>12. Click <b>OK</b>. The "Copying Files" window appears.</li><li>13. Type the driver location and click <b>OK</b>. You have installed the audio driver, and Windows 95 detects some audio devices.</li></ol>



## Troubleshooting guide

Problem	Cause and action
Other problems.	<p>Problems might be due to such other factors as:</p> <ul style="list-style-type: none"><li>• Incompatibility between the ThinkPad Modem feature and other adapter cards in the docking station. To isolate this problem to a card or device, remove the adapter cards in the docking station one by one, and start the PC-Doctor.</li><li>• The telephone cable configuration is not correct for your application.</li><li>• The telephone cable is defective.</li><li>• The telephone is defective.</li><li>• The audio cable configuration is not correct for your application.</li><li>• The audio cable is defective.</li><li>• The audio equipment is defective.</li></ul>

## A universal serial bus (USB) problem

Problem	Cause and action
A device connected to the USB connector does not work.	<p>Do the following:</p> <ol style="list-style-type: none"><li>1. Make sure that the USB device is connected correctly.</li><li>2. Open the "Device Manager" window. Make sure that the USB device setup is correct and that the computer resource assignment and device driver installation are correct.</li></ol> <p><b>Note:</b> To open the "Device Manager" window, click <b>Start</b> and move the cursor to <b>Settings</b> and <b>Control Panel</b>. Double-click <b>Control Panel</b>, and <b>System</b>. Then click the <b>Device Manager</b> tab in the "System Properties" window.</p> <p>Refer to "Testing your computer" on page 155, and run the PC-Doctor for a diagnostic test of the USB connector.</p>

## PC Card or PCI modem problems

Problem	Cause and action
The PCI modem does not work.	<p>The operating system might be sharing the same IRQ levels as your modem. The PCI modem might not work under these conditions. You must cancel the IRQ shared condition to use the modem.</p> <p>To cancel the IRQ shared condition → <i>Online User's Guide</i>.</p>

## Troubleshooting guide

Problem	Cause and action
<p>Your modem application does not work with the ThinkPad modem.</p>	<p>Make sure that the internal modem port is enabled, either by opening the “Device Manager” window and running the <b>Modem Wizard</b>, or by opening the ThinkPad Configuration program and doing as follows:</p> <ol style="list-style-type: none"> <li>1. Click <b>Start</b>.</li> <li>2. Move the cursor to <b>Programs</b> and <b>ThinkPad</b>; then click <b>ThinkPad Configuration</b>.</li> <li>3. Click <b>Internal Modem</b> (  ).</li> <li>4. Select <b>Enable</b>.</li> <li>5. Click <b>OK</b>.</li> </ol> <p>If the modem does not work correctly, → <i>Online User's Guide</i>.</p> <p>If the modem works correctly, set the following modem settings by doing the following:</p> <ol style="list-style-type: none"> <li>1. Click <b>Start</b>.</li> <li>2. Move the cursor to <b>Settings</b> and <b>Control Panel</b>.</li> <li>3. Click <b>Control Panel</b>, and then double-click <b>Modem</b>. <b>Lucent Win Modem</b> is highlighted.</li> <li>4. Click <b>Properties</b>, <i>not Dialing Properties</i>.</li> <li>5. Click the <b>Connection</b> tab.</li> <li>6. Clear the <b>Wait for dial tone before dialing</b> check box.</li> <li>7. Click <b>Advanced</b>.</li> <li>8. Clear the <b>Use error control</b> check box.</li> <li>9. Select the <b>Use flow control</b> check box, and make sure that <b>Hardware (RTS/CTS)</b> is selected.</li> <li>10. Click <b>OK</b> to close the window.</li> <li>11. Click <b>OK</b> and return to the “Modem Properties” window.</li> <li>12. Click <b>Dialing Properties</b>, fill in all boxes, and click either <b>Tone dialing</b> or <b>Pulse dialing</b>.</li> </ol> <p><b>Note:</b> Most telephones today use tone dialing, where each button produces a different tone, instead of pulse dialing.</p> <ol style="list-style-type: none"> <li>13. Click <b>OK</b>.</li> <li>14. Click <b>Close</b> to close the window.</li> <li>15. Close all active windows.</li> </ol> <p>Run your modem application again.</p>
<p>Your modem application does not work in the Windows 95 environment.</p>	<p>Make sure that:</p> <ul style="list-style-type: none"> <li>• The modem is connected correctly.</li> <li>• The ! mark is to the left of the <b>Lucent Win Modem</b> in the “Device Manager” window.</li> </ul> <p>If the ! mark is there, there might be a system resource conflict with the other port.</p>

Problem	Cause and action
Your PC Card modem does not work.	Make sure that the infrared port is disabled and the modem is set up correctly by following the instructions in this book or manuals shipped with your PC Card modem.

## Other PC Card problems

Problem	Cause and action
The PC Card shows "Ready," but it does not work correctly.	<p>Make sure that:</p> <ul style="list-style-type: none"> <li>The system resources reserved for the PC Card do not conflict with other system devices.</li> </ul> <p>➔ <i>Online User's Guide.</i></p> <ul style="list-style-type: none"> <li>The resources reserved for the PC Card match the settings in the application program.</li> </ul> <p>If you are using a modem card, check the COM number, the I/O port address, and the IRQ level. If you are using a network card, check the I/O port address, the IRQ level, and the memory window address. To check the resources assigned to the PC Card, click <b>PC Card Slots</b> and the <b>Allocated Resources</b> tab in the ThinkPad Configuration program.</p>
A system resource conflict occurred when a PC Card was used.	➔ <i>Online User's Guide.</i>
PC Card support software does not recognize your PC Card.	<p>Make sure that:</p> <ul style="list-style-type: none"> <li>If the PC Card is not a modem, an ATA, a Flash, or an SRAM card, you have the proper client device driver for the card. In Windows 95, the PC Card must have an INF file associated with it.</li> <li>Your PC Card is working by following the diagnostic instructions for your PC Card, if any.</li> </ul>
The PC Card is recognized by PC Card support software, but the "Not Ready" or "Not Configured" message is shown.	<p>Make sure that:</p> <ul style="list-style-type: none"> <li>The PC Card enabler is installed. Refer to the manuals supplied with your PC Card.</li> <li>If the PC Card is not a modem, an ATA, a Flash, or an SRAM card, you have the proper client device driver for the card. In Windows 95, the PC Card must have an INF file associated with it.</li> <li>The resources for the PC Card are correctly reserved. ➔ <i>Online User's Guide.</i></li> </ul>

## Troubleshooting guide

Problem	Cause and action
<p>The system cannot start from the PC Card.</p>	<p>To start from the PC Card, do as follows:</p> <ol style="list-style-type: none"> <li>1. Start the ThinkPad Configuration program.</li> <li>2. Click the <b>UltraslimBay</b> () button.</li> <li>3. Clear the <b>Enable Hot/Warm Swapping of UltraslimBay</b> check box.</li> <li>4. Click <b>OK</b>.</li> </ol> <p>Make sure that the correct system resources are being used for the PC Card.</p> <p><b>ATA:</b>                   IRQ 15 I/O X'170'–X'177', X'376'</p> <p>                                  <b>Note:</b> The secondary IDE should be disabled.</p> <p><b>RPL (Token Ring):</b>   IRQ 9 Memory: X'D0000'–X'D3FFF' I/O: X'A20'–X'A23'</p> <p><b>RPL (Ethernet):</b>     IRQ 5 Memory X'D2000'–X'D7FFF' I/O X'300'–X'31F'</p>
<p>The PC Card is installed and configured, but it does not work.</p>	<ul style="list-style-type: none"> <li>• <b>Modem card:</b> Make sure that all settings in the “Modem Control” panel and in your communication application correspond and are correct.</li> <li>• <b>SCSI card:</b> Make sure that the correct driver for the SCSI card is installed. <b>Note:</b> You can insert SCSI cards while you are operating your computer; however, it is recommended that you insert them at boot time.</li> <li>• <b>Network card:</b> Make sure that all network components are correctly installed.</li> <li>• <b>Combo card:</b> Make sure that the correct driver for the Combo card is installed. Restart the system, and then insert the Combo card.</li> </ul>

## Troubleshooting guide

Problem	Cause and action
<p>The computer is disconnected from the network when it attempts to access using a PC Card on battery operation.</p>	<p>Your computer limits the processor speed on battery operation to save battery life; however, some network cards do not allow processor control. Do as follows:</p> <ol style="list-style-type: none"> <li>1. Click <b>Start</b>.</li> <li>2. Move the cursor to <b>Settings</b>; then click <b>Control Panel</b>.</li> <li>3. Double-click the <b>ThinkPad Configuration</b> icon.</li> <li>4. Click <b>Power Management</b>. The "Power Management Properties" window appears.</li> <li>5. Click the <b>Power Mode</b> tab.</li> <li>6. Make sure that <b>Battery</b> is selected in the <b>Power Source</b> list box. If it is not, select <b>Battery</b>.</li> <li>7. Click the <b>Customized</b> radio button.</li> <li>8. Select <b>Maximize</b> in the <b>Processor speed</b> list box under <b>Setting details</b>.</li> <li>9. Click <b>OK</b> to apply the changes.</li> </ol>

## Docking station or port replicator problems

Problem	Cause and action
<p>The IDE CD-ROM drive or the hard disk drive in the docking station does not work.</p>	<p>Make sure that the system resources of the secondary IDE device in the docking station do not conflict with the system resources of the other devices. Do the following:</p> <ol style="list-style-type: none"> <li>1. Click on <b>Start</b>.</li> <li>2. Move the cursor to <b>Programs</b> and <b>ThinkPad</b>; then click on <b>ThinkPad Configuration</b>.</li> <li>3. Click on <b>Docking Station</b> () , and then on the <b>Device Manager</b> tab.</li> <li>4. Make sure that the ! mark is not to the left of the <b>CD-ROM</b> or its drivers.</li> </ol> <p>To enable the device → "Enabling the IDE drive on the docking station" on page 84.</p>

## Troubleshooting guide

Problem	Cause and action
<p>The MIDI connector on the port replicator does not work.</p>	<p>To enable the MIDI connector of the port replicator, use the ThinkPad Configuration program. Make sure that the MIDI connector is enabled by doing the following:</p> <ol style="list-style-type: none"> <li>1. Start the ThinkPad Configuration program.</li> <li>2. Click <b>MIDI/Joystick Port</b>.</li> <li>3. Confirm that the MIDI connector is enabled. If not, click <b>Enable</b>; then click <b>OK</b>.</li> <li>4. Close the ThinkPad Configuration program and restart the computer.</li> </ol> <p><b>Note:</b> When you restart the computer, you might need to install the MIDI device driver for your computer's operating system. Follow the instructions on the screen.</p>
<p>The computer hangs when you power on or resume operation.</p>	<p>Make sure that:</p> <ul style="list-style-type: none"> <li>• The AC Adapter is connected to the port replicator or the docking station. To do this, follow the instructions presented in this book → page 80.</li> <li>• The power-on indicator of the docking station is on.</li> <li>• The computer is securely attached to the port replicator, or the computer and the port replicator are securely attached to the docking station.</li> </ul> <p>If there is still a problem, refer to the manuals shipped with the port replicator and the docking station.</p>
<p>The PC Card installed in a docking station is not recognized, and the PC Card slots are unusable.</p>	<p>Make sure that:</p> <ul style="list-style-type: none"> <li>• The AC Adapter is connected to the port replicator.</li> <li>• The power-on indicator of the docking station is on.</li> <li>• The computer is securely attached to the port replicator, or the computer and the port replicator are securely attached to the docking station.</li> </ul>
<p><i>(Windows 98 or Windows 95 users:)</i> The computer hangs during hot or warm undocking when the PC Card Enabler with Advanced EtherJet Feature is being attached.</p>	<p>With the PC Card Enabler with Advanced EtherJet Feature docked to the system:</p> <ol style="list-style-type: none"> <li>1. Click <b>Start</b>.</li> <li>2. Move the cursor to <b>Settings</b>, and <b>Control Panel</b>; then click <b>Control Panel</b>.</li> <li>3. Double-click <b>System</b>.</li> <li>4. Click <b>Device Manager</b> tab.</li> <li>5. Double-click <b>Network Adapter</b>.</li> <li>6. Double-click <b>Ethernet Adapter</b>. The "Ethernet Adapter Properties" window appears.</li> <li>7. Clear the <b>Exists in all hardware profiles</b> check box (for Windows 98 or for Windows 95 OSR2 or later version), <b>or</b> clear the <b>Undocked configuration</b> check box (for Windows 95 OSR0 or OSR1).</li> <li>8. Click <b>OK</b> to apply the changes.</li> </ol>

## Troubleshooting guide

Problem	Cause and action																								
<ul style="list-style-type: none"> <li>• After you warm-dock your computer to the port replicator under Windows 95, PC Cards in the docking station or the Port Replicator with Advanced EtherJet Feature cannot be recognized.</li> <li>• After the computer resumes from a power management mode under Windows 95, PC Card modems, SCSI cards, ATA cards, 3Com Combo Cards, or CardBus Cards in the docking station or the Port Replicator with Advanced EtherJet Feature do not work.</li> </ul>	<ol style="list-style-type: none"> <li>1. Start Windows 95</li> <li>2. Insert the Software Selections CD into the CD-ROM or DVD-ROM drive.</li> <li>3. At the DOS prompt, type:  <pre style="margin-left: 20px;">COPY src_cd:\DATA\WIN95\cc\W95UPD\PCI.VXD C:\WINDOWS\SYSTEM</pre>                     and press <b>Enter</b>.                      You are prompted to confirm that it is okay to overwrite the file.</li> <li>4. Type Y and press <b>Enter</b>.</li> </ol> <p><b>Notes:</b></p> <ol style="list-style-type: none"> <li>1. src_cd is the drive letter of the CD-ROM or DVD-ROM drive.</li> <li>2. cc is the country code, as follows:                             <table style="margin-left: 20px; border: none;"> <tr> <td><b>Denmark</b></td> <td>DK</td> <td><b>Netherlands</b></td> <td>NL</td> </tr> <tr> <td><b>Finland</b></td> <td>FL</td> <td><b>Norway</b></td> <td>NO</td> </tr> <tr> <td><b>France</b></td> <td>FR</td> <td><b>Spain</b></td> <td>SP</td> </tr> <tr> <td><b>Germany</b></td> <td>GR</td> <td><b>Sweden</b></td> <td>SW</td> </tr> <tr> <td><b>Italy</b></td> <td>IT</td> <td><b>United States</b></td> <td>US</td> </tr> <tr> <td><b>Japan</b></td> <td>JP</td> <td></td> <td></td> </tr> </table> </li> </ol>	<b>Denmark</b>	DK	<b>Netherlands</b>	NL	<b>Finland</b>	FL	<b>Norway</b>	NO	<b>France</b>	FR	<b>Spain</b>	SP	<b>Germany</b>	GR	<b>Sweden</b>	SW	<b>Italy</b>	IT	<b>United States</b>	US	<b>Japan</b>	JP		
<b>Denmark</b>	DK	<b>Netherlands</b>	NL																						
<b>Finland</b>	FL	<b>Norway</b>	NO																						
<b>France</b>	FR	<b>Spain</b>	SP																						
<b>Germany</b>	GR	<b>Sweden</b>	SW																						
<b>Italy</b>	IT	<b>United States</b>	US																						
<b>Japan</b>	JP																								
<p>When you insert the PC Card into the docking station or the Port Replicator with Advanced EtherJet Feature under Windows 95, the system restarts.</p>	<ol style="list-style-type: none"> <li>1. Start Windows 95.</li> <li>2. Insert the Software Selections CD into the CD-ROM or DVD-ROM drive.</li> <li>3. Click <b>Start</b> and move the cursor to <b>Program</b>; then click <b>Windows Explorer</b>.</li> <li>4. Click the drive letter of the CD-ROM or DVD-ROM drive.</li> <li>5. Double-click <b>PCMCIA.REG</b> under DATA\WIN95\cc\W95UPD</li> <li>6. Click <b>OK</b>.</li> </ol> <p><b>Note:</b> cc is the country code. For details, refer to the "Cause and action" description for the preceding problem.</p>																								

## Troubleshooting guide

Problem	Cause and action
<p>During the installation of the PC Card Enabler with Advanced EtherJet Feature driver, the error message appears.</p>	<p>Install the driver by doing the following:</p> <ol style="list-style-type: none"><li>1. Using the SelectaBase 600, attach the computer to the PC Card Enabler with Advanced EtherJet Feature.</li><li>2. Start Windows 95.</li><li>3. While creating a docking configuration, the computer detects the "PCI Ethernet Controller." The "Update Device Driver Wizard" window appears.</li><li>4. Click <b>Next</b>.</li><li>5. Click <b>Other Location</b>. The "Select Other Location" window appears.</li><li>6. Type the name of the directory that contains the driver for the PC Card Enabler with Advanced EtherJet Feature.</li><li>7. Click <b>OK</b>. Windows 95 finds the updated driver.</li><li>8. Click <b>Finish</b>. The "Insert Disk" window appears.</li><li>9. Type the driver location, and click <b>OK</b>. The "Network" window appears.</li><li>10. Click <b>OK</b>.</li><li>11. Enter your computer name and a work group.</li><li>12. Click <b>Close</b>. The <b>Insert Disk</b> window appears, and asks for the Windows 95 CD-ROM.</li><li>13. Click <b>OK</b>. You have installed the PC Card Enabler with Advanced EtherJet Feature driver. The "Insert Disk" window appears.</li><li>14. Click <b>OK</b>.</li><li>15. Type the location of the driver, and click <b>OK</b>.</li><li>16. Restart your computer.</li></ol>



## A printer problem

Problem	Cause and action
The printer does not work.	<p>Make sure that:</p> <ul style="list-style-type: none"> <li>• The parallel port is enabled.               <ol style="list-style-type: none"> <li>1. Click <b>Start</b>.</li> <li>2. Move the cursor to <b>Programs</b> and <b>ThinkPad</b>; then click <b>ThinkPad Configuration</b>.</li> <li>3. Click <b>Parallel Port</b> ().</li> <li>4. Select <b>Enable</b>.</li> <li>5. Click <b>OK</b>.</li> </ol> </li> <li>• The printer is powered on and ready to print.</li> <li>• The printer signal cable is connected to the correct connector of your computer.</li> </ul> <p>If these items are correct and the printer still does not work, run the tests described in the printer manual. If the tests show that the printer is OK, have the computer serviced.</p>

## External monitor problems

Problem	Cause and action
The external monitor is blank.	<p>Do the following:</p> <ol style="list-style-type: none"> <li>1. Connect the external monitor to another computer to make sure it works.</li> <li>2. Reconnect the external monitor to your computer.</li> <li>3. Refer to the manual shipped with the external monitor to check the resolutions and refresh rates that are supported.</li> <li>4. Start the ThinkPad Configuration program.</li> <li>5. Select one of the <b>Display Device</b> buttons on the toolbar in the ThinkPad Configuration program:           <ul style="list-style-type: none"> <li>• If the external monitor supports the same resolution as the LCD, or a higher resolution, click <b>CRT Display Only</b> or <b>Both LCD and CRT Display</b>.</li> <li>• If the external monitor supports a lower resolution than the LCD, click <b>CRT Display Only</b>. (If you click the <b>Both LCD and CRT Display</b>, the external monitor screen will be blank or distorted.)</li> </ul> </li> </ol>

## Troubleshooting guide

Problem	Cause and action
<p>You cannot set a higher resolution than the present one on your external monitor.</p>	<p>Make sure that:</p> <ul style="list-style-type: none"><li>• The display driver is installed correctly by doing the following: <b>For Windows 98:</b><ol style="list-style-type: none"><li>1. Click <b>Start</b>.</li><li>2. Move the cursor to <b>Settings</b> and <b>Control Panel</b>.</li><li>3. Click <b>Control Panel</b>, and then double-click <b>Display</b>.</li><li>4. Click the <b>Settings</b> tab.</li><li>5. Click <b>Advanced...</b></li><li>6. Click the <b>Adapter</b> tab. Make sure that "NeoMagic MagicMedia 256ZX" is shown in the adapter information window.</li><li>7. Click <b>OK</b>. If you are not sure that the display driver is installed correctly, reinstall it.</li></ol><b>For Windows NT:</b><ol style="list-style-type: none"><li>1. Click <b>Start</b>.</li><li>2. Move the cursor to <b>Settings</b> and <b>Control Panel</b>.</li><li>3. Click <b>Control Panel</b>, and then double-click <b>Display</b>.</li><li>4. Click the <b>Settings</b> tab.</li><li>5. Click <b>Display Type...</b> Make sure that "NeoMagic MagicMedia 256ZX" is shown in the "Display Type" window.</li><li>6. Click <b>OK</b>. If you are not sure that the display driver is installed correctly, reinstall it.</li></ol></li></ul> <p>(Continued on the next page.)</p>

Problem	Cause and action
<p>You cannot set a higher resolution than the present one on your external monitor.</p>	<p>(Continued from the previous page.)</p> <p>Make sure that:</p> <ul style="list-style-type: none"> <li>• An appropriate monitor type is selected by doing the following:           <p><b>For Windows 98:</b></p> <ol style="list-style-type: none"> <li>1. Click <b>Start</b>.</li> <li>2. Move the cursor to <b>Settings</b> and <b>Control Panel</b>.</li> <li>3. Click <b>Control Panel</b>, and then double-click <b>Display</b>.</li> <li>4. Click the <b>Settings</b> tab.</li> <li>5. Click <b>Advanced...</b></li> <li>6. Click the <b>Monitor</b> tab.</li> </ol> <p>Make sure that the appropriate monitor type is shown in the monitor information window. If the monitor type is correct, click <b>OK</b> to go to step 11; otherwise do as follows:</p> <ol style="list-style-type: none"> <li>7. Click <b>Change...</b></li> </ol> <p>The "Update Device Driver Wizard" appears.</p> <ol style="list-style-type: none"> <li>8. Click <b>Next</b>, and follow the instructions on the screen by selecting <b>Display a list of all the drivers in a specific location, so you can select the driver you want</b>, and then <b>Show all hardware</b>.</li> <li>9. Select <b>Manufacturers</b> and <b>Models</b> for your monitor, and follow the instructions on the screen.</li> <li>10. After updating the driver, click <b>Close</b> to close the "Properties" window.</li> <li>11. In the "Display Properties" window, set <b>Colors</b> and <b>Screen area</b>.</li> <li>12. Click <b>OK</b>.</li> </ol> <p><b>Note:</b> If you are using Windows NT, choose only your display mode—resolution and color depth—and refresh rate. Windows NT offers no way to choose manufacturers and models.</p> </li> </ul>



## Troubleshooting guide

Problem	Cause and action
The screen is unreadable or distorted.	<p>Make sure that:</p> <ul style="list-style-type: none"><li>• The display driver is installed correctly. (Refer to the "Cause and action" of setting a higher resolution on the external monitor on page 148.)</li><li>• An appropriate monitor type is selected. (Refer to the "Cause and action" of setting a higher resolution on the external monitor on page 149.)</li><li>• An appropriate refresh rate is selected by doing the following (for Windows 98):<ol style="list-style-type: none"><li>1. Do steps 1 through 6 on page 148 for Windows 98.</li><li>2. Select the correct refresh rate for your monitor. If you are not sure, select <b>Optimal</b>.</li></ol></li></ul> <p>If the settings are correct, run the tests described in the manual supplied with the external monitor. If the tests show that the external monitor is OK, have the computer serviced.</p> <ul style="list-style-type: none"><li>• An appropriate refresh rate is selected by doing the following (for Windows NT):<ol style="list-style-type: none"><li>1. Do steps 1 through 4 on page 148 for Windows NT.</li><li>2. Make sure that the refresh rate given in the "Refresh Frequency" field is one that your monitor supports. If not, select the correct one.</li></ol></li></ul>
Wrong characters appear on the screen.	<p>Did you install the operating system or application program with the correct procedure?</p> <p>If you did, have the external monitor serviced.</p>

## A television problem

Problem	Cause and action
The screen is blank.	<p>Make sure that:</p> <ul style="list-style-type: none"><li>• You enabled the television settings. You need to enable the settings every time you start your computer to use the TV.</li><li>• You enabled the video-out connector (TV-out) by doing the following:<ol style="list-style-type: none"><li>1. Click on <b>Start</b>.</li><li>2. Move the cursor to <b>Settings</b> and <b>Control Panel</b>; then click on <b>Control Panel</b>.</li><li>3. Double-click on <b>Display</b>.</li><li>4. Select the <b>Settings</b> tab.</li><li>5. Click <b>Advanced...</b></li><li>6. Select the <b>NeoMagic</b> tab.</li><li>7. Make sure that the <b>TV</b> check box is selected.</li><li>8. Click <b>Advanced Settings</b>.</li><li>9. Select the <b>TV Options</b> tab.</li></ol>If you need to set the <b>TV Output Standards</b> and <b>Output Selection</b> in the procedure, make sure that you select the appropriate radio button under <b>TV Output Standards</b>, and the <b>Composite</b> radio button under <b>Output Selections</b>.</li></ul>

## Other option problems

Problem	Cause and action
<p>An IBM option that you just installed does not work.</p>	<p>Make sure that:</p> <ul style="list-style-type: none"> <li>• The option is designed for your computer.</li> <li>• The option was installed according to the instructions supplied with the option or this book.</li> <li>• Other installed options or cables are not loose.</li> <li>• There is no I/O address or interrupt level (IRQ) DMA channel conflict. To see the system resource status, start the ThinkPad Configuration program and click on the respective device buttons.</li> </ul> <p>If the test program for the option did not find the problem, have the computer and the option serviced.</p>
<p>An IBM option that used to work no longer works.</p>	<p>Make sure that:</p> <ul style="list-style-type: none"> <li>• The option is securely connected to your computer.</li> <li>• The option passes its own test. If the option came with its own test instructions, use those instructions to test the option.</li> <li>• There is no system resource conflict ( → <i>Online User's Guide</i>).</li> </ul> <p>If these items are correct and the test program did not find the problem, have the computer and the option serviced.</p>
<p>The serial connector does not work.</p>	<p>Make sure that the serial connector is enabled by doing the following:</p> <p><b>For Windows 98:</b></p> <ol style="list-style-type: none"> <li>1. Start the ThinkPad Configuration program.</li> <li>2. Click <b>Serial Port</b> (  ).</li> <li>3. Select <b>Enable</b>.</li> <li>4. Click <b>Device Manager</b>.</li> <li>5. Check the ports in the "Device Manager" window and make sure that the settings are correct.</li> <li>6. Click <b>OK</b>.</li> </ol> <p><b>For Windows NT:</b></p> <ol style="list-style-type: none"> <li>1. Start the ThinkPad Configuration program.</li> <li>2. Click <b>Serial Port</b> (  ).</li> <li>3. Select <b>Enable</b>; then select <b>COM1, COM2, COM3, or COM4</b>.</li> <li>4. Click <b>OK</b>.</li> </ol>

## Software problems

Problem	Cause and action
An application does not run correctly.	<p>Check the following to make sure that the problem is not being caused by the application:</p> <ul style="list-style-type: none"> <li>Your computer has the minimum required memory to run the application. Refer to the manuals supplied with the application.</li> <li>The application is designed to operate with your operating system.</li> <li>Other applications run correctly on your computer.</li> <li>The necessary device drivers are installed → <i>Online User's Guide</i>.</li> <li>The application works OK when it is run on some other computer.</li> </ul> <p>If an error message appears while you are using the application program, refer to the manuals supplied with the application.</p> <p>If these items are correct and you still have a problem, contact your place of purchase or a service representative for help.</p>
The main window bitmap in the ThinkPad Configuration program is distorted (Windows NT only).	<p>Installing the <b>Active Desktop</b>, bundled with Internet Explorer Version 4.0 on Windows NT, might cause this problem. Do one of the following:</p> <ul style="list-style-type: none"> <li>Uninstall the <b>Active Desktop</b>. (Merely disabling the <b>Active Desktop</b> is not enough to avoid the problem.)</li> <li>Close the ThinkPad Configuration program and start it again. (This is a temporary recovery.)</li> </ul>

## Other problems

Problem	Cause and action
The computer locks or does not accept any input.	<ul style="list-style-type: none"> <li>Your computer might lock when it enters suspend mode during a communication operation. Disable the suspend timer when you are working on the network.</li> <li>If you power on the computer with OS/2 Warp installed, make sure that there is no disc in the CD-ROM or DVD-ROM drive. If there is, remove it, and power off the computer by pressing the power shutdown switch with the tip of a ballpoint pen. Then power it on again.</li> </ul>
The computer does not power off with the power switch.	<p>If the suspend indicator is on and you are working under battery power, change the battery to a fully charged one or change your power source to ac power.</p> <p>If you still have a problem, press the power shutdown switch with the tip of a ballpoint pen.</p>

### ***Troubleshooting guide***

<b>Problem</b>	<b>Cause and action</b>
The computer does not start from a diskette.	Make sure that the startup sequence in the Easy-Setup is set so that the computer starts from the diskette drive (→ “Easy-Setup” on page 16).



## Testing your computer

If you have a problem with your computer, you can test it by using PC-Doctor.

To start PC-Doctor, do the following:

- 1 Click **Start**.
- 2 Move the cursor to **Programs** and **PC Doctor for Windows**.
- 3 Click **PC-Doctor for Windows**.

The following window appears:

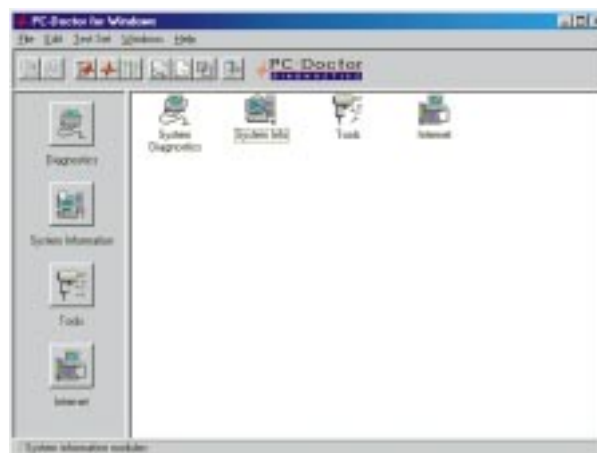

You can select the following items by clicking the navigator that is on the left of the window, or by double-clicking the icon.

- **Diagnostics** or **System Diagnostics** includes icons for testing your computer. For example, you can test your computer's memory by double-clicking the **Memory Test** icon.

You can also select such items as **Run Quick Test Set** or **Run Normal Test Set**, for thorough testing of your computer from **Test Set** on the menu bar.

- **System Information** or **System Info** includes icons for displaying information about your computer.

### *Testing your computer*

- **Tools** includes icons for starting tools, such as **System Monitor** and **Scandisk**.
- **Internet** includes icons for opening a Web site where you can find support information on your computer.

## Appendix A. Features and specifications

---

This appendix describes features and specifications for the computer.

### Features

#### Processor

- Intel® mobile Pentium® III processor

#### Memory

- Built-in: 64 MB

#### Storage devices

- 2.5-inch hard disk drive

#### Display

The color display uses TFT technology:

- Up to 1024 x 768 resolution on the LCD
- Up to 1280 x 1024 resolution on an external monitor
- Brightness control

#### Keyboard

- 84-key, 85-key, or 89-key
- TrackPoint
- **Fn** key function

## Features

### External diskette drive

To get the best performance from your diskette drives, use high-quality diskettes (such as IBM diskettes) that meet or exceed the following standards:

- **1-MB, 3.5-inch, unformatted diskette:**
  - ANSI (American National Standards Institute) X3.137
  - ISO (International Standards Organization) 8860
  - ECMA (European Computer Manufacturers Association) 100
- **2-MB, 3.5-inch, unformatted diskette:**
  - ANSI X3.171
  - ISO 9529
  - ECMA 125

### External interface

- Serial connector (EIA-RS232D)
- Parallel connector (Centronics)
- External input-device connector
- External-monitor connector
- External-diskette-drive connector
- Expansion connector
- PC Card slots (two Type I or Type II PC Cards, or one Type III PC Card)
- Headphone jack
- Line-in jack
- Microphone jack (supports a dynamic microphone, a self-battery-powered condenser microphone, or an electric condenser microphone)
- Infrared port
- Universal Serial Bus (USB) connector
- Telephone connector

## Specifications

### Size

- Width: 300 mm (11.8 in.)
- Depth: 240 mm (9.4 in.)
- Height: 36.5 mm (1.4 in.)

### Environment

**Note:**

When you charge the battery pack, its temperature must be at least 10°C (50°F).

- Temperature (at altitudes less than 2438 m [8000 ft]):
  - Operating with no diskette: 5° to 35°C (41° to 95°F)
  - Operating with a diskette: 10° to 35°C (50° to 95°F)
  - Nonoperating: 5° to 43°C (41° to 109°F)
- Relative humidity:
  - Operating with no diskette in the drive: 8% to 95%
  - Operating with a diskette in the drive: 8% to 80%
- Maximum altitude: 3048 m (10,000 ft) in unpressurized conditions
  - Maximum temperature at 3048 m (10,000 ft): 31.3°C (88° F)

### Heat output

- 56 W (191 Btu/hr) maximum

### Electrical (AC Adapter)

- Sine-wave input, at 50 to 60 Hz, is required
- Input rating of the AC Adapter: 100–240 V ac, 50/60 Hz

### Lithium-ion battery pack

- Nominal voltage: 10.8 V dc
- Capacity: 3.2 AH

## IBM power cords

## IBM power cords

### Attention

Using an improper power cord might severely damage your computer.

To use the AC Adapter outside the country or region where you purchased your computer, you need an ac power cord that is certified for the country or region you are visiting. You can purchase one through an IBM authorized reseller or IBM marketing representative in that country or region.

#### ***For 2-pin power cords:***

IBM power cord part number	Used in these countries or regions
13H5273	Japan



The grounded adapter is required for full MPRII<sup>1</sup> compliance. If a 3-pin power cord came with your computer → “Safety information” on page xii.

<sup>1</sup> MPRII is an abbreviation of an expression that is translated as low-frequency radio wave radiation regulation.

## IBM power cords

### *For 3-pin power cords:*

<b>IBM power cord part number</b>	<b>Used in these countries or regions</b>
02K0539	People's Republic of China (other than Hong Kong)
36L8867	Argentina
76H3514	Australia, New Zealand, Papua New Guinea, Paraguay, Uruguay
76H3516	Aruba, Bahamas, Barbados, Bermuda, Bolivia, Brazil, Canada, Cayman Islands, Colombia, Costa Rica, Curaçao, Dominican Republic, Ecuador, El Salvador, Guatemala, Guyana, Haiti, Honduras, Jamaica, Korea (South), Liberia, Mexico, Netherlands Antilles, Nicaragua, Panama, Peru, Philippines, Saudi Arabia, Suriname, Taiwan, Thailand, Trinidad (West Indies), United States of America, Venezuela
76H3518	Austria, Belgium, Bosnia-Herzegovina, Bulgaria, Croatia, Czech Republic, Egypt, Finland, France, Former Yugoslav Republic of Macedonia (FYROM), Germany, Greece, Hungary, Iceland, Indonesia, Macao, Netherlands, Norway, Poland, Portugal, Romania, Slovakia, Slovenia, Spain, Sweden, Turkey, Yugoslavia
76H3520	Denmark
76H3522	Bangladesh, Myanmar, Pakistan, South Africa, Sri Lanka
76H3524	Abu Dhabi, Albania, Antigua, Bahrain, Brunei, Dubai, Fiji, Hong Kong, India, Ireland, Kenya, Kuwait, Malaysia, Nigeria, Oman, Qatar, Singapore, United Kingdom
76H3528	Liechtenstein, Switzerland
76H3530	Chile, Ethiopia, Italy, Libya
76H3532	Israel
76H3535	Korea

**IBM power cords**



## Appendix B. Product warranty and notices

---

International Business Machines Corporation

Armonk, New York 10504

### Statement of limited warranty

*The warranties provided by IBM in this Statement of Limited Warranty apply only to Machines you originally purchase for your use, and not for resale, from IBM or an IBM authorized reseller. The term "Machine" means an IBM machine, its features, conversions, upgrades, elements, or accessories, or any combination of them. Machines are subject to these terms only if purchased in the United States or Puerto Rico, or Canada, and located in the country of purchase. If you have any questions, contact IBM or your reseller.*

**Machine:** IBM ThinkPad 600X and the Battery Pack

**Warranty period\*:** Three Years, One Year on the Battery Pack

*\*Elements and accessories are warranted for three months. Contact your place of purchase for warranty service information.*

### Production status

Each Machine is manufactured from new parts, or new and serviceable used parts (which perform like new parts). In some cases, the Machine may not be new and may have been previously installed. Regardless of the Machine's production status, IBM's warranty terms apply.

### The IBM warranty

IBM warrants that each Machine 1) is free from defects in materials and workmanship and 2) conforms to IBM's Official Published Specifications. IBM calculates the expiration of the warranty period from the Machine's Date of Installation. The date on your receipt is the Date of Installation, unless IBM or your reseller informs you otherwise.

During the warranty period, IBM or your reseller will provide warranty service under the type of service designated for the Machine and will manage and install engineering changes that apply to the Machine. IBM or your reseller will specify the type of service.

For a feature, conversion, or upgrade, IBM or your reseller may require that the Machine on which it is installed be 1) the designated, serial-numbered Machine and 2) at an engineering-change level compatible with the feature, conversion, or upgrade. Some of these transactions (called "Net-Priced" transactions) may include additional parts and associated replacement parts that are provided on an exchange basis. All removed parts become the property of IBM and must be returned to IBM.

Replacement parts assume the remaining warranty of the parts they replace.

If a Machine does not function as warranted during the warranty period, IBM or your reseller will repair or replace it (with a Machine that is at least functionally equivalent) without charge. If IBM or your reseller is unable to do so, you may return it to your place of purchase and your money will be refunded.

If you transfer a Machine to another user, warranty service is available to that user for the remainder of the warranty period. You should give your proof of purchase and this Statement to that user.

### Warranty service

To obtain warranty service for the Machine, you should contact your reseller or call IBM. In the United States, call IBM at **1-800-772-2227**. In Canada, call IBM at **1-800-565-3344**. You may be required to present proof of purchase.

Depending on the Machine, the service may be 1) a "Repair" service at your location (called "On-site") or at one of IBM's or a reseller's service locations (called "Carry-in") or 2) an "Exchange" service, either On-site or Carry-in.

When a type of service involves the exchange of a Machine or part, the item IBM or your reseller replaces becomes its property and the replacement becomes yours. The replacement may not be new, but will be in good working order and at least functionally equivalent to the item replaced.

## Product warranty

It is your responsibility to:

1. obtain authorization from the owner (for example, your lessor) to have IBM or your reseller service a Machine that you do not own;
2. where applicable, before service is provided —
  - a) follow the problem determination, problem analysis, and service request procedures that IBM or your reseller provide,
  - b) secure all programs, data, and funds contained in a Machine,
  - c) inform IBM or your reseller of changes in a Machine's location, and
  - d) for a Machine with exchange service, remove all features, parts, options, alterations, and attachments not under warranty service. Also, the Machine must be free of any legal obligations or restrictions that prevent its exchange; and
3. be responsible for loss of, or damage to, a Machine in transit when you are responsible for the transportation charges.

### Extent of warranty

IBM does not warrant uninterrupted or error-free operation of a Machine.

Unless IBM specifies otherwise, IBM provides non-IBM machines on an "AS IS" basis. However, non-IBM manufacturers may provide their own warranties to you.

Misuse, accident, modification, unsuitable physical or operating environment, improper maintenance by you, removal of product labels or parts identification labels, or failure caused by a product for which IBM is not responsible may void the warranties.

THESE WARRANTIES REPLACE ALL OTHER WARRANTIES, EXPRESS OR IMPLIED, INCLUDING, BUT NOT LIMITED TO, THE IMPLIED WARRANTIES OF MERCHANTABILITY AND FITNESS FOR A PARTICULAR PURPOSE. HOWEVER, SOME LAWS DO NOT ALLOW THE EXCLUSION OF IMPLIED WARRANTIES. IF THESE LAWS APPLY, THEN ALL EXPRESS AND IMPLIED WARRANTIES ARE LIMITED IN DURATION TO THE WARRANTY PERIOD. NO WARRANTIES APPLY AFTER THAT PERIOD.

In Canada, warranties include both warranties and conditions.

Some jurisdictions do not allow limitations on how long an implied warranty lasts, so the above limitation may not apply to you.

### Limitation of liability

Circumstances may arise where, because of a default on IBM's part (including fundamental breach) or other liability (including negligence and misrepresentation), you are entitled to recover damages from IBM. In each such instance, regardless of the basis on which you are entitled to claim damages, IBM is liable only for:

1. bodily injury (including death), and damage to real property and tangible personal property; and
2. the amount of any other actual loss or damage, up to the greater of \$100,000 or the charge for the Machine that is the subject of the claim.

Under no circumstances is IBM liable for any of the following:

1. third-party claims against you for losses or damages (other than those under the first item listed above);
2. loss of, or damage to, your records or data; or
3. economic consequential damages (including lost profits or savings) or incidental damages, even if IBM is informed of their possibility.

Some jurisdictions do not allow the exclusion or limitation of incidental or consequential damages, so the above limitation or exclusion may not apply to you.

This warranty gives you specific legal rights and you may also have other rights which vary from jurisdiction to jurisdiction.

## Notices

References in this publication to IBM products, programs, or services do not imply that IBM intends to make these available in all countries in which IBM operates. Any reference to an IBM product, program, or service is not intended to state or imply that only that IBM product, program, or service may be used. Any functionally equivalent product, program, or service that does not infringe any of the intellectual property rights of IBM may be used instead of the IBM product, program, or service. The evaluation and verification of operation in conjunction with other products, except those expressly designated by IBM, are the responsibility of the user.

IBM may have patents or pending patent applications covering subject matter in this document. The furnishing of this document does not give you any license to these patents. You can send license inquiries, in writing, to the IBM Director of Licensing, IBM Corporation, North Castle Drive, Armonk, NY 10504-1784, U.S.A.

## Year 2000 readiness and instructions

This is a Year 2000 Readiness Disclosure.

A product is Year 2000 Ready if the product, when used in accordance with its associated documentation, is capable of correctly processing, providing and/or receiving date data within and between the 20th and 21st centuries, provided all other products (for example, software, hardware, and firmware) used with the product properly exchange date data with it.

This IBM PC hardware product has been designed to process four-digit date information correctly within and between the 20th and 21st centuries. If your IBM computer is on when the century changes, you should turn it off and then back on again once, or restart the operating system, to ensure that the internal clock resets itself for the new century.

This IBM PC product cannot prevent errors that might occur if software you use or exchange data with is not ready for the Year 2000. IBM software that comes with this product is Year 2000 Ready. However, software from other companies might come with

## Notices

this IBM PC product. IBM cannot take responsibility for the readiness of that software. You should contact the software developers directly if you wish to verify readiness, understand limitations, or look for any software updates.

To learn more about IBM PC products and the Year 2000, visit our Web site at <http://www.pc.ibm.com/year2000>. The information and tools there can help you with your Year 2000 transition plan, especially if you have multiple IBM PCs. IBM encourages you to check periodically for updated information.

## Trademarks

The following terms are trademarks of the IBM Corporation in the United States or other countries or both:

IBM	ThinkPad
PS/2	TrackPoint
RediSafe	

Microsoft, Windows, Windows NT, and the Windows logo are trademarks of Microsoft Corporation in the United States and/or other countries.

ActionMedia, LANDesk, MMX, Pentium, and ProShare are trademarks of Intel Corporation in the United States and/or other countries. (For a complete list of Intel trademarks, see <http://www.intel.com/tradmarx.htm>)

Other company, product, or service names may be the trademarks or service marks of others.

## Electronic emission notices

### *Federal Communications Commission (FCC) Statement*

ThinkPad 600X, model number 2645

This equipment has been tested and found to comply with the limits for a Class B digital device, pursuant to Part 15 of the FCC Rules. These limits are designed to provide reasonable protection against harmful interference in a residential installation. This equipment generates, uses, and can radiate radio frequency energy and, if not installed and used in accordance with the instructions, may cause harmful interference to radio communications. However, there is no guarantee that interference will not occur in a particular installation. If this equipment does cause harmful interference to radio or television reception, which can be determined by turning the equipment off and on, the user is encouraged to try to correct the interference by one or more of the following measures:

- Reorient or relocate the receiving antenna.
- Increase the separation between the equipment and receiver.
- Connect the equipment into an outlet on a circuit different from that to which the receiver is connected.
- Consult an IBM authorized dealer or service representative for help.

Properly shielded and grounded cables and connectors must be used in order to meet FCC emission limits. Proper cables and connectors are available from IBM authorized dealers. IBM is not responsible for any radio or television interference caused by unauthorized changes or modifications to this equipment. Unauthorized changes or modifications could void the user's authority to operate the equipment. This device complies with Part 15 of the FCC Rules. Operation is subject to the following two conditions: (1) this device may not cause harmful interference, and (2) this device must accept any interference received, including interference that may cause undesired operation.

Responsible Party:

International Business Machines Corporation  
New Orchard Road  
Armonk, NY 10504  
Telephone 1-919-543-2193

## Notices

### *Industry Canada Class B Emission Compliance Statement*

This Class B digital apparatus complies with Canadian ICES-003.

### *Avis de conformité à la réglementation d'Industrie Canada*

Cet appareil numérique de la classe B est conform à la norme NMB-003 du Canada.

### *European Community Directive Conformance Statement*

This product is in conformity with the protection requirements of EU Council Directive 89/336/EEC on the approximation of the laws of the Member States relating to electro-magnetic compatibility. IBM cannot accept responsibility for any failure to satisfy the protection requirements resulting from a non-recommended modification of the product, including the fitting of non-IBM option cards.

A declaration of Conformity with the requirements of the Directive has been signed by IBM United Kingdom Limited, PO BOX 30 Spango Valley Greenock Scotland PA160AH.

This product satisfies the Class B limits of EN 55022.

## Telecommunication notice

### *Federal Communications Commission (FCC) and telephone company requirements*

1. This device complies with Part 68 of the FCC rules. A label is affixed to the device that contains, among other things, the FCC registration number, USOC, and Ringer Equivalency Number (REN) for this equipment. If these numbers are requested, provide this information to your telephone company.

**Note:** If the device is an internal modem, a second FCC registration label is also provided. You may attach the label to the exterior of the computer in which you install the IBM modem, or you may attach the label to the external DAA, if you have one. Place the label in a location that is easily accessible, should you need to provide the label information to the telephone company.

2. The REN is useful to determine the quantity of devices you may connect to your telephone line and still have those devices ring when your number is called. In most, but not all areas, the sum of the RENs of all devices should not exceed five (5). To be certain of the number of devices you may connect to your line, as determined by the REN, you should call your local telephone company to determine the maximum REN for your calling area.
3. If the device causes harm to the telephone network, the telephone company may discontinue your service temporarily. If possible, they will notify you in advance; if advance notice is not practical, you will be notified as soon as possible. You will be advised of your right to file a complaint with the FCC.
4. Your telephone company may make changes in its facilities, equipment, operations, or procedures that could affect the proper operation of your equipment. If they do, you will be given advance notice to give you an opportunity to maintain uninterrupted service.
5. If you experience trouble with this product, contact your authorized reseller, or call IBM. In the United States, call IBM at **1-800-772-2227**. In Canada, call IBM at **1-800-565-3344**. You may be required to present proof of purchase.

The telephone company may ask you to disconnect the device from the network until the problem has been corrected, or until you are sure the device is not malfunctioning.

6. No customer repairs are possible to the device. If you experience trouble with the device, contact your Authorized Reseller or see the Diagnostics section of this manual for information.
7. This device may not be used on coin service provided by the telephone company. Connection to party lines is subject to state tariffs. Contact your state public utility commission or corporation commission for information.
8. When ordering network interface (NI) service from the local Exchange Carrier, specify service arrangement USOC RJ11C.

### *Canadian Department of Communications certification label*

**NOTICE:** The Industry Canada label identifies certified equipment. This certification means that the equipment meets telecommunications network protective,

## Notices

operational and safety requirements as prescribed in the appropriate Terminal Equipment Technical Requirements documents. The Department does not guarantee the equipment will operate to the user's satisfaction.

Before installing this equipment, users should ensure that it is permissible to be connected to the facilities of the local telecommunications company. The equipment must also be installed using an acceptable method of connection. The customer should be aware that compliance with the above conditions may not prevent degradation of service in some situations. Repairs to certified equipment should be coordinated by a representative designated by the supplier. Any repairs or alterations made by the user to this equipment, or equipment malfunctions, may give the telecommunications company cause to request the user to disconnect the equipment.

Users should ensure for their own protection that the electrical ground connections of the power utility, telephone lines, and internal metallic water pipe system, if present, are connected together. This precaution may be particularly important in rural areas.

**Caution:** Users should not attempt to make such connections themselves, but should contact the appropriate electric inspection authority, or electrician, as appropriate.

**NOTICE:** The Ringer Equivalence Number (REN) assigned to each terminal device provides an indication of the maximum number of terminals allowed to be connected to a telephone interface. The termination on an interface may consist of any combination of devices subject only to the requirement that the sum of the Ringer Equivalence Numbers of all the devices does not exceed 5.

### *Étiquette d'homologation du ministère des Communications du Canada*

**AVIS :** L'étiquette d'Industrie Canada identifie le matériel homologué. Cette étiquette certifie que le matériel est conforme aux normes de protection, d'exploitation et de sécurité des réseaux de télécommunications, comme le prescrivent les documents concernant les exigences techniques relatives au matériel terminal. Le ministère n'assure toutefois pas que le matériel fonctionnera à la satisfaction de l'utilisateur.

Avant d'installer ce matériel, l'utilisateur doit s'assurer qu'il est permis de le raccorder aux installations de l'entreprise locale de télécommunications. Le matériel doit également être installé en suivant une méthode acceptée de raccordement. L'abonné ne doit pas oublier qu'il est possible que la conformité aux conditions énoncées ci-dessus n'empêche pas la dégradation du service dans certaines situations.

Les réparations de matériel homologué doivent être coordonnées par un représentant désigné par le fournisseur. L'entreprise de télécommunications peut demander à l'utilisateur de débrancher un appareil à la suite de réparations ou de modifications effectuées par l'utilisateur ou à cause de mauvais fonctionnement.



## Notices

Pour sa propre protection, l'utilisateur doit s'assurer que tous les fils de mise à la terre de la source d'énergie électrique, des lignes téléphoniques et des canalisations d'eau métalliques, s'il y en a, sont raccordés ensemble. Cette précaution est particulièrement importante dans les régions rurales.

**Avertissement** : L'utilisateur ne doit pas tenter de faire ces raccordements lui-même; il doit avoir recours à un service d'inspection des installations électriques ou à un électricien, selon le cas.

**AVIS** : L'indice d'équivalence de la sonnerie (IES) assigné à chaque dispositif terminal indique le nombre maximal de terminaux qui peuvent être raccordés à une interface. La terminaison d'une interface téléphonique peut consister en une combinaison de quelques dispositifs, à la seule condition que la somme d'indices d'équivalence de la sonnerie de tous les dispositifs n'excède pas 5.

## Notices

### Product notice requirements

The following notice applies to machines equipped with both a DVD function and a TV-out function:

This device is protected by U.S. patent numbers 4631603, 4577216, 4819098, 4907093, and other intellectual property rights. The use of Macrovision's copy protection technology in the device must be authorized by Macrovision and is intended for home and other limited pay-per-view use only, unless otherwise authorized in writing by Macrovision. Reverse engineering or disassembly is prohibited.

### Notice for Australia

The following notice applies when using the telephony functions:

FOR SAFETY REASONS, ONLY CONNECT AUSTEL PERMITTED OR CERTIFIED EQUIPMENT.

## A

audio problems 138

## B

backing up 30

battery

maximizing the life xx

problems 132

replacing 36

status, checking 12

boot

optimizing 18

sequence, setting 20

built-in devices, setting up 25

## C

calculating memory size 53

CardBus card, secondary setting 116

carrying the computer xix

CD-ROM drive

changing properties, for

Windows 95 113

problem 134

changing

cap, TrackPoint 10

date and time 19

password 99

screen color 17

startup sequence 21

cleaning the computer xix

cold docking 79

cold undocking 81

color, changing screen 17

ConfigSafe 34

configuration

program 25

setup 17

CRT

See external monitor

cursor

See TrackPoint

cursor drift 9

customizing

built-in devices 25

system 30

TrackPoint 44

## D

date, setting 19

DIMM

installing 50

removing 54

disabling

dual display function 73

numeric keypad, on keyboard 14

TrackPoint 63

diskette drive 91

enclosure, using 91

removing 92

display

See also external monitor, LCD

dual display function 71

output location, changing 65

switching between LCD and external  
monitor 12

restrictions 115

docking station

cold docking 79

cold undocking 81

docking or undocking 78

enabling the IDE device 84

hot docking 81

hot undocking 82

problems 143

resource conflict 83

using, restrictions 114

docking station (*continued*)

- warm docking 81
- warm undocking 82

drivers

- Web site, getting from 35

dual display function 71

- considerations 74
- disabling 73
- enabling 71

DVD problems 135

## E

Easy-Setup 16

- password 94

EDO DRAM 49

enabling 24

- dual display function 71
- LAN remote operation 24
- network administration 24
- numeric keypad, on keyboard 14
- TrackPoint 63
- Wake on LAN 24

enclosure, using 92

error codes 119

error messages 119

expanding screen image 13

external keyboard

- problems 126
- setting 61
- using with numeric keypad 61

external monitor

- changing display output location 65
- disconnecting, restrictions 66
- dual display function 71
- problems 147
- resolutions 66
- setting 64
- switching to LCD 12

external mouse

- problems 126
- setting 59
- using with external numeric keypad 60
- using with TrackPoint, restrictions 63

external numeric keypad

external numeric keypad (*continued*)

- setting 59
- using with external mouse 60

## F

floppy disk drive

- See diskette drive

Fn key combination 12

Fn key lock function 11

function keys and Fn key 11

## H

handling tips xvii

hard disk

- problem 133
- recovering contents 32
- upgrading 55

hard-disk-drive password 94

- changing 99
- forgetting 98
- removing 99
- setting 96

hibernation mode

- entering 12
- entering, for Windows 98 112
- problems 127
- restrictions with PC Card 36
- using CD-ROM drive with, for Windows 95 113
- with NTFS format, for Windows NT 113

hot docking 81

hot undocking 82

## I

increasing storage capacity 55

indicators 6

- problems 132

infrared port problems 137

input problems 125

installing

- memory 50
- PC Card 75

installing (*continued*)  
storage devices for UltralimBay 88

## K

keyboard  
See external keyboard  
keyboard function  
Fn key 11  
numeric keypad 14  
TrackPoint 8

## L

LAN remote operation, enabling 24  
LCD  
problems 131  
switching to external monitor 12  
location  
bottom view 4  
front view 2  
rear view 4  
lock, mechanical 109

## M

magnifying glass, TrackPoint 47  
memory 49  
calculating size 53  
increasing 55  
installing 50  
removing 54  
microphone  
types 116  
using 116  
modem, PC Card or PCI  
problems 139  
monitor  
See external monitor  
mouse  
See external mouse, TrackPoint  
muting sound 13

## N

network administration, enabling 24  
numeric keypad  
See also external numeric keypad  
on keyboard, setting 14

## O

Online User's Guide, using 29  
operating system, reinstalling 30  
options  
docking station 78  
input devices, attaching 59  
PC Card, installing 75  
port replicator 78  
problems 152

## P

password 94  
changing 99  
character, setting 97  
displaying prompt 96  
entering 96  
removing 99  
setting 96  
supervisor authority 103  
PC Card  
installing 75  
problems 141  
removing 77  
restrictions 23, 115  
stopping 77, 115  
supported 75  
types 76  
PC-Doctor 155  
Personalization Editor  
deleting 108  
setting 105  
pointer  
See TrackPoint  
port replicator problems 143  
power cord, part number 160  
power modes 112  
changing 12

- power-on password 94
  - changing 99
  - removing 99
  - setting 96
- press-to-select, TrackPoint 44
  - force adjustment 46
- printer problem 147
- problems, troubleshooting guide 117
- protecting data 34

## R

- recording sheet 40
- recovering software 30
- Recovery CD
  - restrictions 32
  - using 32
- reinstalling software 30
- remote operation, enabling 24
- removing
  - memory 54
  - password 99
  - PC Card 77
- resolutions 66
- resource conflict 83
- restoring system files 34
- restrictions
  - docking station 114
  - dual display function 74
  - external monitor, disconnecting 66
  - external mouse with TrackPoint 63
  - hibernation mode with PC Card 36
  - PC Card 23, 115
  - Recovery CD 32
  - suspend mode with PC Card 75
  - switching display modes 115
  - TrackPoint with external mouse 48, 63
- RPL, setting up for 23

## S

- safety information xii
- screen
  - color changing 17
  - expanding or shrinking image 13

- screen (*continued*)
  - problems 125, 131
- scrolling, TrackPoint 47
- SDRAM 49
- security
  - mechanical lock 109
  - password 94
  - Personalization Editor 105
  - screw 110
- security screw, using 110
- sensitivity, TrackPoint 46
- serial connector problem 152
- service, getting 38
- setup 16
- shrinking screen image 13
- simple boot flag function 18
- snapshots of system files 34
- software problems 153
- Software Selections CD 30
- sound, muting 13
- Space Saver Keyboard, using 62
- standby mode
  - entering 12
  - entering, for Windows 98 112
- startup
  - optimizing 18
  - sequence, setting 20
- storage
  - capacity, increasing 55
  - devices, installing 88
- supervisor password 95
  - changing 101
  - forgetting 98
  - removing 101
  - setting 96
- suspend mode
  - entering 12
  - entering, for Windows 98 112
  - problems 127
  - restrictions with PC Card 75
  - using CD-ROM drive with, for Windows 95 113
- system files, restoring 34
- system-status indicator 7
  - problem 132

## T

- telephone, help by 39
- telephony problems 138
- television
  - attaching 68
  - problem 151
- testing with PC-Doctor 155
- ThinkPad Configuration program 25
  - window, for Windows 98 26
  - window, for Windows NT 27
- ThinkPad Web site 35
  - help at 38
- time, setting 19
- token-ring operation, setting up for 23
- TrackPoint 8
  - changing the cap 10
  - customizing 44
  - disabling 63
  - enabling 63
  - magnifying glass 47
  - press-to-select 44
  - scrolling 47
  - sensitivity 46
  - using 9
  - using with external mouse,
    - restrictions 48, 63
- troubleshooting
  - audio problems 138
  - battery problems 132
  - CD-ROM drive problems 134
  - docking station problems 143
  - DVD drive problems 135
  - error codes 119
  - error messages 119
  - external monitor problems 147
  - hard disk drive problem 133
  - hibernation problems 127
  - indicator problems 132
  - infrared communication
    - problems 137
  - input problems 125
  - LCD problems 131
  - modem problems 139
  - no error code 125
  - no error message 125
  - other option problems 152

## troubleshooting (*continued*)

- other problems 153
- PC Card problems 141
- port replicator problems 143
- printer problem 147
- software problems 153
- suspend problems 127
- telephony problems 138
- television problem 151
- universal serial bus (USB)
  - problem 139

## U

- UltraslimBay 15
  - storage devices, replacing 88
- universal serial bus (USB)
  - camera, enabling 113
  - connector, considerations 114
  - problem 139
- upgrading hard disk 55
- USB
  - camera, enabling 113
  - connector, considerations 114
  - problem 139

## V

- virtual screen function 67
- volume, changing 13

## W

- Wake on LAN, enabling 24
- warm docking 81
- warm undocking 82
- warm-swap 89
- warranty 163
- Web site 35
  - help at 38