

AE31

MAINBOARD MANUAL

DOC No.: M01101

Rev. : A0

Date : 5, 2001

Part No. : 25-11611-20

Handling Precautions

Warning:

1. Static electricity may cause damage to the integrated circuits on the motherboard. Before handling any motherboard outside of its protective packaging, ensure that there is no static electric charge in your body.
2. There is a danger of explosion if the battery is incorrectly replaced. Replace only with the same or an equivalent type recommended by the manufacturer.
3. Discard used batteries according to the manufacturer's instructions.
4. Never run the processor without the heatsink properly and firmly attached. **PERMANENT DAMAGE WILL RESULT!**

Observe the following basic precautions when handling the motherboard or other computer components:

- Wear a static wrist strap which fits around your wrist and is connected to a natural earth ground.
- Touch a grounded or anti-static surface or a metal fixture such as a water pipe.
- Avoid contacting the components on add-on cards, motherboards, and modules with the *golden fingers* connectors plugged into the expansion slot. It is best to handle system components by their mounting brackets.

The above methods prevent static build-up and cause it to be discharged properly.

Trademark

All trademarks mentioned in this manual are registered properly of the respective owners.

Handling Precautions

This manual may not, in whole or in part, be photocopied, reproduced, transcribed, translated, or transmitted in whatever form without the written consent of the manufacturer, except for copies retained by the purchaser for personal archival purposes.

Quick Reference (German)	G-1
Quick Reference (French)	F-1
Quick Reference (Spanish)	S-1
Quick Reference (Japanese)	J-1
Quick Reference (Chinese)	C-1
Quick Reference (Simplified Chinese)	SC-1

Chapter 1 Overview

Package Checklist	1-2
The AE31 Mainboard	1-3
Main Features	1-4
ACPI Ready	1-5
FIC Unique Innovation for Users (NOVUS) - Enhanced Mainboard Features and System Support	1-6

Chapter 2 Installation Procedures

Quick Reference (from Page 2-2 to 2-4)	2-2
Mainboard Layout	2-2
1). Clear CMOS, FSB Select	2-3
2). Front Panel Block Cable Connection	2-3
3). CPU Fan Installation	2-4
1). Set System Jumpers	2-5
Clear CMOS: CLR_CMOS	2-5
FSB Speed Select: JP1	2-5
2). Install Memory Modules	2-5
3). Install the CPU	2-6
4). Install Expansion Cards	2-7
5). Connect Devices	2-9
Floppy Diskette Drive Connector	2-9
IDE Device Connectors	2-10
ATX Power Connector	2-10
Fan Connectors	2-11
CD Audio-In Connectors	2-11
Front Panel Block and Speaker Connector	2-12
Blue Tooth Audio Port Connector	2-13
Wake-On-Ring Connector:	2-14

Wake-On-Lan Connector	2-14
PS/2 Keyboard and Mouse Connector	2-16
Front and Rear Universal Serial Bus Connectors	2-16
Serial Port Connectors	2-16
Video Graphics Accelerator Connector	2-16
Printer Connector	2-17
Audio I/O Jacks	2-17
GAME/MIDI Connector	2-18

Chapter 3 BIOS Setup

CMOS Setup Utility	3-1
Standard CMOS Setup	3-2
Advanced BIOS Features	3-4
Advanced Chipset Features	3-7
Integrated Peripherals	3-11
Power Management Setup	3-16
PnP/PCI Configurations	3-20
PC Health Status	3-22
Frequency/Voltage Control	3-23
Load Fail-Safe Defaults	3-24
Load Optimized Defaults	3-24
Supervisor/User Password	3-24
Save and Exit Setup	3-25
Exit without Saving	3-26

Overview

The Micro ATX, Socket A 1stMainboard AE31 supports both the latest generation AMD® processors. AMD's new super fast Athlon™ processors achieve 1.1GHz being supported with AMD Athlon bus for double data rate transfers at 100 MHz for an effective 200 MHz transfer rate.

The 1stMainboard AE31 is built around the new VIA Apollo KLE133 (VT8361+686B) chipset supporting both DVD and AGP 1/2x, thus ensuring photo-realistic 3D. Onboard AC97 sound ensures high quality audio*, while providing the option of being disabled through the BIOS. Support for the Ultra DMA/100 protocol ensures for high data transfer speeds especially for long sequential transfers required by audio/visual applications. With 2 DIMM there is up to 1 GB available SDRAM.

*** The Audio features of this mainboard do not have an amplifier, an active speaker is a must.**

The mainboard also comes equipped with the new NOVUS range of innovative features that assist in the installation and maintenance. The features include *Easy Key*, which provides instant keyboard access to the BIOS for adjustments to Clock and Default settings and *LogoGenie*, which allows you to create your own customized logo to be displayed during system boot up. The *BIOS Guardian* is an Anti Virus utility that prevents viruses from damaging your system BIOS and rendering your system inoperative.

Expansion is provided by 1 CNR, 1 ISA and 3 PCIs. I/O connections include 2 serial ports, 1 parallel port, 1 VGA port, 1 PS/2 mouse and keyboard connector, 4 USB connectors and 1 media connector (Line-In, Line-Out, Mic-In, Game/Midi).

Package Checklist

If you discover any item below was damaged or lost, please contact your vendor.

- The mainboard
 - This user manual
 - One FDD cable
 - One HDD cable
 - One ATA/66 cable
 - Two software CDs (CD Pro, CD Plus)
- COM2 cable (optional)*
- Front Audio cable (optional)*
- USB cable with bracket on rear panel (optional) (FIC Part Number: 22-10753-01)*

IMPORTANT: AMD CPU HEAT SINK INSTALLATION



Be ware finish heat sink install. Before you boot system, please check the heat sink is complete contact with die of CPU.

The poor contact will bring about over heat, it may damage your processor.

It is strongly recommended that at least a 250-watt ATX power pupply be used for this motherboard. Make sure that your ATX power supply can supply at least 20 amperes on teh +5-Volt lead and 10mA on the +5-Volt standby lead (+5VSB). Your system may become unstable / unreliable and may experience difficulty in powering up if your power supply is inadequate.

The AE31 Mainboard

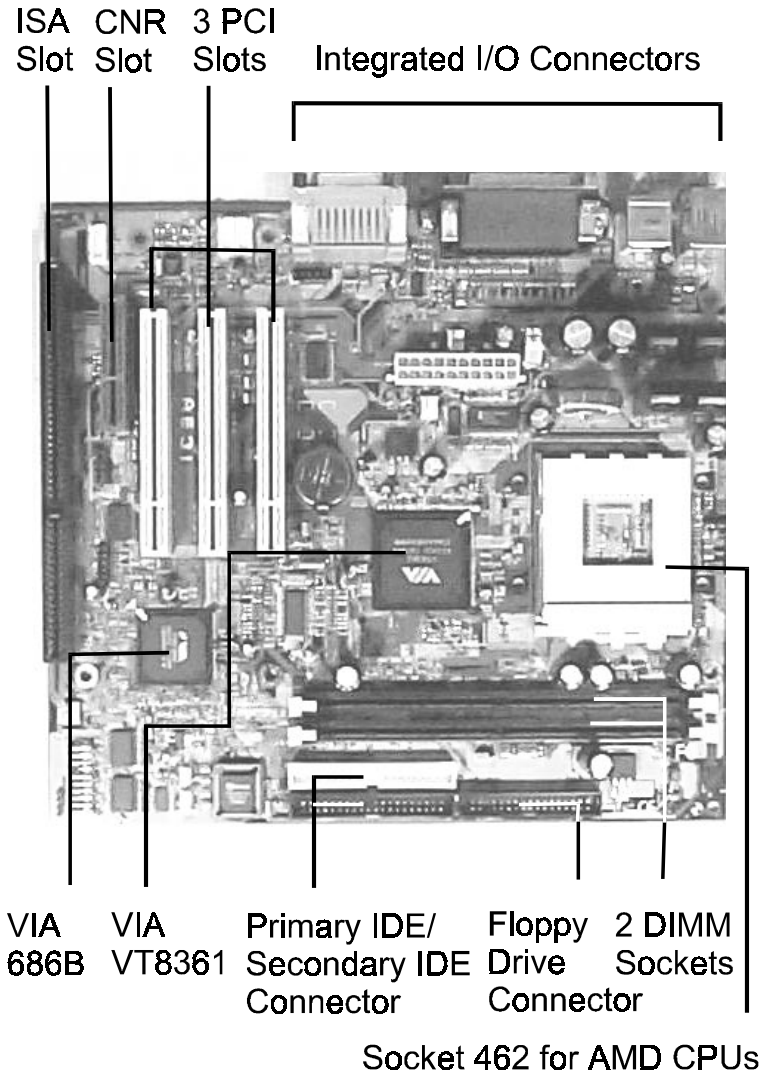

Chapter 1
Overview

Main Features

■ Easy Installation

BIOS with support for Plug and Play, auto detection of IDE hard drives, LS-120 drives, IDE ZIP drives, Windows 95, Windows 98/98SE, Windows ME, Windows NT, Windows 2000, and OS/2.

■ Leading Edge Chipset

VIA KLE133 (VT8361+686B) chipset provides integrated DRAM controllers with new Dynamic Power Management Architecture (DPMA), concurrent PCI AGP and USB spec. compliant . It offers integrated Trident graphics, DVD-capable multimedia (MPEG-2 & AC-3) accelerators

■ Advanced High Performance Memory Controller

Accepts up to 1GB DRAM using two DIMMs of 32, 64, 128, 256, 512MB with support for lightening-fast PC133 SDRAM.

■ Flexible Processor Support

AMD® Duron Socket 462 from 600MHz to 950MHz at 100 MHz FSB with AMD Duron bus for double data rate transfers in an effective 200 MHz transfer rate.

AMD® Athlon Socket 462 from 700MHz to 1.1GHz at 100 MHz FSB with AMD Athlon bus for double data rate transfers in an effective 200 MHz transfer rate.

■ Enhanced PCI Bus Master IDE Controller with Ultra DMA 33/66/100 Support

Integrated Enhanced PCI Bus Master IDE controller features two dual-channel connectors that up to four Enhanced IDE devices, including CD-ROM and Tape Backup Drives, as well as Hard Disk Drives supporting the new Ultra DMA 100 protocol. Standard PIO Mode 3, PIO Mode 4, DMA Mode 2, DMA Mode 4, UltraDMA-100 Mode 5 devices are also supported.

- **CNR, ISA and PCI Expansion Slots**

One CNR*, one ISA Bus expansion slot and three PCI Bus expansion slots provided the room to install a full range of add-on cards.

* **The CNR slot on this board does not support LAN function.**

- **Compact Onboard Audio Subsystem**

Embedded in VIA 686B, the audio processor offers mainly in the aspects of dual full-duplex Direct Sound channels, PCI master interface, standard AC97 (1.0/2.0) Codec interface, direct two game ports and one MIDI port interface, and complete software driver support for Windows 95/98/98SE/2000/ME/NT.

- **Super Multi Input/Output (I/O) Support**

Embedded in 686B, the features that included are dual full-duplex Direct Sound channels between system memory and AC97 link; PCI master interface with bursting capability; standard AC97 Codec interface (1.0/2.0); hardware SoundBlaster Pro for Windows DOS box and real-mode DOS legacy compatibility; plug and play with 4 IRQ, 4 DMA, and 4 I/O space options for SoundBlaster Pro and MIDI hardware.

- **Convenient Rear Panel USB Connection Support**

Two USB ports integrated in the rear I/O panel and two extra USB ports for either front or rear panel connection allow convenient and high-speed Plug and Play connections to the growing number of USB compliant peripheral devices on the market.

ACPI Ready

This mainboard fully implements the new ACPI (Advanced Configuration and Power Interface) 1.0 Hardware and BIOS requirement. If you install ACPI aware of operating system, such as Windows 98, you fully utilized the power saving under ACPI. (*Windows 2000/ME Professional supports ACPI functions.*)

FIC Unique Innovation for Users (NOVUS) - Enhanced Mainboard Features and System Support

■ LogoGenie

A user friendly GUI supporting Windows 95/98/98SE (not Windows 2000/NT/ME), LogoGenie allows you to customize, create or select a Logo which will be displayed when the system is booting.



NOTE:

1. LogoGenie supports Award BIOS only.
2. If you create a Logo file (.bmp) by LogoGenie, the file size must be 640 x 464 x 256 colors.

To enable this utility, please proceed as follows:

1. Insert CD Pro (4.2 or above). Select LogoGenie from the Menu and follow the installation instructions.
2. After LogoGenie has been installed, go to Windows Start Box. In Programs Menu, select LogoGenie 2.0, then select LogoGenie.
3. Press F1 to read Help file to understand how to use this software if it is new to you.

■ BIOS Guardian

BIOS Guardian by default is enabled. It must be disabled in order to reflash BIOS, thus effectively acts as a fire-wall against viruses that can attack the BIOS while the system is running.



WARNING: While execute Step3 below, please do not turn off the system power in order to avoid BIOS damage.

BIOS Guardian can be disabled as follows:

1. Go to BIOS Set Up Menu. (Press **Del** key while booting.)
2. Go to Advanced BIOS Features Set Up Submenu.
3. Disable BIOS Guardian.
4. Save the setting, and restart system.



NOTE: However, if it is disabled and while boot the system, the POST screen will be held and shows you the message to let you know the current status of BIOS Guardian. To press **G** key will enable the BIOS Guardian again; or simply to press the **space bar** will continue the booting process.

■ Easy Key

Instead of completing the multi-layered BIOS setup process these 3 Easy Key functions provide direct access to Sub-Menu's when completing BIOS settings adjustments.

Easy-Keys are as follows:

- Ctrl + c:** To enter clock settings menu.
- Ctrl + p:** To load Performance Default settings and restart.
- Ctrl + f:** To load Fail-Safe Default settings and restart.

This Page Left Blank for Note

Installation Procedures

The mainboard has several user-adjustable jumpers on the board that allow you to configure your system to suit your requirements. This chapter contains information on the various jumper settings on your mainboard.

To set up your computer, you must complete the following steps:

- Step 1 - Set system jumpers/switches
- Step 2 - Install memory modules
- Step 3 - Install the Central Processing Unit (CPU)
- Step 4 - Install expansion cards
- Step 5 - Connect ribbon cables, cabinet wires, and power supply
- Step 6 - Set up BIOS software
- Step 7 - Install supporting software tools



WARNING: Excessive torque may damage the mainboard. When using an electric screwdriver on the mainboard, make sure that the torque is set to the allowable range of 5.0 ~ 8.0kg/cm.

Mainboard components contain very delicate Integrated Circuit (IC) chips. To prevent static electricity from harming any of the mainboard's sensitive components, you should follow the following precautions whenever working on the computer:

1. Unplug the computer when working on the inside.
2. Hold components by the edges and try not to touch the IC chips, leads, or circuitry.
3. Wear an anti-static wrist strap which fits around the wrist.
4. Place components on a grounded anti-static pad or on the bag that came with the component whenever the components are separated from the system.

Quick Reference (from Page 2-2 to 2-4) Mainboard Layout

Chapter 2
Installation
Procedures

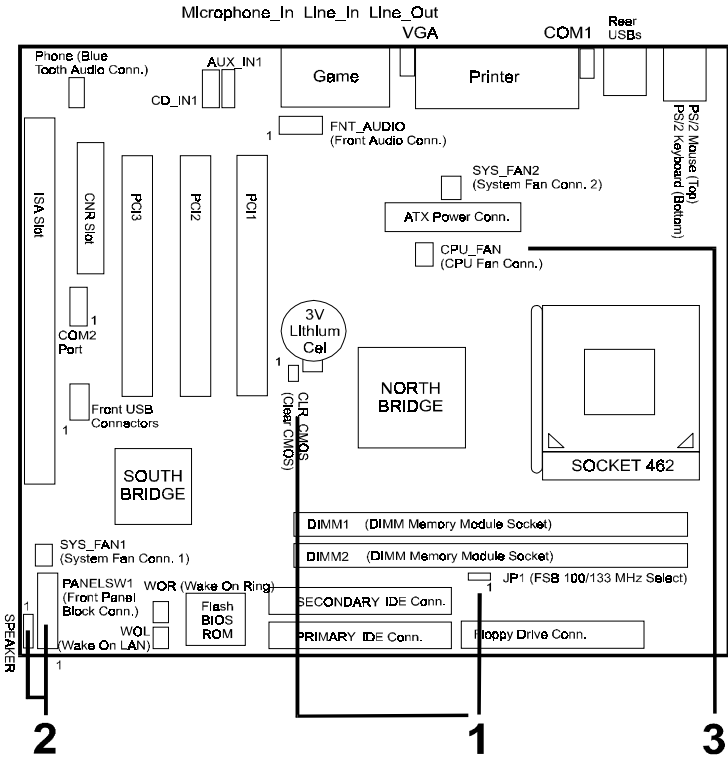

* Please use an active speaker with Line_Out jack.

1). Clear CMOS, FSB Select

Clear CMOS: CLR_CMOS



Normal
(Default)



Clear
CMOS

FSB Select: JP1

(For Future Upgrade, Users Are Not Encouraged to Change the Default Setting.)



133 MHz



100 MHz
(Default)

2). Front Panel Block Cable Connection

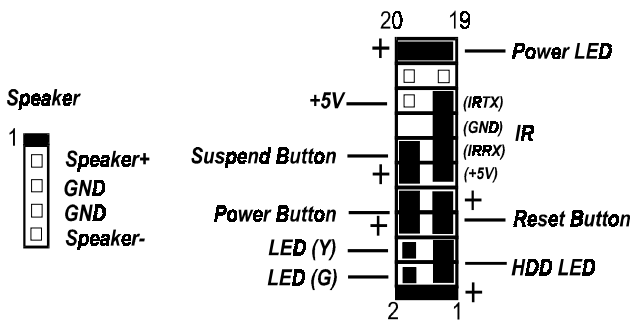

3). CPU Fan Installation

This connector is linked to the CPU fan. When the system is in power saving mode, the CPU fan will turn off; when it reverts back to full on mode, the fan will turn back on. Without sufficient air circulation, the CPU may overheat resulting in damage to both the CPU and the mainboard.

Damage may occur to the mainboard and/or the CPU fan if these pins are used incorrectly. These are not jumpers, do not place jumper caps over these pins.

1). Set System Jumpers

Jumpers are used to select the operation modes for your system. Some jumpers on the board have three metal pins with each pin representing a different function. A “1” is written besides pin 1 on jumpers with three pins. To **set** a jumper, a black cap containing metal contacts is placed over the jumper pin/s according to the required configuration. A jumper is said to be **shorted** when the black cap has been placed on one or two of its pins.



NOTE: Users are not encouraged to change the jumper settings not listed in this manual. Changing the jumper settings improperly may adversely affect system performance.

Clear CMOS: CLR_CMOS

The CMOS RAM is powered by the onboard button cell battery. To clear the RTC data: (1). Turn off your computer, (2). Move the jumper to CLEAR, (3). Move the jumper back to NORMAL, (4). Turn on your computer, (5). Hold down the <Delete> key during bootup and enter BIOS Setup to re-enter user preferences. **However, if the pin cap keeps staying at pin pair 2-3, the system can not boot up.**

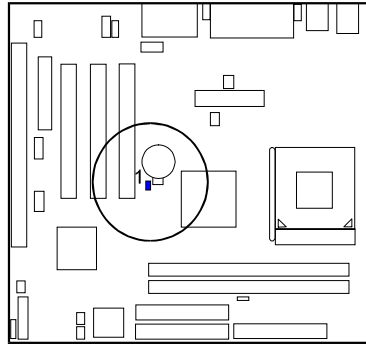
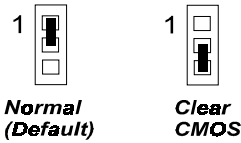

***FSB Speed Select: JPI
(for Future Upgrade)***

The jumper is for future upgrade use. Users are not encouraged to change its default setting.

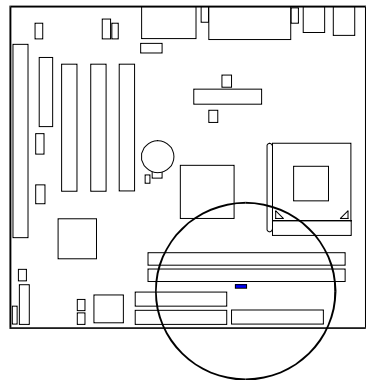
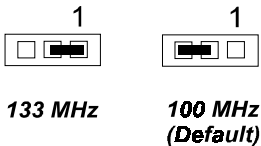

2). Install Memory Modules

1. Locate the DIMM slots on the mainboard.
2. Install the DIMM straight down into the DIMM slot using both hands.
3. The clip on both ends of the DIMM slot will close up to hold the DIMM in place when the DIMM reaches the slot's bottom.

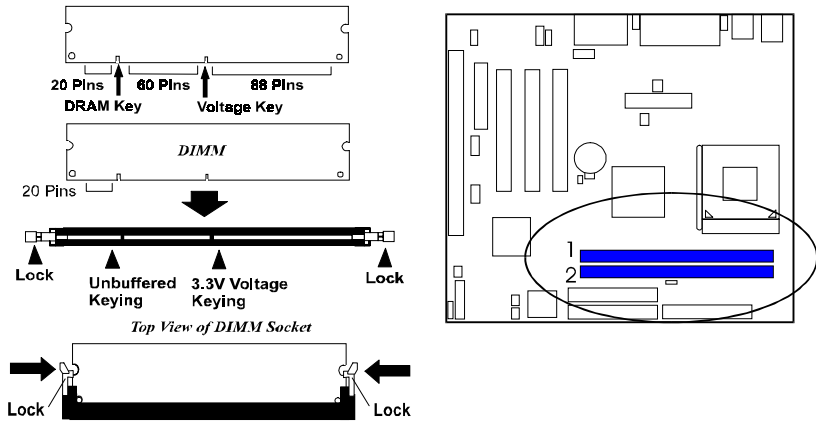

Press the clips with both hands to remove the DIMM.

3). Install the CPU

The mainboard has built-in Switching Voltage Regulator to support CPU Vcore autodetection. That is, It has the ability to detect and recognize the CPU voltage, clock, ratio and enables users to set up the CPU frequency from the BIOS Setup Screen. Users can adjust the frequency through “Frequency / Voltage Control” of the BIOS Setup Screen.

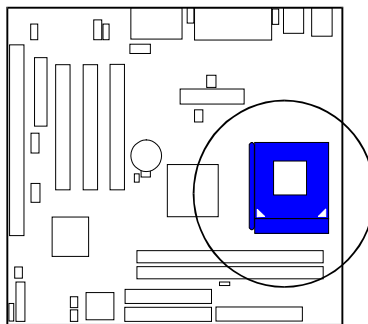



CAUTION:

1. The heatsink and fan you installed must be approved by CPU manufactories.
2. The mainboard must be placed on a solid place to avoid shaking while install the heatsink and fan on the board.
3. The heatsink must be contact with the CPU top tightly.
4. Never run the processor without the heatsink properly and firmly attached. PERMANENT DAMAGE WILL RESULT!

To install the CPU, do the following:

1. Lift the lever on the side of the CPU socket.
2. Handle the chip by its edges and try not to touch any of the pins.
3. Place the CPU in the socket. The chip has two notches to correctly locate the chip. Align two notches of the processor with the two triangular marks on the socket. Do not force the chip. The CPU should slide easily into the socket.
4. Swing the lever to the down position to lock the CPU in place.
5. Install the cooling fan with heatsink on top of the installed CPU.
6. Place the mainboard (with the CPU, its cooling fan, and heatsink) into the system chassis and affix it with screws.

4). Install Expansion Cards

This section describes how to connect an expansion card to one of your system's expansion slots. Expansion cards are printed circuit boards that, when connected to the mainboard, increase the capabilities of your system. For example, expansion cards can provide video and sound capabilities. The mainboard features one CNR*, one ISA, and three PCI bus expansion slots.

*** The CNR slot on this board does not support LAN function.**

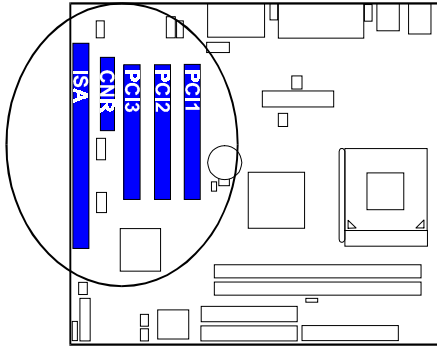

CAUTION: Make sure to unplug the power supply when adding or removing expansion cards or other system components. Failure to do so may cause severe damage to both the mainboard and expansion cards. Always observe static electricity precautions. Please read “Handling Precautions” at the start of this manual.

To install an expansion card, follow the steps below:

1. Remove the computer chassis cover and select an empty expansion slot.
2. Remove the corresponding slot cover from the computer chassis. Unscrew the mounting screw that secures the slot cover and pull the slot cover out from the computer chassis. Keep the slot cover mounting screw nearby.
3. Holding the edge of the peripheral card, carefully align the edge connector with the expansion slot.
4. Push the card firmly into the slot. Push down on one end of the expansion card, then the other. Use this “rocking” motion until the add-on card is firmly seated inside the expansion slot.

5. Secure the board with the mounting screw removed in Step 2. Make sure that the card has been placed evenly and completely into the expansion slot.
6. Replace the computer system's cover.
7. Setup the BIOS if necessary.
8. Install the necessary software drivers for the expansion card.

5). Connect Devices

Floppy Diskette Drive Connector

This connector provides the connection with your floppy disk drive. The red stripe of the ribbon cable must be the same side with the Pin 1.

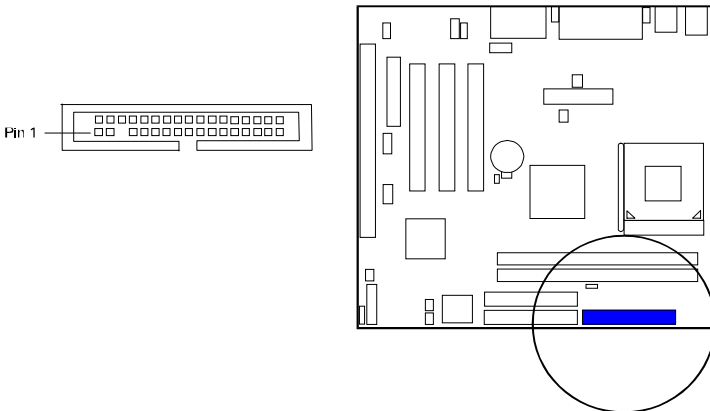

Fan Connectors

These connectors are linked to the CPU fan, case fan, and chip fan. For preventing system, chip, and CPU from overheat damage, the fans on this board keep running when the system in suspend mode.

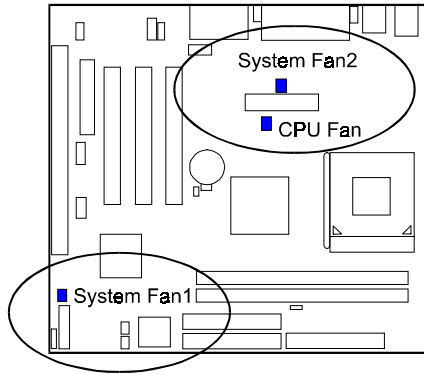
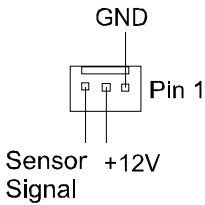

**Chapter 2
Installation
Procedures**

CD Audio-In Connectors

The two connectors are used for different types for CD drive audio in port.

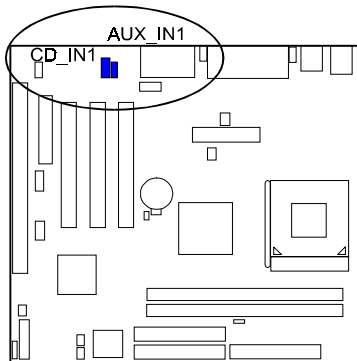
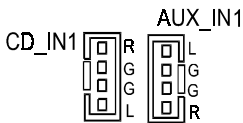

Front Panel Block and Speaker onnector

This block connector includes the connectors for linking with IDE LED, power LED, dual power LED, power button, sleep button, reset button and speaker on the front panel of the system case. Please identify polarities of plug wires for the case speaker and LEDs. Please ask vendor about this information when you buy them and install the system by yourself. The plug wires polarities of these buttons will not affect the function.

Chapter 2
Installation
Procedures

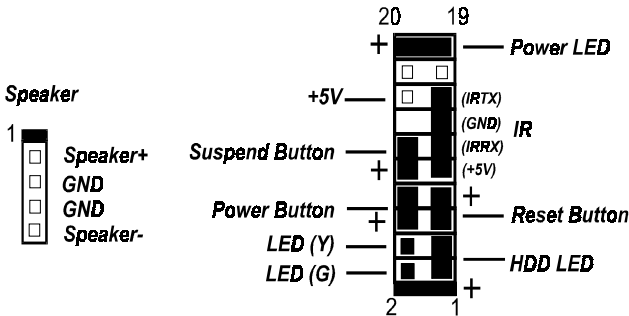
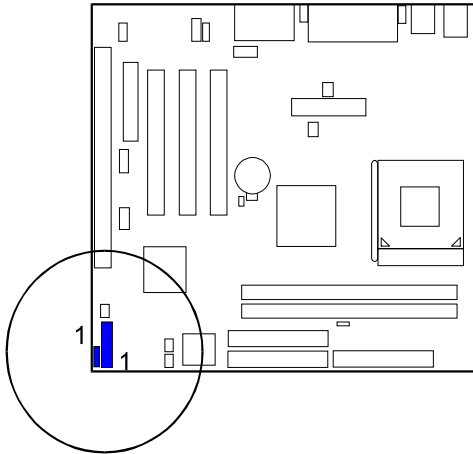

Power LED is connected with the system power indicator to indicate whether the system is on/off. It will blink when the system enters suspend mode.

IR is used to communicate with another IR device via a 4-wire plug.

Reset Button is connected to the reset button. Push this switch to reboot the system instead of turning the power button off and on.

HDD LED is connected to the IDE device indicator. This LED will blink when the hard disk drives are activated.

LED(G) is in green light when the system in power on status.

LED(Y) is in yellow light when the system in suspend mode.

Power Button is connected with power button. Push this switch allows the system to be turned on and off rather than using the power supply button.

Speaker is connected with the case speaker.

Blue Tooth Audio Port Connector

The 4-pin connector allows you to link to an optional FIC-produced metal bracket with Blue Tooth audio port.

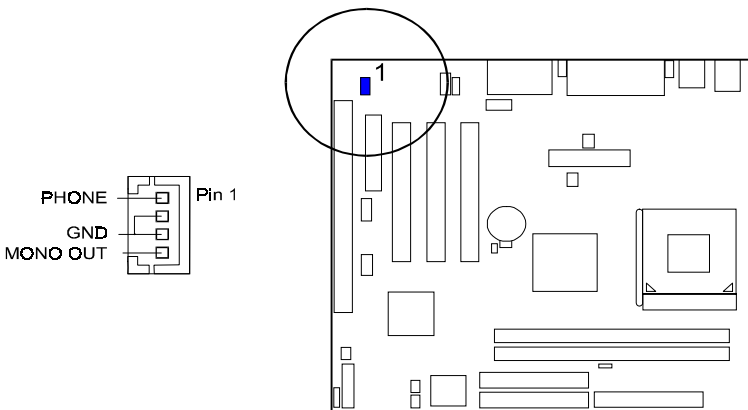

Wake-On-Ring Connector

This 2-pin connector allows the modem ring call to wake up your computer system by connecting a wire between this connector and your modem card that installed on the CNR slot.

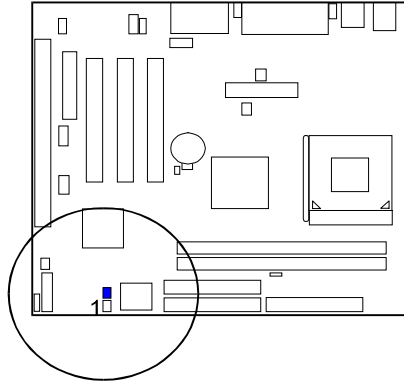
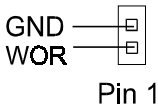

Wake-On-Lan Connector

This 3-pin connector allows the remote servers to manage the system that installed this mainboard via your network adapter which also supports WOL. When you install such a LAN card, please read its installation guide for more information.

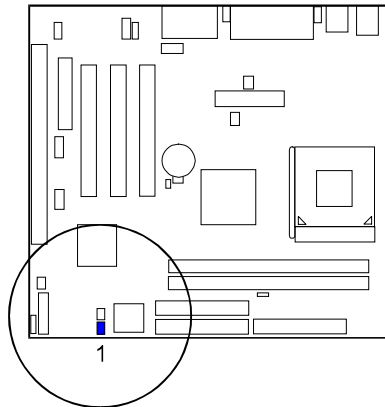
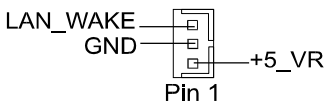

PS/2 Keyboard and Mouse Connector

These two 6-pin female (PS/2 keyboard is purple color and PS/2 mouse is green color) connectors are used for your PS/2 keyboard and PS/2 mouse.

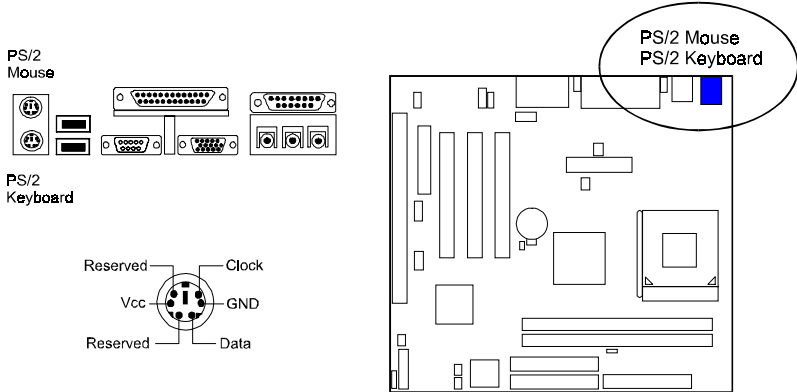

Front and Rear Universal Serial Bus Connectors

These two black connectors integrated on the edge of the board are used for linking with USB peripheral devices. This board also provides a front USB connector for linking with the two USB sockets on the front panel of some system cases. Please note your operating system must support USB features, such as MS Windows 95 OSR2.5 or later.

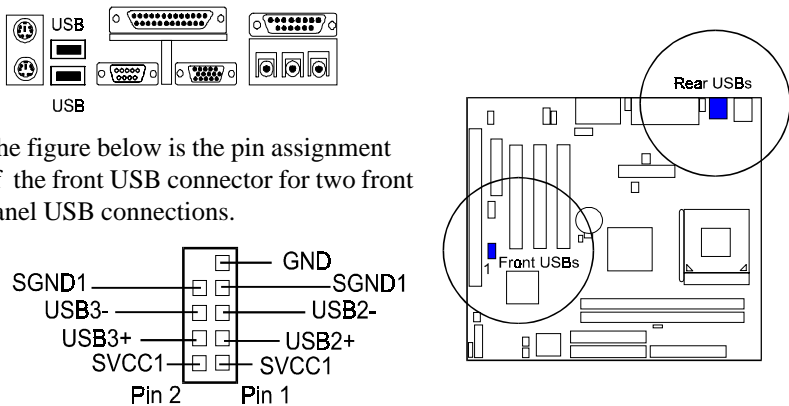

The figure below is the pin assignment of the front USB connector for two front panel USB connections.

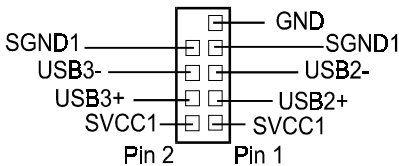

Serial Port Connectors

COM1 (9-pin D-sub male connector with teal color) and COM2 (9-pin male connector) allow you to connect with your devices that use serial ports, such as a serial mouse or an external modem.

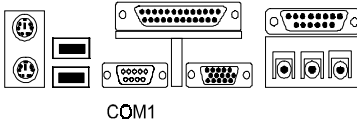

Pin 8: RI		Pin 9: GND
Pin 6: CTS		Pin 7: DTR
Pin 4: RTS		Pin 5: TXD
Pin 2: DSR	2	Pin 3: RXD
	1	Pin 1: DCD

COM2 Port

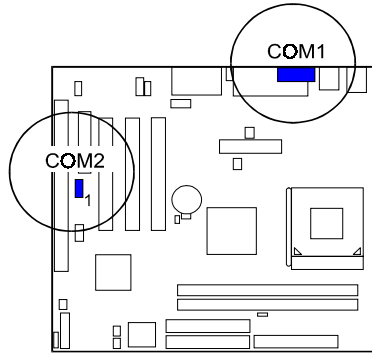

Video Graphics Accelerator Connector

This 15-pin female D-sub blue connector is connected to your display monitor.

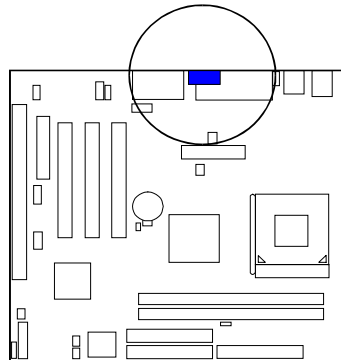
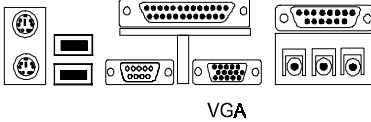

Printer Connector

This 25-pin D-Sub female burgundy-colored connector is attached to your printer.

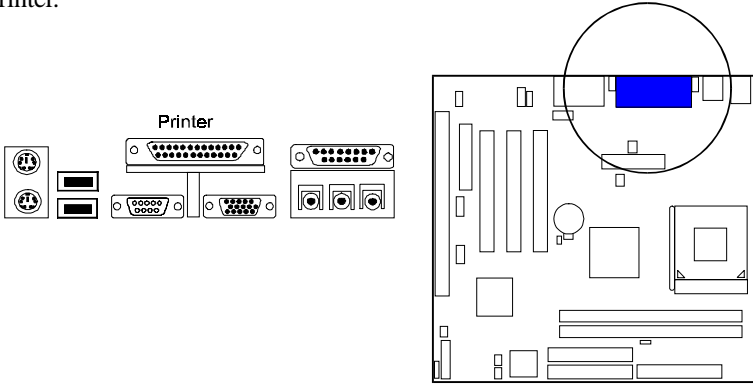

Chapter 2
Installation
Procedures

Audio I/O Jacks

LINE_OUT* (lime) can be connected to powered speakers. LINE_IN (light blue) allows tape players or other audio sources to be recorded by your computer. MIC_IN (pink) allows microphones to be connected for voice input. The mainboard also provides you with a front panel audio port connector, FNT_AUDIO, when needed. Its pin definitions were presented below.

* Please use an active speaker with LINE_OUT.

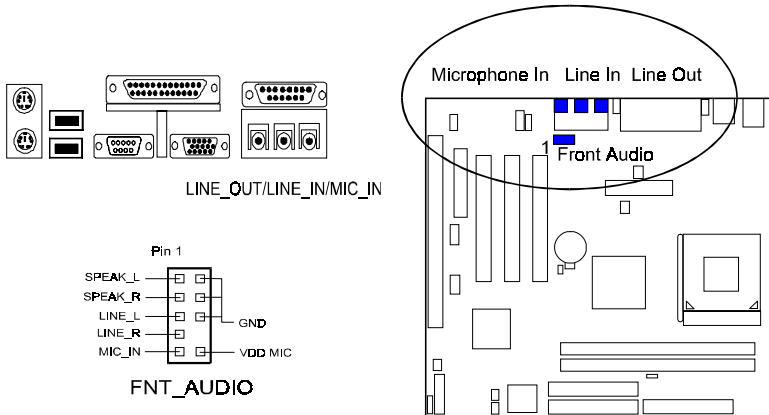

Game/MIDI Connector

This 15-pin female gold-colored connector allows you to connect game joysticks or game pads. Connect MIDI devices for playing or editing audio.

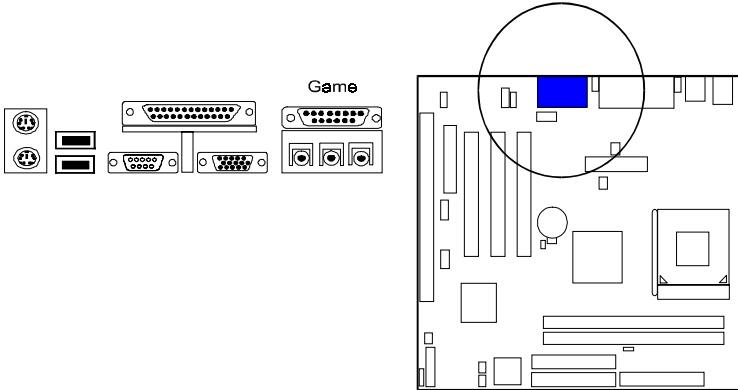

BIOS Setup

The mainboard comes with the chip that Award BIOS that contains the ROM Setup information of your system. (This chip serves as an interface between the processor and the rest of the mainboard's components.) This section explains the information contained in the Setup program and tells you how to modify the settings according to your system configuration.

CMOS Setup Utility

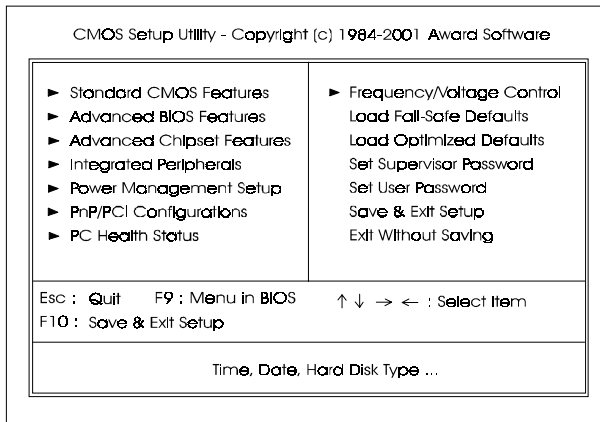

A Setup program, built into the system BIOS, the settings are stored in the CMOS. This Setup utility program allows updates to the mainboard configuration settings. It is executed when the user changes system configuration; user changes system backup battery; or the system detects a configuration error and asks the user to run the Setup program. Use the arrow keys to select and press **Enter** to run the selected program.

Standard CMOS Setup

CMOS Setup Utility - Copyright (c) 1984-2001 Award Software
Standard CMOS Features

		Item Help
Date (mm:dd:yy)	Tue, May 6 2001	Menu Level ► Change the day, month, year and century
Time (hh:mm:ss)	18 : 3 : 57	
► IDE Primary Master		
► IDE Primary Slave		
► IDE Secondary Master		
► IDE Secondary Slave		
Drive A	[1.44M, 3.5 in.]	
Drive B	[None]	
Floppy 3 Mode Support	[Disabled]	
Video	[EGA/VGA]	
Halt On	[All Errors]	
Base Memory	640K	
Extended Memory	48128K	
Total Memory	49152K	
↑↓ → Move Enter ; Select +/-/PU/PD; Value F10 ; Save ESC ; Exit F1 ; General Help F5 ; Previous Values F6 ; Fail-Safe Defaults F7 ; Optimized Defaults		

The Standard CMOS Setup screen is displayed above. Each item may have one or more option settings. The system BIOS automatically detects memory size, thus no changes are necessary. Use the arrow keys to highlight the item and then use **PgUp** or **PgDn** keys to select the value you want in each item.

Date

To set the date, highlight the *Date* field and then press **Page Up/Page Down** or +/- keys to set the current date. Follow the month, day and year format.

Time

To set the time, highlight the *Time* field and then press **Page Up/Page Down** or +/- keys to set the current time. Follow the hour, minute, and second format.

Hard Disks

This field records the specifications for all non-SCSI hard drives installed in the system. The onboard PCI IDE connectors provide Primary and Secondary channels for connecting up to four IDE hard disks or other IDE devices. Each channel can support up to two hard disks, the first of which is the *Master* and the second is the *Slave*.

Hard Disk Configurations

Capacity:	The hard disk size. The unit is Bytes.
Cylinder:	The cylinder number of the hard disk.
Head:	The read/write head number of hard disk.
Precomp:	The cylinder number at which the disk drive changes the write current.
Landing Zone:	The cylinder number that the disk drive heads (read/write) are seated when the disk drive is parked.
Sector:	The sector number of each track defined on the hard disk.

Drive A / Drive B

This field records the types of floppy drives installed in the system. To enter the configuration value for a particular drive, highlight its corresponding field and then select the drive type using the **Page Up** or **Page Down** key.

Floppy 3 Mode Support

This is a Japanese standard floppy type drive. The standard stores 1.2MB in a 3.5 inch diskette.

Video

Set this field to the type of video display card installed in the system.

Halt On

This field determines which types of errors will cause the system to halt.

Advanced BIOS Features

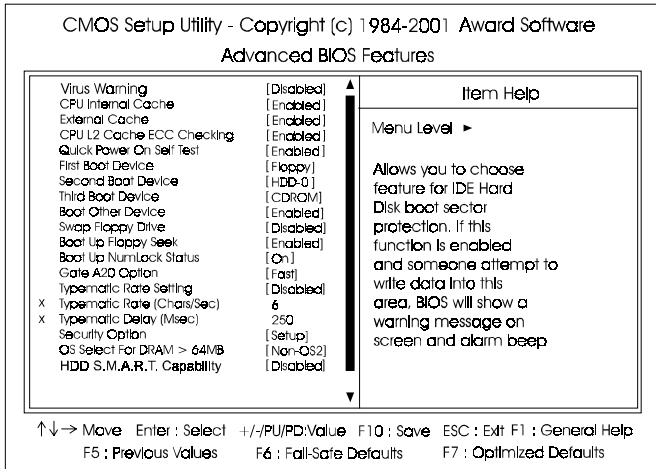

Virus Warning

This feature will prompt uses a warning message, when any write boot sector commend executed.

The options are: Enabled, Disabled.

CPU Internal Cache

When enabled, improves the system performance. Disable this item when testing or trouble-shooting. The options are: Enabled, Disabled.

External Cache

When enabled, supports CPU L2 cache. This feature allows you to disable the cache function when the system performance is unstable to run some software. The options are: Enabled, Disabled.

CPU L2 Cache ECC Checking

When enabled, it activates the CPU L2 cache check and error correction. The options are: Enabled, Disabled.

Quick Power On Self Test

When enabled, allows the BIOS to bypass the extensive memory test. The options are: Enabled, Disabled.

First Boot Device

This feature allows user to select the boot device priority. The options are: Floppy, LS120, HDD-0, SCSI, CDROM, HDD-1, HDD-2, HDD-3, ZIP100, USB-FDD, USB-ZIP, USB-CDROM, USB-HDD, LAN, Disabled.

Second Boot Device

This feature allows user to select the boot device priority. The options are: Floppy, LS120, HDD-0, SCSI, CDROM, HDD-1, HDD-2, HDD-3, ZIP100, USB-FDD, USB-ZIP, USB-CDROM, USB-HDD, LAN, Disabled.

Third Boot Device

This feature allows user to select the boot device priority. The options are: Floppy, LS120, HDD-0, SCSI, CDROM, HDD-1, HDD-2, HDD-3, ZIP100, USB-FDD, USB-ZIP, USB-CDROM, USB-HDD, LAN, Disabled.

Boot Other Device

This feature allows user to select the boot device priority. The options are: Enabled, Disabled.

Swap Floppy Drive

Allows you to switch the order in which the operating system accesses the floppy drives.

The options are: Enabled, Disabled.

Boot Up Floppy Seek

When enabled, assigns the BIOS to perform floppy diskette drive tests by issuing the time-consuming seek commands.

The options are: Enabled, Disabled.

Boot Up Numlock Status

When set to On, allows the BIOS to automatically enable the Num Lock Function when the system boots up. The options are: On, Off.

Gate A20 Option

When set at Fast, allows a faster access response of address Line No. 20. The options are: Fast, Normal.

Typematic Rate Setting

The term typematic means that when a keyboard key is held down, the character is repeatedly entered until the key is released.

The options are: Disabled, Enabled.

Typematic Rate (Chars/Sec)

This feature is available only if the above item, Typematic Rate Setting, is set at Enabled. Sets the rate of a character repeat when the key is held down. The options are: 6, 8, 10, 12, 15, 20, 24, 30.

Typematic Delay (Msec)

This feature is available only if the item, Typematic Rate Setting, is set at Enabled. Sets the delay time before a character is repeated.

The options are: 250, 500, 750, 1000 millisecond.

Security Option

Allows you to set the security level of the system.

The options are: Setup, System.

OS Select For DRAM > 64MB

If your operating system (OS) is OS/2, select the option OS2. Otherwise, stay with the default setting Non-OS2.

The options are: Non-OS2, OS2.

HDD S.M.A.R.T. Capability

S.M.A.R.T. stands for Self-Monitoring and Analysis Reporting Technology which allows your hard disk drive to report any read/write errors and issues a warning with LDCM installed.

The options are: Disabled, Enabled.

Report No FDD For WIN 95

When the field under the Standard CMOS Setup Menu for Drive A and/or Drive B is set at None, users must set this field is set at Yes for it to function properly. Otherwise, set at No, even if field for Drive A and/or Drive B is set at None, system will still detect and recognize of a floppy drive(s).

The options are: Yes, No.

BIOS Guardian

It allows the system to prevent computer viruses. Users will need to disable it to update BIOS. The options are: Enabled, Disabled.



NOTE: Please disable this BIOS feature about BIOS Guardian before you start to reflash BIOS.

Advanced Chipset Features

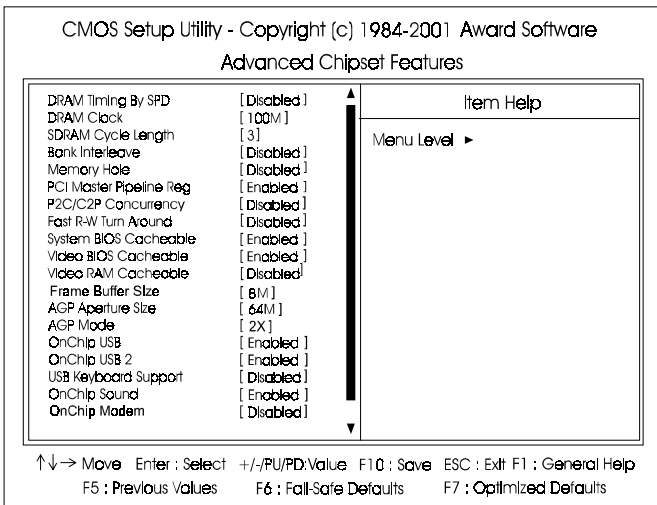

DRAM Timing By SPD

This item allows you to use supports of Serial Presence Detect (SPD), the system BIOS can recognize its specificity, then do automatic timer setting SPD data. If you set any timing manually, please set this feature at Disabled. The options are: Enabled, Disabled.

DRAM Clock

The feature allows users to select the DRAM clock.
The options are: 100MHz, 133MHz.

SDRAM Cycle Length

This item will function only when SDRAM DIMM/s are installed on the mainboard (BIOS auto detection). If the CAS latency of your SDRAM DIMM is 2, set it at 2 to enhance your system performance. If the CAS latency of your SDRAM DIMM is 3, stay with the default setting, 3. The options are: 3, 2.

Bank Interleave

This item allows users to select the bank interleave function of DRAM, when the feature DRAM Timing By SPD set at Disabled. The options are: Disabled, 2 Bank, 4 Bank.

Memory Hole

When you install a Legacy ISA card, this feature allows you to select the memory hole's address range of the ISA cycle when the processor accesses the selected address area. Please read your card manual for detail information. When disabled, the memory hole at the (15-16MB) address will be treated as a DRAM cycle when the processor accesses the 15~16MB address area. The options are: 15M - 16M, Disabled.

PCI Master Pipeline Req

This feature allows users to disable PCI master device pipeline controller request when necessary. The options are: Enabled, Disabled.

P2C/C2P Concurrency

This feature allows users to set PCI/AGP Master-to-CPU/ CPU-to-PCI/ AGP Slave concurrent. The options are: Enabled, Disabled.

Fast R-W Turn Around

It allows users to set DRAM fast read-to-write turn around. The options are: Enabled, Disabled.

System BIOS Cacheable

When enabled, allows the ROM area F000H-FFFFH to be cacheable when cache controller is activated. The options are: Enabled, Disabled.

Video BIOS Cacheable

As with caching the system BIOS above, enabling the video BIOS cache will cause access to the video BIOS addressed at C0000H-C7FFFH to be cached, if the cache controller is also enabled.

The options are Enabled, Disabled.

Video RAM Cacheable

When enabled, allows the video RAM area to be cacheable.

The options are: Enabled, Disabled.

Frame Buffer Size

It allows user to select the frame buffer size of VGA share memory.

The options are NA, 8M.

AGP Aperture Size

It allows you to select the main memory frame size for AGP use.

The options are 4M, 8M, 16M, 32M, 64M, 128M.

AGP Mode

This feature allows user to select onboard AGP mode to be 1X or 2X.

The options are: 1X, 2X.

OnChip USB/OnChip USB 2

When enabled, this feature allows you to use the onboard USB feature.

The options are: Enabled, Disabled.

USB Keyboard Support

This feature will appear only if the above item Onchip USB is set at Enabled. Set this feature to Enabled to use a USB keyboard with your system.

The options are: Disabled, Enabled.

OnChip Sound

This feature allows you to disable the onboard audio function if needed.

The options are: Auto, Disable.

OnChip Modem

This feature allows you to disable the CNR modem function if needed. The options are: Auto, Disable.

CPU to PCI Write Buffer

When enabled, allows data and address access to the internal buffer of the system controller; so the processor can be released from the waiting state. The options are: Enabled, Disabled.

PCI Dynamic Bursting

When enabled, the PCI controller allows Bursting PCI transfer if the consecutive PCI cycles come with the address falling in same 1KB space. This improves the PCI bus throughput.

The options are: Enabled, Disabled.

PCI Master 0 WS Write

When enabled, allows a zero-wait-state-cycle delay when the PCI master drive writes data to DRAM. The options are: Enabled, Disabled.

PCI Delay Transaction

Enable this feature to abort the current CPI master cycle and to accept the new PCI master request, it reaccepts the original PCI master and returns the PCI data phase to the original PCI master.

The options are: Disabled, Enabled.

PCI#2 Access #1 Retry

When enabled, the AGP (PCI#2) access to PCI (PCI#1) will be retried until the maximum count. The options are: Disabled, Enabled.

AGP Master 1 WS Write

When enabled, the AGP bus master write access to DRAMs will add one wait-state cycle. The options are: Enabled, Disabled.

AGP Master 1 WS Read

When enabled, the AGP bus master read access to the DRAMs will add one wait-state cycle. The options are: Disabled, Enabled.

Integrated Peripherals

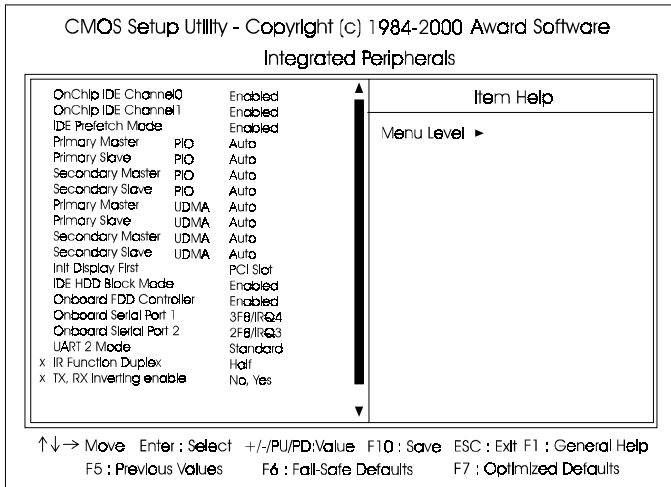

OnChip IDE Channel0

When enabled, allows you to use the onboard primary PCI IDE. If a hard disk controller card is used, set at Disabled.

The options are: Enabled, Disabled.

OnChip IDE Channel1

When enabled, allows you to use the onboard secondary PCI IDE. If a hard disk controller card is used, set at Disabled.

The options are: Enabled, Disabled.

IDE Prefetch Mode

When set at Enabled, it allows data to be posted to and prefetched from the primary IDE data ports. Data prefetching is initiated when a data port read occurs. The read prefetch eliminates latency to the IDE data ports and allows them to be performed back to back for the highest possible PIO data transfer rates. The first data port read of a sector is called the demand read. Subsequent data port reads from the sector are called prefetch reads. The demand read and all prefetch reads must be of the same size (16 or 32 bits). The options are: Enabled, Disabled.

Primary Master PIO

Allows an automatic or a manual configuration of the PCI primary IDE hard disk (master) mode. The options are: Auto, Mode 0, Mode 1, Mode 2, Mode 3, Mode 4.

Primary Slave PIO

Allows an automatic or a manual configuration of the PCI primary IDE hard disk (slave) mode. The options are: Auto, Mode 0, Mode 1, Mode 2, Mode 3, Mode 4.

Secondary Master PIO

Allows an automatic or a manual configuration of the PCI secondary IDE hard disk (master) mode. The options are: Auto, Mode 0, Mode 1, Mode 2, Mode 3, Mode 4.

Secondary Slave PIO

Allows an automatic or a manual configuration of the PCI secondary IDE hard disk (slave) mode. The options are: Auto, Mode 0, Mode 1, Mode 2, Mode 3, Mode 4.

Primary Master UDMA

Allows you to select the first PCI IDE channel of the first master hard disk mode or to detect it by the BIOS if the hard disk supports UDMA (Ultra DMA, faster than DMA). The options are: Auto, Disable.

IDE Primary Slave UDMA

Allows you to select the first PCI IDE channel of the first slave hard disk mode or to detect it by the BIOS if the hard disk supports UDMA (Ultra DMA, faster than DMA). The options are: Auto, Disable.

IDE Secondary Master UDMA

Allows you to select the second PCI IDE channel of the secondary master hard disk mode or to detect it by the BIOS if the hard disk supports UDMA (Ultra DMA, faster than DMA). The options are: Auto, Disable.

IDE Secondary Slave UDMA

Allows you to select the second PCI IDE channel of the secondary slave hard disk mode or to detect it by the BIOS if the hard disk supports UDMA (Ultra DMA, faster than DMA). The options are: Auto, Disable.

Init Display First

When you install a PCI VGA card on the board, this feature allows you to select the first initiation of the monitor display from PCI or onboard AGP. The options are: PCI Slot, AGP.

IDE HDD Block Mode

When enabled, the system executes read/write requests to hard disk in block mode. The options are: Enabled, Disabled.

Onboard FDD Controller

When enabled, the floppy diskette drive (FDD) controller is activated. The options are: Enabled, Disabled.

Onboard Serial Port 1

If the serial port 1 uses the onboard I/O controller, you can modify your serial port parameters. If an I/O card needs to be installed, COM3 and COM4 may be needed. The options are: 3F8/IRQ4, 3E8/IRQ4, 2F8/IRQ3, 2E8/IRQ3, Disabled.

Onboard Serial Port 2

If the serial port 2 uses the onboard I/O controller, you can modify your serial port parameters. If an I/O card needs to be installed, COM3 and COM4 may be needed. The options are: 2F8/IRQ3, 3E8/IRQ4, 2E8/IRQ3, 3F8/IRQ4, Disabled.

UART 2 Mode

Select an operating mode for the second serial port. Set at Standard, if you use COM2 as the serial port as the serial port, instead as an IR port. The options are: Standard, ASK-IR, HPSIR.

IR Function Duplex

This feature is available only if the above item, UART2 Mode, is set at ASKIR or HPSIR. It allows you to select the infrared data transaction way. The options are: Half, Full.

TX, RX Inverting Enable

This feature is available only if the above item, UART2 Mode, is set at ASKIR or HPSIR. It allows you to select the active signals of the reception end and the transmission end.

The options are: No, Yes; Yes, Yes; No, No; Yes, No.

Onboard Parallel Port

Allows you to select from a given set of parameters if the parallel port uses the onboard I/O controller.

The options are: 378/IRQ7, 278/IRQ5, 3BC/IRQ7, Disabled.

Onboard Parallel Port Mode

Allows you to connect with an advanced printer.

The options are: Normal, EPP, ECP, ECP/ECP.

ECP Mode Use DMA

This feature allows you to select Direct Memory Access (DMA) channel if the ECP mode selected. The options are: 3, 1.

Parallel Port EPP Type

This feature allows you to select the EPP type for the parallel port.

The options are: EPP1.9, EPP1.7.

Onboard Legacy Audio

Set Audio to be compatible with legacy mode.

The options are: Enabled, Disabled.

Sound Blaster

This feature allows you to set audio to Sound Blaster mode, if the onboard Legacy audio chosen. The options are: Enabled, Disabled.

SB I/O Base Address

This feature allows you to select the SB I/O base address, if the onboard Legacy audio chosen. The options are: 220H, 240H, 260H, 280H.

SB IRQ Select

This feature allows you to select the SB IRQ, if the onboard Legacy audio chosen. The options are: IRQ 5, IRQ 7, IRQ 9, IRQ 10.

SB DMA Select

This feature allows you to select the SB DMA channel, if the onboard Legacy audio chosen.

The options are: DMA 1, DMA 2, DMA 3, DMA0.

MPU-401

This feature allows you to enable MPU-401, if the onboard Legacy audio chosen. The options are: Disabled, Enabled.

MPU-401 I/O Address

This feature allows you to select the MPU-401 I/O address, if the onboard Legacy audio chosen.

The options are: 310-313H, 320-323H, 330-333H, 300-303H.

Game Port (200-207H)

This feature allows you to select the game port (200-207H), if the onboard Legacy audio chosen.

The options are: Enabled, Disabled.

Power Management Setup

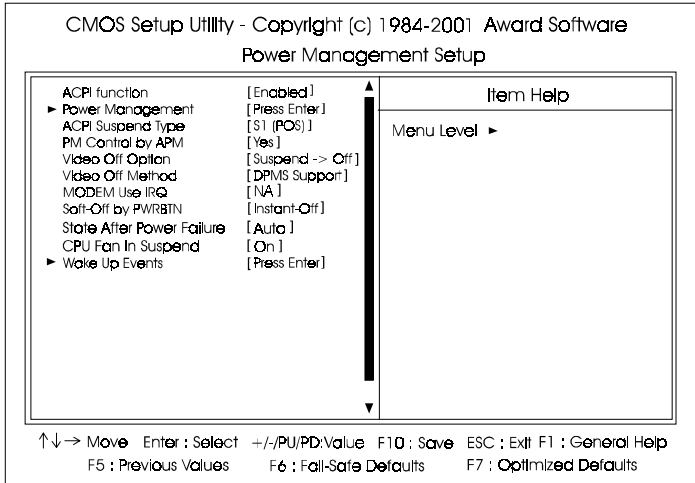

ACPI function

This item allows you to disable the ACPI function.
The options are: Enabled, Disabled.

Power Management

This item allows you to adjust the power management features.
Select User Define for configuring your own power management features.
Min Saving initiates all predefined timers in their minimum values. Max Saving, on the other hand, initiates maximum values. The options are: User Define, Min Saving, Max Saving.

HDD Power Down

The option lets the BIOS turn the HDD motor off when system is in Suspend mode. Selecting 1 Min..15 Min allows you define the HDD idle time before the HDD enters the Power Saving Mode.
The options 1 Min..15 Min will not work concurrently. When HDD is in the Power Saving Mode, any access to the HDD will wake the HDD up.
The options are: Disable, 1 Min..15 Min.

Doze Mode

When disabled, the system will not enter Doze mode. The specified time option defines the idle time the system takes before it enters Doze mode. The options are: Disable, 1, 2, 4, 6, 8, 10, 20, 30, 40 Min, 1 Hour.

Suspend Mode

When disabled, the system will not enter Suspend mode. The specified time option defines the idle time the system takes before it enters Suspend mode. The options are: Disable, 1, 2, 4, 6, 8, 10, 20, 30, 40 Min, 1 Hour.

ACPI Suspend Type

This item allows you to select ACPI suspend types. The options are: S1(POS), S3 (STR).

PM Control by APM

The option No allows the APM (Advanced Power Management) specification be ignored. Selecting Yes will allow the BIOS wait for APM's prompt before it enters Doze mode, Standby mode, or Suspend mode. If the APM is installed, it will prompt the BIOS to set the system into power saving mode when all tasks are done. The options are: No, Yes.

Video Off Option

This feature provides the selections of the video display power saving mode. The option Suspend - Off allows the video display to go blank if the system enters Suspend mode. The option All Modes - Off allows the video display to go blank if the system enters Doze mode or Suspend mode. The option Always On allows the video display to stay in Standby mode even when the system enters Doze or Suspend mode. The options are: Suspend - Off, All Modes -> Off, Always On.

Video Off Method

The option *V/H SYNC+Blank* allows the BIOS to blank off screen display by turning off the V-Sync and H-Sync signals sent from add-on VGA card. *DPMS Support* allows the BIOS to blank off screen display by your add-on VGA card which supports DPMS (Display Power Management Signaling function). *Blank Screen* allows the BIOS to blank off screen display by turning off the red-green-blue signals.

The options are: V/H SYNC+Blank, DPMS Support, Blank Screen.

MODEM Use IRQ

This feature allows you to select the IRQ# to meet your modem's IRQ#.

The options are: NA, 3, 4, 5, 7, 9, 10, 11.

Soft-Off by PWR-BTTN

The selection Delay 4 Sec. will allow the system shut down after 4 seconds after the power button is pressed. The selection Instant-Off will allow the system shut down immediately once the power button is pressed.

The settings are: Delay 4 Sec, Instant-Off.

State After Power Failure

The item allows you to select the state that your personal computer returns to after a power failure. If set at Off, the system will not boot after a power failure. If set On, the system will restart after power failure.

The settings are: Auto, On, Off.

CPU Fan In Suspend

The CPU fan keeps running when set at On to prevent the CPU from overheat. Setting Off will let the CPU Fan stop as the system enters S1 power saving mode. The options are: On, Off.

VGA

When set at On, any VGA activity will awake the system.

The options are: OFF, ON.

LPT & COM

When LPT/COM is selected, any access of LPT and COM ports will awake the system. Likewise, either LPT or COM is chosen, the system will be awoken by any activity of LPT or COM port.

The options are: LPT/COM, LPT, COM, NONE.

HDD & FDD

When it is set at ON, any access happened at hard drives and floppy drives will awake the system.

The options are: OFF, ON.

PCI Master

To set this feature at ON activates that Power Management feature (PM) wake-up event for the PCI bus master card.

The options are: OFF, ON.

Wake Up On LAN

When set at Enabled, an input signal comes from the other client/server on the LAN awakes the system from a soft off state if connected over LAN.

The options are Disabled or Enabled.

PowerOn by PCI Card

When set at Enabled, any PCI-PM event awakes the system from a PCI-PM controlled state.

The options are Disabled, Enabled.

Modem Ring Resume

An input signal on the serial Ring Indicator (RI) line (in other words, an incoming call on the modem) awakens the system from a soft off state.

The options are: Enabled, Disabled.

RTC Alarm Resume

Enabled allows you to set the time the system will be turned on from the system power-off status. The options are: Enabled, Disabled.

Date (of Month)

This feature allows you to set the day of the alarm starts when the RTC Alarm Resume From Soft Off is set to be Enabled. The options are: 0, 1..31.

Resume Time (hh:mm:ss)

If an ATX power supply is installed and when RTC Alarm Resume is Enabled, this feature allows you to set the time of the alarm starts when the RTC Alarm Resume From Soft Off is set to be Enabled.

The options are: 7: 0: 0. hh (*hour*) - 0, 1, 2,..., 23; mm (*minute*) - 0, 1, 2,...,59; ss (*second*) - 0, 1, 2,...,59.

IRQs Activity Monitoring

After the time period which you set, the system advances from doze mode to suspend mode in which the CPU clock stops and the screen display is off. At this moment, if the IRQ activity occurs, the system goes back to full-on mode directly.

If the IRQ activity which is defined as Non Primary takes place, the system remains off until the corresponding IRQ handler finishes.

The options of IRQ 3, 4, 5, 6, 7, 8, 9, 10, 11, 12, 13, 14, 15 are: Enabled, Disabled.

PnP/PCI Configurations

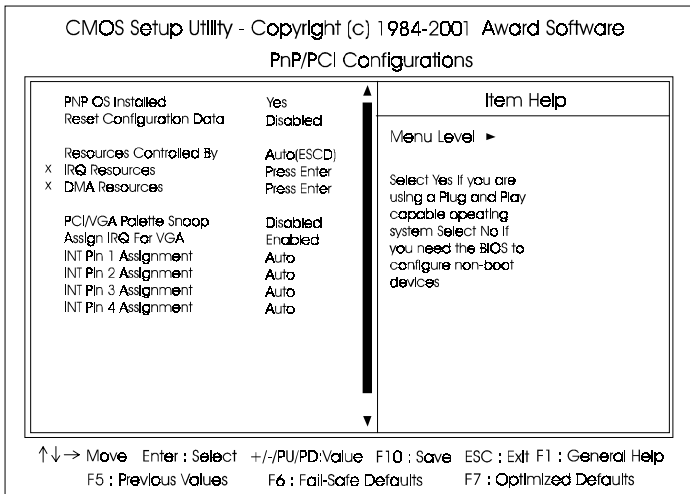

PNP OS Installed

If your operating system is a Plug-and-Play one, such as Windows NT, Windows 95, select Yes. The options are: No, Yes.

Reset Configuration Data

Enabling it to reset the system Extended System Configuration Data (ESCD) when you exit Setup if you have installed a new add-on card and the system reconfiguration has caused such a serious conflict that the operating system can not boot. The options are: Disabled, Enabled.

Resources Controlled By

If set at Auto, the BIOS arranges all system resources. If there exists conflict, select Manual. The options are: Auto (ESCD), Manual.

The manual options of **IRQ- /DMA-** assigned to are: PCI/ISA PnP, Legacy ISA.

PCI/VGA Palette Snoop

Set this feature to be enabled if any ISA adapter card installed in the system requires the VGA palette snoop function.

The options are: Disabled, Enabled.

Assign IRQ For VGA

If your PCI VGA card devices do not need an IRQ, select Disabled; therefore, an IRQ can be released for the system use.

The options are: Enabled, Disabled.

INT Pin 1/2/3/4 Assignment

This feature allows you to assign the PCI IRQ numbers for PCI slots. Selecting the default, Auto, allows the PCI controller to automatically allocate the IRQ numbers.

The options are: Auto, 3, 4, 5, 7, 9, 10, 11, 12, 14, 15.

PC Health Status

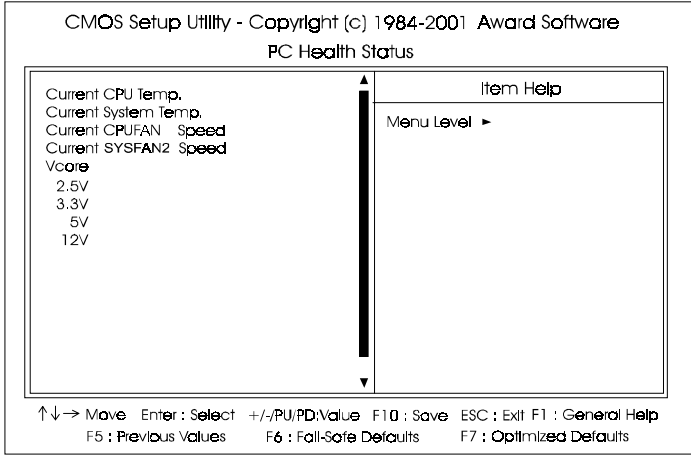

It allows you and technicians to monitor data provided by the BIOS on this mainboard. Some of them are not user-configurable.

Current CPU Temp. / Current System Temp. / Current CPUFAN Speed / Current SYSFAN2 Speed

These items allow end users and technicians to monitor data such as the current CPU temperature, CPU and case cooling fans rotating speed.

Frequency/Voltage Control

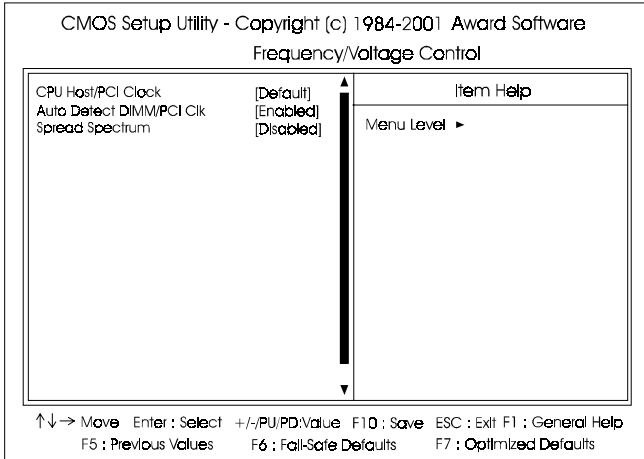

CPU Host/PCI Clock

This feature allows you to set the CPU/PCI clock frequency. The default setting, Default, will detect your CPU/PCI clock frequency automatically. If you set a unappropriate option which leads to a booting problem, keep pressing the Insert key until the display appears will solve it.

The option list offered all combinations that supported by this mainboard.

Auto Detect DIMM/PCI Clk

When enabled, BIOS will detect the PCI slot and DIMM slot. If no any device in, BIOS will auto disable its clock.

The options are: Enabled, Disabled.

Spread Spectrum

This feature is used to set the spread Spectrum to be center spread type or down spread type. The options are: Disabled, Enabled.

Load Fail-Safe Defaults

This submenu is selected to diagnose the problem after the computer boots, if the computer will not boot. These settings do not give optimal performance.

Load Optimized Defaults

This submenu is selected for default settings which provide the best system performance.

Supervisor/User Password

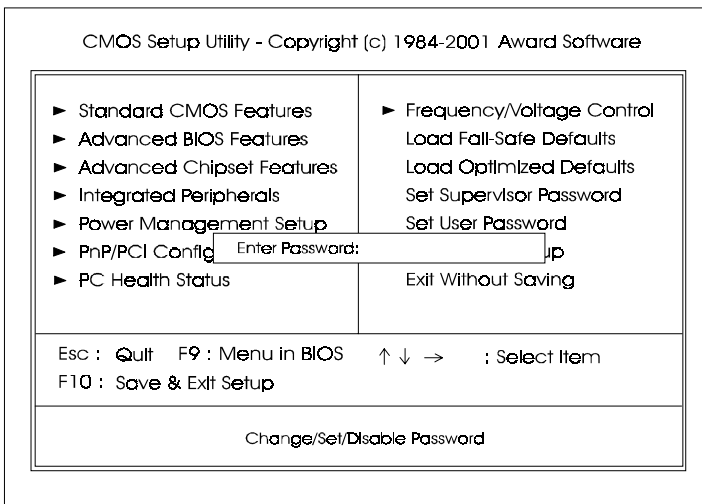

To enable the Supervisor/User passwords, select the item from the Standard CMOS Setup. You will be prompted to create your own password. Type your password up to eight characters and press Enter. You will be asked to confirm the password. Type the password again and press Enter. To disable password, press Enter twice when you are prompted to enter a password. A message appears, confirming the password is disabled.

Under the BIOS Feature Setup, if *Setup* is selected under the Security Option field and the Supervisor/User Password is enabled, you will be prompted password every time you try to enter the CMOS Setup Utility. If *System* is selected and the Supervisor/User Password is enabled, you will be requested to enter the Password every time when you reboot the system or enter the CMOS Setup utility.

Save and Exit Setup

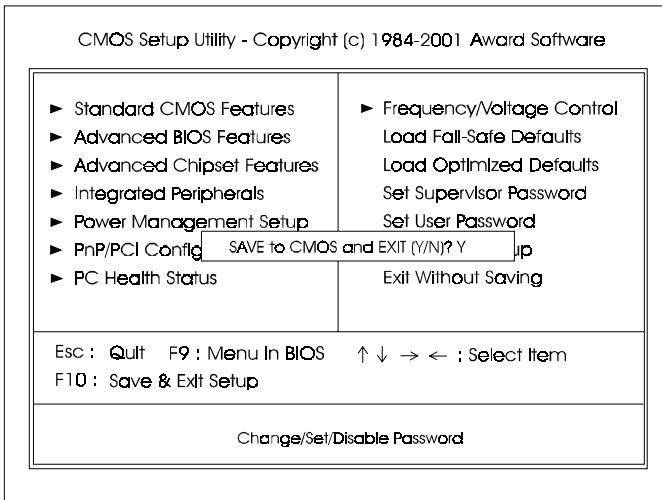

After you have made changes under Setup, press Esc to return to the main menu. Move cursor to Save and Exit Setup or press F10 and then press Y to change the CMOS Setup. If you did not change anything, press Esc again or move cursor to Exit Without Saving and press Y to retain the Setup settings. The following message will appear at the center of the screen to allow you to save data to CMOS and exit the setup utility: **SAVE to CMOS and EXIT (Y/N)?**

Exit without Saving

If you select this feature, the following message will appear at the center of the screen to allow you to exit the setup utility without saving CMOS modifications: **Quit Without Saving (Y/N)?**