

Pentium

**82430 VX/P54C PCI Mainboard
User's Guide &
Technical Reference
*5VD2/D5***

**SOYO**TM

About This Guide

This User's Guide is for assisting system manufacturers and end users in setting up and installing the mainboard. Information in this guide has been carefully checked for reliability; however, no guarantee is given as to the correctness of the contents. The information in this document is subject to change without notice.

Copyright Notice

Copyright 1997, Soyo Computer Inc. All rights reserved. This manual is copyrighted by Soyo Computer Inc. You may not reproduce, transmit, transcribe, store in a retrieval system, or translate into any language, in any form or by any means, electronic, mechanical, magnetic, optical, chemical, manual, or otherwise, any part of this publication without express written permission of Soyo Computer Inc.

Trademarks

Soyo is a registered trademark of Soyo Computer Inc. All trademarks are the property of their owners.

Disclaimer

Soyo Computer Inc. makes no representations or warranties regarding the contents of this manual. We reserve the right to revise the manual or make changes in the specifications of the product described within it at any time without notice and without obligation to notify any person of such revision or change. The information contained in this manual is provided for general use by our customers. Our customers should be aware that the personal computer field is the subject of many patents. Our customers should ensure that they take appropriate action so that their use of our products does not infringe upon any patents. It is the policy of Soyo Computer Inc. to respect the valid patent rights of third parties and not to infringe upon or assist others to infringe upon such rights.

Restricted Rights Legend

Use, duplication, or disclosure by the Government is subject to restrictions set forth in subparagraph (c)(1)(ii) of the Rights in Technical Data and Computer Software clause at 252.277-7013.

Product Rights

Product mentioned in this manual are mentioned for identification purpose only. Product names appearing in this manual may or may not be registered trademarks or copyrights of their respective companies.

If you need any further information, please come to our home page on internet. The address is "<http://www.soyo.com.tw>".

Edition: April 1997

Version 1.1

5VD2/D5 SERIAL

Table of Contents

Chapter 1: Introduction	1
Key Features	1
Unpacking the Mainboard	2
Electrostatic Discharge Precautions	2
Mainboard Layout w/ Default Settings	3
Chapter 2: Hardware Setup	5
Jumpers	5
JP5: CMOS Clear Jumper	5
JPS2: PS/2 Mouse Function Jumper	5
JP43: CPU Cooling Fan Connector	6
CPU Type Configuration	7
Step 1: Frequency Setting	7
Pentium – 75/90/100 CPU Settings (1.5 x clock)	7
Pentium – 100/120/133 CPU Settings (2.0 x clock)	8
Pentium/AMD – 150/166 CPU Settings (2.5 x clock)	9
Pentium – 180/200 CPU Settings (3.0 x clock)	9
Pentium – 233 CPU Settings (3.5 x clock)	10
Cyrix 6x86 – PR200+ CPU Settings (2.0 x clock)	10
Step 2: CPU Single/Dual Voltage Setting	11
Single Voltage CPU Setting	11
Dual Voltage CPU Setting	12
Memory Configuration	13
RAM Bank Installation Notice	13
Cache Configuration	13
Cache Size and RAM Locations	13
Multi I/O Port Addresses	14
Connectors	14
COM1, COM2– COM1/COM2 Connectors	14
FDC Connector	14
J19 – Hardware Reset Control	14
J24 – HDD LED Connectors	14
IDE1/IDE2 – On-board Primary/Secondary IDE HDD Connectors	15
IR1 – IR Connector	15
J2 – Keyboard Connector	15
J17 – Keylock & Power LED Connector	15
J1 – PS/2 Mouse Connector	15
PRT – Parallel Port Connector	15
PW – Power Supply Connector	15
J23: Sleep Switch Connector Enable/Disable	16

Connectors (Continued)	
J22 – Turbo LED Connector	16
USB1 – Universal Serial Bus Connectors	16

Chapter 3: BIOS Setup..... 17

Standard CMOS Setup	18
BIOS Features Setup	20
Chipset Features Setup	23
Power Management Setup	26
PNP/PCI Configuration Setup	28
Load Setup Defaults	30
Load BIOS Defaults	30
Integrated Peripherals	31
Supervisor Password	33
User Password	34
IDE HDD Auto Detection	35

Chapter 4: Drivers Installation Guide 36

IDE BUS Master Installation Guide	36
MS-DOS/WINDOW/WFW	36
WINDOWS NT3.5/4.0	36
WINDOWS 95	37
NOVELL 3.X&4.X	37
SCO UNIX	37
SCO UNIX 5.0	38
OS/2 2.0 and WARP 3.X	39

1 Introduction

The 82430 VX PCI mainboard is a high-performance **AT form-factor** system board that supports P54C/P55C family CPUs. You can order 256K or 512K of external cache memory on the mainboard. The mainboard is fully compatible with industry standards, and adds many technical enhancements.

Key Features

- CPU
 - Supports P54C/P55C family CPUs running at 75~233 MHz speeds; Cyrix 6x86/6x86L CPUs running at PR133+/PR150+/PR166+ speeds; and AMD K5/K6 CPUs running at PR75 ~ PR266 speeds
 - **Supports SOCKET 7 for upgrade**
 - Supports P54C/P55C series SMM Mode and CPU Stop Clock
- L2 Cache Controller
 - Write Back Cache Modes and Direct Mapped Organization
 - On-board 256K/512K Pipeline Burst SRAMs Cache
- DRAM Controller
 - Supports Fast-Page Mode, and EDO DRAM (both symmetrical and asymmetrical addressing)
 - **Supports 2 strips of 8MB/16MB/32MB Unbuffered DIMMs**
 - On-board memory configurations from **4 to 128 Mbytes**
 - Supports “**Table-Free**” DRAM configuration in any SIMM bank
- BUS Controller
 - Compliant to PCI specifications v2.1
 - Four 32-bit PCI slots (Masters) and four ISA slots, 4-layer PCB
 - **Supports Universal Serial Bus — USB**
- Peripheral Controller
 - System BIOS built-in NCR306 SCSI Card BIOS and “Plug and Play” function
 - On-board built-in PCI Master IDE controller and floppy controller
 - On-board supports for two high speed UARTS (w/i 16550 FIFO), one ECP/EPP/SPP compatible parallel port, and one PS/2 mouse port
 - **On-board supports FLASH Memory for easy upgrade BIOS**
 - **Easy installation of Triones EIDE/ATAPI CD-ROM Bus Master Drivers**

Unpacking the Mainboard

The mainboard package contains:

- The 82430VX Mainboard
- This User's Guide
- One IDE Bus Master driver

Note: Do not unpack the mainboard until you are ready to install it.

Follow the precautions below while unpacking the mainboard.

1. Before handling the mainboard, ground yourself by grasping an unpainted portion of the system's metal chassis.
2. Remove the mainboard from its anti-static packaging and place it on a grounded surface, component side up.
3. Check the mainboard for damage. If any chip appears loose, press carefully to seat it firmly in its socket.

Do not apply power if the mainboard appears damaged. If there is damage to the board contact your dealer immediately.

Electrostatic Discharge Precautions

Make sure you ground yourself before handling the mainboard or other system components. Electrostatic discharge can easily damage the components. Note that you must take special precaution when handling the mainboard in dry or air-conditioned environments.

Take these precautions to protect your equipment from electrostatic discharge:

- Do not remove the anti-static packaging until you are ready to install the mainboard and other system components.
- Ground yourself before removing any system component from its protective anti-static packaging. To ground yourself grasp the expansion slot covers or other unpainted portions of the computer chassis.
- Frequently ground yourself while working, or use a grounding strap.
- Handle the mainboard by the edges and avoid touching its components.

Mainboard Layout w/ Default Settings

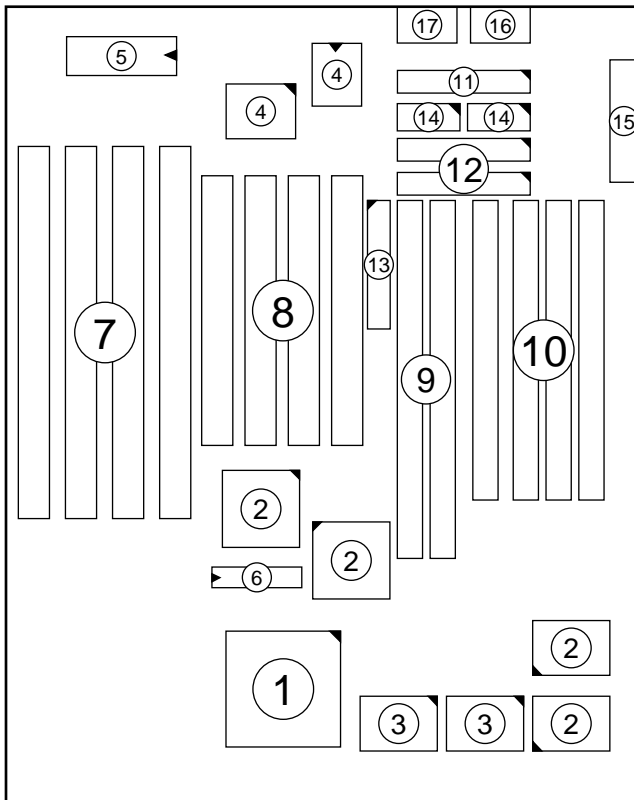

Figure 1-1. Mainboard Layout

- | | |
|---------------------------------|-----------------------------|
| 1. ZIF socket 7 (for P54C/P55C) | 10. SIMM Bank |
| 2. 82430 VX Chipset | 11. Floppy Connector |
| 3. Pipelined Burst SRAM | 12. IDE1/IDE2 Connector |
| 4. Ultra I/O Chip | 13. Parallel Port Connector |
| 5. PnP FLASH BIOS | 14. COM1/COM2 Connector |
| 6. TAG SRAM | 15. AT Power Connector |
| 7. ISA Slots | 16. KB Connector |
| 8. PCI Slots | 17. PS/2 Mouse Connector |
| 9. Unbuffered DIMM Bank | |

Default settings are as follows: Pentium 133MHz (P54C) CPU, 256K Pipelined Burst cache, On-board PCI E-IDE Enabled, 2 high speed UARTS Enabled (w/ 16550 FIFO), 1 EPP/ECP port (ECP + EPP mode), and 5V DRAM/3.3V DIMM.

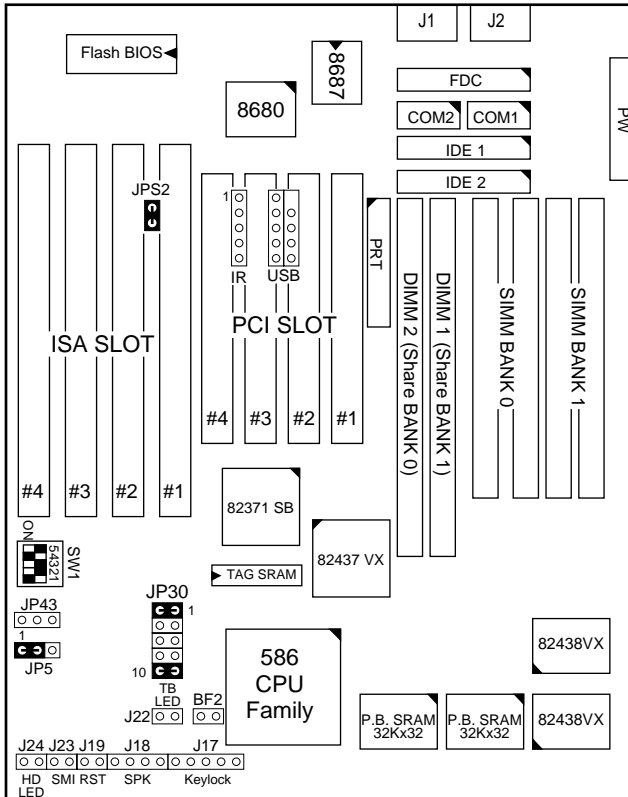

Figure 1–2. Mainboard Default Setting

Important: Make sure the system is well ventilated to prevent overheating and ensure system stability.

2 Hardware Setup



This chapter explains how to configure the mainboard's hardware. After you install the mainboard, you can set jumpers, install memory on the mainboard, and make case connections. Refer to this chapter whenever you upgrade or reconfigure your system.

CAUTION: *Turn off power to the mainboard, system chassis, and peripheral devices before performing any work on the mainboard or system.*

Jumpers



JP5: CMOS Clear Jumper

Clear the CMOS memory by momentarily shorting pin 2–3; then shorting pin 1–2 to retain new settings.

CMOS Setting	JP5
Retain CMOS data (default)	 1
Clear CMOS data	 1

JP52: PS/2 Mouse Function Jumper

Set PS/2 mouse function enabled or disabled.

PS/2 Mouse Function	JP52
Disabled	
Enabled (default)	

Note: The IRQ12 is dedicated to the PS/2 mouse when choosing enabled of PS/2 Mouse Function.

JP43: CPU Cooling Fan Connector

This 3-pins connector provides 12V power for the CPU cooling fan which matches the pin assignment of this connector.

CPU Cooling Fan Connector (Pin Assignment)	
○	1 (GND)
○	2 (12V)
○	3 (GND)

Note: Make sure the pin assignment is matched with this connector before connecting it, otherwise, you may damage either the mainboard or the cooling fan.

CPU Type Configuration

This section shows you how to configure your CPU step by step. Note that you need to check the CPU voltage before installation.

□ Step 1: Frequency Setting

Pentium – 75/90/100 CPU Settings (1.5 x clock)

AMD K5 – PR75/PR90/PR100/PR120/PR133 (1.5 x clock)

**Pentium – 75/50 MHz
AMD K5 – PR 75/50MHz**



**Pentium – 90/60 MHz
AMD K5 – PR 90/60MHz
AMD K5 – PR 120/60 MHz**



**Pentium – 100/66 MHz
AMD K5 – PR 100/66 MHz
AMD K5 – PR 133/66 MHz**

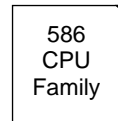
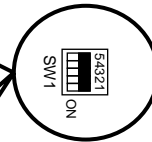

Figure 2–1–1. CPU Jumper Settings

- Note:*
1. You must equip the CPU with a fan and heat sink for system stability.
 2. AMD K5–PR75/90= AMD 5_k86(SSA5)–P75/90.

Pentium – 100/120/133 CPU Settings (2.0 x clock)

Cyrix 6x86/6x86L – P133+/P150+/P166+/P200+ CPU Settings (2.0 x clock)

AMD K5/K6 – PR150 CPU Setting

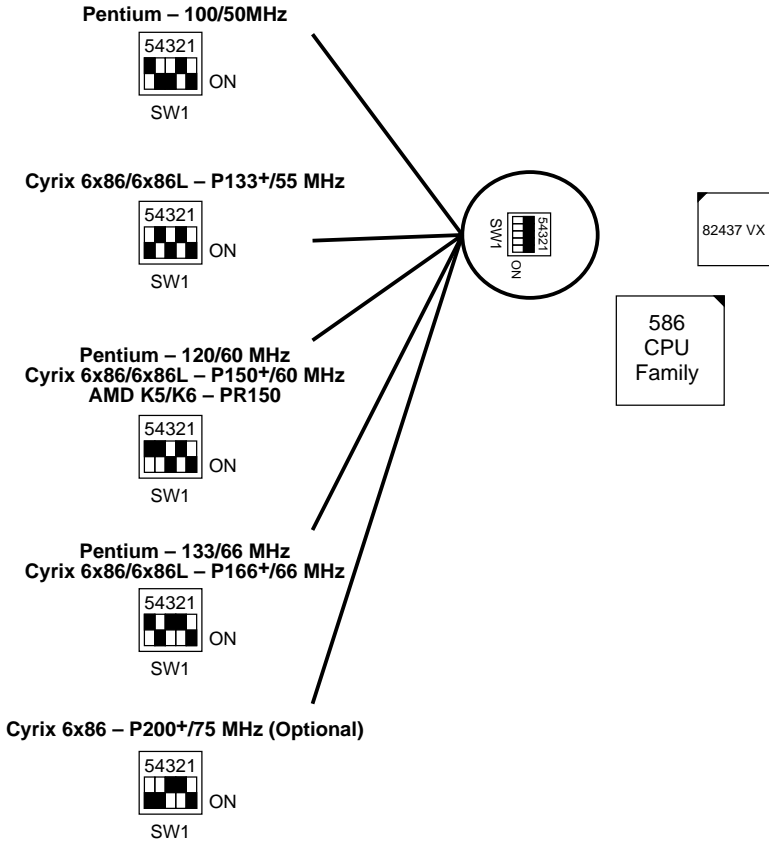

Figure 2-1-2. CPU Jumper Settings

Note: You must equip the CPU with a fan and heat sink for system stability.

**Pentium- 150/166 CPU Settings (2.5 x clock)
AMD K5/K6 – PR166 CPU Setting**

Pentium – 150/60 MHz



**Pentium – 166/66 MHz
AMD K5/K6 – PR166**

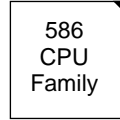
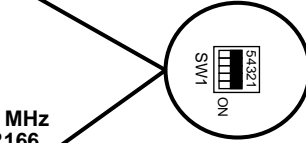
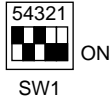

Figure 2-1-3. CPU Jumper Settings

Note: You must equip the CPU with a fan and heat sink for system stability.

**Pentium – 180/200 CPU Settings (3.0 x clock)
AMD-K6/PR2-200 (3.0 x clock)**

Pentium – 180/60 MHz



**Pentium – 200/66 MHz
AMD-K6/PR2-200**

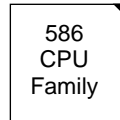
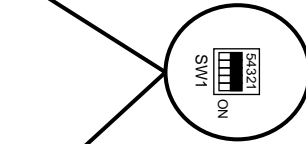

Figure 2-1-4. CPU Jumper Settings

Note: You must equip the CPU with a fan and heat sink for system stability.

Pentium – 233 CPU Settings (3.5 x clock)
AMD K6 – PR233 CPU Setting

Pentium – 233/66 MHz
 AMD K6 – PR233

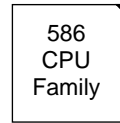
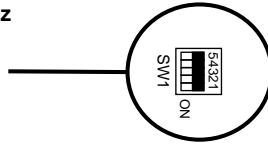

Figure 2–1–5. CPU Jumper Settings

Note: You must equip the CPU with a fan and heat sink for system stability.

AMD K6 – PR266 CPU Setting (4.0 x clock)

AMD K6 – PR266

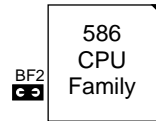
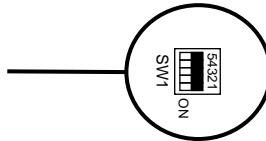

Figure 2–1–6. CPU Jumper Settings

Note: You must equip the CPU with a fan and heat sink for system stability.

□ Step 2: CPU Single/Dual Voltage Setting

Single Voltage CPU Setting

Signal voltage CPUs use the same voltage for VIO and VCore and has been used traditionally. The CPUs which fall into this category are Intel P54CX, AMD-K5-PRxxxBx, AMD-K5-PRxxxCx, AMD-K5-PRxxxFx, and Cyrix 6x86. Refer to the following figures to set these CPUs' voltage:

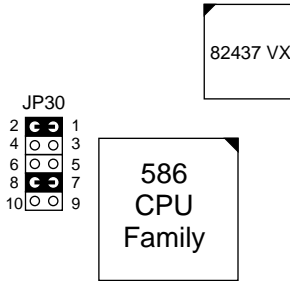

Figure 2-2-1. Single Voltage 3.3V CPU

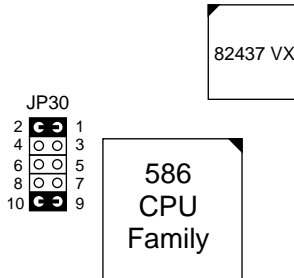
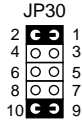

Figure 2-2-2. Single Voltage 3.52V CPU (Default)

Dual Voltage CPU Setting

Dual voltage CPUs are designed to use different voltage for VIO and VCore and they include Intel P55CX, Cyrix 6x86L, and Cyrix M2. Refer to the following figures to set these CPUs' voltage:

2.8V CPU (default)



2.9V CPU

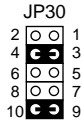

3.2V CPU

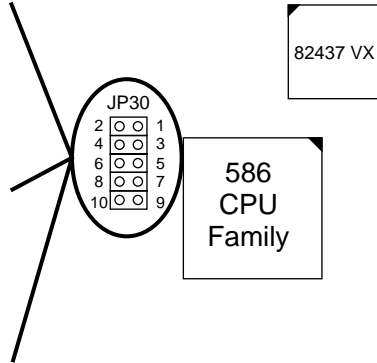
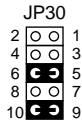

Figure 2-2-3. Intel P55CX, AMD K6, Cyrix 6X86 L/M2
Dual Voltage CPU

Note: Due to various design, please ask your CPU dealer for the exact VIO and VCore voltage before you install it.

Memory Configuration

The mainboard supports two banks of **72-pin SIMM, EDO DRAM, and two strips of 3.3V Unbuffered DIMM**. The mainboard requires SIMM of at least 70ns access time.

The mainboard supports **from 4 to 128 Mbytes** with no other restrictions on memory configurations. You can install SIMM in any combination without having to rely on a memory configuration table. Memory configuration is thus “**Table-Free**” in any SIMM bank. You must install two strips of SIMM modules to complete a bank.

RAM Bank Installation Notice

Due to the RAS line share architecture of VX chipset, the possible combination of DIMM/SIMM in this mainboard are as one of the followings:

1. In Bank 0, Bank 1, or Bank 0 & Bank 1
2. In DIMM 1, DIMM2, or DIMM 1 & DIMM 2
3. In Bank 0 & DIMM 1
4. In Bank 1 & DIMM 2

Cache Configuration

The mainboard has a write-back caching scheme. You can order 256KB or 512KB Level 2 Pipelined Burst cache onboard to improve the system performance.

Cache Size and RAM Locations

Cache Size	Cache RAM	TAG RAM	Cacheable Range
256KB	32K x32, 2 pcs on U17, U18	16K x 8 on U19	64 MB
512KB	64K x 32, 2pcs on U17, U18	16K x 8 on U19	128 MB

Multi I/O Port Addresses

Default settings for multi-I/O port addresses are shown in the table below.

Port	I/O Address	IRQ	Status
LPT1*	378H	7	ECP + EPP
COM1	3F8H	4	
COM2	2F8H	3	

* If default I/O port addresses conflict with other I/O cards (e.g. sound cards or I/O cards), you must adjust one of the I/O addresses to avoid address conflict. (You can adjust these I/O addresses from the BIOS.)

Note: Some sound cards have a default IRQ setting for IRQ7, which may conflict with printing functions. If this occurs do not use sound card functions at the same time you print.

Connectors

Attach the mainboard to case devices, or an external battery, via connectors on the mainboard. Refer to Figure 1-1 for connector locations and connector pin positions.

COM1, COM2– COM1/COM2 Connectors

Attach COM1/COM2 device cable to these connectors.

FDC Connector

Attach floppy cable to this connector.

J19 – Hardware Reset Control

Attach the Reset switch to J19. Closing the Reset switch restarts the system.

J24 – HDD LED Connectors

Attach the cable of hard disk drive LEDs to this connector. The LED lights when an HDD is active.

IDE1/IDE2 – On-board Primary/Secondary IDE HDD Connectors

Attach cables of hard disk drives to these connectors.

IR1 – IR Connector

Attach a 5-pin infrared device cable to this connector for enabling the infrared transfer function. This mainboard meets the specification of ASKIAR and HPSIR.

J2 – Keyboard Connector

A 5-pin female DIN keyboard connector is located at the rear of the board. Plug the keyboard jack into this connector.

J17 – Keylock & Power LED Connector

J17 is a connector for a lock that may be installed on the system case for enabling or disabling the keyboard. J17 also attaches to the case's Power LED. (Pin 1, 3 for power LED and pin 4, 5 for keylock.)

J1 – PS/2 Mouse Connector

Attach PS/2 mouse cable to this connector.

PRT – Parallel Port Connector

Attach parallel port cable to this connector.

PW – Power Supply Connector

The mainboard requires a power supply with at least 200 watts and a “power good” signal. PW has two 6-pin male header connectors. Plug the dual connectors from the power directly onto the board connector while making sure the black leads are in the center.

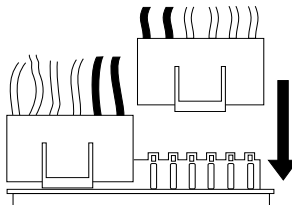

J23: Sleep Switch Connector Enable/Disable

Toggle this jumper to force the system into power saving (Green) mode. Any hardware IRQ signal makes the system wakeup.

J22 – Turbo LED Connector

Attach the turbo LED to J22. The LED lights when the system is in Turbo mode.

USB1 – Universal Serial Bus Connectors

Attach 9-pin USB cable to these connectors for external USB device.

3 BIOS Setup

The mainboard's BIOS setup program is the ROM PCI/ISA BIOS from Award Software Inc. Enter the Award BIOS program's Main Menu as follows:

1. Turn on or reboot the system. After a series of diagnostic checks, you are asked to press DEL to enter Setup.
2. Press the key to enter the Award BIOS program and the main screen appears:

ROM PCI/ISA BIOS
CMOS SETUP UTILITY
AWARD SOFTWARE, INC.

STANDARD CMOS SETUP	INTEGRATED PERIPHERALS
BIOS FEATURES SETUP	SUPERVISOR PASSWORD
CHIPSET FEATURES SETUP	USER PASSWORD
POWER MANAGEMENT SETUP	IDE HDD AUTO DETECTION
PNP/PCI CONFIGURATION	SAVE & EXIT SETUP
LOAD SETUP DEFAULTS	EXIT WITHOUT SAVING
LOAD BIOS DEFAULTS	
Esc : Quit	↑ ↓ → ← : Select Item
F10 : Save & Exit Setup	(Shift) F2 : Change Color
Time, Date, Hard Disk Type...	

3. Choose an option and press <Enter>. Modify the system parameters to reflect the options installed in the system. (See the following sections.)
4. Press <ESC> at anytime to return to the Main Menu.
5. In the Main Menu, choose "SAVE AND EXIT SETUP" to save your changes and reboot the system. Choosing "EXIT WITHOUT SAVING" ignores your changes and exits the program.

The Main Menu options of the Award BIOS are described in the sections that follow.

Standard CMOS Setup

Run the Standard CMOS Setup as follows.

1. Choose "STANDARD CMOS SETUP" from the Main Menu. A screen appears.

ROM PCI/ISA BIOS
STANDARD CMOS SETUP
AWARD SOFTWARE, INC.

Date (mm:dd:yy) : Fri, Feb 1 1995								
Time (hh:mm:ss) : 7 : 30 : 33								
HARD DISKS	TYPE	SIZE	CYLS	HEAD	PRECOMP	LANDZ	SECTOR	MODE
Primary Master	: AUTO	0	0	0	0	0	0	AUTO
Primary Slave	: None	0	0	0	0	0	0	----
Secondary Master	: None	0	0	0	0	0	0	----
Secondary Slave	: None	0	0	0	0	0	0	----
Drive A : 1.44M, 3.5 in.					Base Memory: 640K			
Drive B : None					Extended Memory: 3328K			
Video : EGA/VGA					Other Memory: 128K			
Halt On : All Errors					Total Memory: 4096K			
Esc : Quit		↑ ↓ → ← : Select Item			PU/PD/+/- : Modify			
F11 : Help		(Shift) F2 : Change Color			F3 : Toggle Calendar			

2. Use arrow keys to move between items and select values. Modify selected fields using PgUp/PgDn/+/- keys. Some fields let you enter values directly.

Date (mm/dd/yy) Type the current date.

Time (hh:mm:ss) Type the current time.

Primary (Secondary) First, choose the type of hard disk that you already installed:

Master & Slave

- Auto – BIOS detects hard disk type automatically (default)
- 1 ~ 46 – Selects standard hard disk type
- User – User defines the type of hard disk.

Next, choose hard disk mode:

- Auto – BIOS detects hard disk mode automatically (default)
- Normal – Normal IDE hard disk (smaller than 528MB)
- LBA – Enhanced-IDE hard disk (larger than 528MB)

Primary (Secondary) Master & Slave (Continued)	Large – Large IDE hard disk (for certain hard disk) <i>Note: If you have any questions on your hard disk type or mode, ask your hard disk provider or previous user for details.</i>
Drive A & B	Choose 360KB , 5 1/4 in., 1.2MB , 5 1/4 in., 720KB , 3 1/2 in., 1.44M , 3 1/2 in.(default), 2.88 MB, 3 1/2 in. or Not installed
Video	Choose Monochrome, Color 40x25, VGA/EGA (default), Color 80x25
Halt On	Choose halt mode when BIOS detects system errors: All Errors (default) All, But Diskette No Errors All, But Keyboard All, But Disk/Key

3. When you finish, press the <ESC> key to return to the Main Menu.

BIOS Features Setup

Run the BIOS Features Setup as follows.

1. Choose “BIOS FEATURES SETUP” from the Main Menu and a screen with a list of items appears. (**The screen below shows the BIOS default settings.**)

ROM PCI/ISA BIOS
BIOS FEATURES SETUP
AWARD SOFTWARE, INC.

CPU Internal Cache	: Enabled	Video BIOS Shadow	: Enabled
External Cache	: Enabled	C8000-CBFFF Shadow	: Disabled
Quick Power on Self Test	: Enabled	CC000-CFFFF Shadow	: Disabled
Boot Sequence	: A,C,SCSI	D0000-D3FFF Shadow	: Disabled
Swap Floppy Drive	: Disabled	D4000-D7FFF Shadow	: Disabled
Boot Up NumLock Status	: On	D8000-DBFFF Shadow	: Disabled
Gate A20 Option	: Fast	DC000-DFFFF Shadow	: Disabled
Typematic Rate Setting	: Disabled		
Typematic Rate (Chars/Sec)	: 6	ESC : Quit	↑ ↓ → ← : Select Item
Typematic Delay (Msec)	: 250	F1 : Help	PU/PD/+/- : Modify
Security Option	: Setup	F5 : Old Values (Shift)	F2 : Color
PCI/VGA Palette Snoop	: Disabled	F6 : Load BIOS Defaults	
OS Select for DRAM >64MB	: Non-OS2	F7 : Load Setup Defaults	

2. Use the arrow keys to move between items and to select values. Modify the selected fields using the PgUp/PgDn/+/- keys. <F> keys are explained below:
 - <F1>: “Help” gives options available for each item.
 - Shift <F2>: Change color.
 - <F5>: Get the old values. These values are the values with which the user started the current session.
 - <F6>: Load all options with the BIOS Setup default values.
 - <F7>: Load all options with the Power-On default values.

A short description of screen items follows:

CPU Internal Cache This option enables/disables the CPU’s internal cache. (The Default setting is Enabled.)

External Cache This option enables/disables the external cache memory. (The Default setting is Enabled.)

Quick Power On Self Test Enabled provides a fast POST at boot-up .

Boot Sequence	Choose the boot device sequence as your need. For example, "A, C, SCSI" means BIOS will look for an operating system first from drive A, drive C, then SCSI device. Options of this function are: A, C, SCSI C, A, SCSI C, CD-ROM, A CD-ROM, C, A D, A, SCSI E, A, SCSI F, A, SCSI SCSI, A, C SCSI, C, A C only.
Swap Floppy Drive	Enabled changes the sequence of the drive A and drive B to drive B and drive A. (The Default setting is Disabled.)
Boot Up Num Lock Status	Choose On or Off . On puts numeric keypad in Num Lock mode at boot-up. Off puts this keypad in arrow key mode at boot-up.
Gate A20 Option	Choose Fast (default) or Normal . Fast allows RAM accesses above 1MB using the fast gate A20 line.
Typematic Rate Setting	Enable this option to adjust the keystroke repeat rate.
Typematic Rate (Chars/Sec)	Choose the rate a character keeps repeating.
Typematic Delay (Msec)	Choose how long after you press a key that a character begins repeating.

Security Option Choose **Setup** or **System**. Use this feature to prevent unauthorized system boot-up or use of BIOS Setup.

“System” – Each time the system is booted the password prompt appears.

“Setup”– If a password is set, the password prompt only appears if you attempt to enter the Setup program.

**PCI/VGA
Palette Snoop**

Enabled: The color of the monitor may be incorrect if uses with MPEG card. Enable this option to make the monitor normal.

Disabled: Default setting.

**OS Select for
DRAM >64MB**

OS2: Choosing this when you are using OS/2 operation system.

Non-OS/2: Choosing this when you are using no-OS/2 operation system.

**Video or
Adapter BIOS
Shadow**

BIOS shadow copies BIOS code from slower ROM to faster RAM. BIOS can then execute from RAM. These 16K segments can be shadowed from ROM to RAM. BIOS is shadowed in a 16K segment if it is enabled and it has BIOS present.

3. After you have finished with the BIOS Features Setup program, press the <ESC> key and follow the screen instructions to save or disregard your settings.

Chipset Features Setup

The Chipset Features Setup option changes the values of the chipset registers. These registers control system options in the computer.

Note: Change these settings only if you are familiar with the Chipset.

Run the Chipset Features Setup as follows.

1. Choose “CHIPSET FEATURES SETUP” from the Main Menu and the following screen appears. (The screen below shows default settings.)

ROM PCI/ISA BIOS CHIPSET FEATURES SETUP AWARD SOFTWARE, INC.	
Auto Configuration	: Enabled
DRAM Timing	: 70 ns
DRAM RAS# Precharge Time	: 4
DRAM R/W Leadoff Timing	: 6
Fast RAS# To CAS# Delay	: 3
DRAM Read Burst Timing	: x333X444
DRAM Write Burts Timing	: x333
Fast MA to RAS# Delay CLK	: 1
Fast EDO Path Select	: Enabled
Refresh RAS# Assertion	: 5 CLKS
ISA Bus CLock	: PCICLK/4
System BIOS Cacheable	: Disabled
Video BIOS Cacheable	: Disabled
8 Bit I/O Recovery Time	: 3
16 Bit I/O Recovery Time	: 2
Memory Hole At 15M-16M	: Disabled
Peer Concurrency	: Enabled
ESC : Quit ↑ ↓ → ← : Select Item F1 : Help PU/PD/+/- : Modify F5 : Old Values (Shift) F2 : Color F6 : Load BIOS Defaults F7 : Load Setup Defaults	

2. Use the arrow keys to move between items and select values. Modify selected fields using the PgUp/PgDn/+/- keys.

A short description of screen items follows:

Auto Configuration Enable this option (strongly recommended) and the system automatically sets all options on the left side of the screen (except cache update mode & BIOS cacheable).

If this option is Enabled you must boot from Turbo mode.

DRAM Timing Use the default setting.

DRAM R/W Leadoff Timing Use the default setting.

DRAM RAS to CAS Delay	Use the default setting.
DRAM Read Burst Timing	Use the default setting.
DRAM Write Burst Timing	Use the default setting.
Fast MA to RAS# Delay CLK	Use the default setting.
Fast EDO Path Select	Use the default setting.
Refresh RAS# Assertion	Use the default setting.
ISA Bus clock	Use BIOS default setting or choose: /4: for 60, 66 MHz CPU Bus Frequency /3: for 50, 55 MHz CPU Bus Frequency.
System BIOS Cacheable	Disabled: The ROM area F0000H-FFFFFH is not cached. Enabled: The ROM area F0000H-FFFFFH is cacheable if cache controller is enabled.
Video BIOS Cacheable	Disabled: The video BIOS C0000H-C7FFFH is not cached. Enabled: The video BIOS C0000H-C7FFFH is cacheable if cache controller is enabled.
8Bit I/O Recovery Time	Use the default setting.
16Bit I/O Recovery Time	Use the default setting.

Memory Hole At 15M-16M Choose Enabled or Disabled (default).
Some interface cards will map their ROM address to this area. If this occurs, you should select Enabled, otherwise use Disabled.

Peer Concurrency Use the default setting.

3. After you have finished with the Chipset Features Setup, press the <ESC> key and follow the screen instructions to save or disregard your settings.

Power Management Setup

The Power Management Setup option sets the system's power saving functions.

Run the Power Management Setup as follows.

1. Choose "POWER MANAGEMENT SETUP" from the Main Menu and a screen with a list of items appears.

ROM PCI/ISA BIOS CMOS SETUP UTILITY POWER MANAGEMENT SETUP	
Power Management : Disabled	** Power Down & Resume Events **
PM Control by APM : Yes	IRQ 3 (COM 2) : ON
Video Off Method : V/H SYNC+Blank	IRQ 4 (COM 1) : ON
	IRQ 5 (LPT 2) : ON
Doze Mode : Disabled	IRQ 6 (Floppy Disk) : OFF
Standby Mode : Disabled	IRQ 7 (LPT 1) : ON
Suspend Mode : Disabled	IRQ 8 (RTC Alarm) : OFF
HDD Power Down : Disabled	IRQ 9 (IRQ2 Redir) : ON
	IRQ 10 (Reserved) : ON
	IRQ 11 (Reserved) : ON
** Wake Up Events In Doze & Standby **	IRQ 12 (PS/2 mouse) : ON
IRQ3 (Wake-Up Event) : ON	IRQ 13 (Coprocessor) : ON
IRQ3 (Wake-Up Event) : ON	IRQ 14 (Hard Disk) : ON
IRQ3 (Wake-Up Event) : ON	IRQ 15 (Reserved) : ON
IRQ12 (Wake-Up Event) : ON	
	ESC : Quit ↑↓ → ← : Select Item
	F1 : Help PU/PD/+/- : Modify
	F5 : Old Values (Shift) F2 : Color
	F6 : Load BIOS Defaults
	F7 : Load Setup Defaults

2. Use the arrow keys to move between items and to select values. Modify the selected fields using the PgUp/PgDn/+/- keys.

A short description of selected screen items follows:

Power Management	Options are as follows:
User Define	Let's you define the HDD and system power down times.
Disabled	Disables the Green PC Features.
Min Saving	Doze timer = 1 Hour Standby timer = 1 Hour Suspend timer = 1 Hour HDD Power Down = 15 Min
Max Saving	Doze timer = 1 Min Standby timer = 1 Min Suspend timer = 1 Min HDD Power Down = 1 Min

PM Control by APM	Choose Yes (default) or No . APM stands for Advanced Power Management. To use APM, you must run “power.exe” under DOS v6.0 or later version.
Video Off Method	Choose V/H Sync+Blank (default), Blank screen, or DPMS for the selected PM mode.
Doze Mode	When the set time has elapsed, the BIOS sends a command to the system to enter doze mode (system clock drops to 33MHz). Time is adjustable from 1 Min to 1 Hour.
Standby Mode	The default is Disabled. Time is adjustable from 1 Min to 1 Hour.
Suspend Mode	The default is Disabled. Only an SL-Enhanced (or SMI) CPU can enter this mode. Time is adjustable from 1 Min to 1 Hour. Under Suspend mode, the CPU stops completely (no instructions are executed.)
HDD Power Down	When the set time has elapsed, the BIOS sends a command to the HDD to power down, which turns off the motor. Time is adjustable from 1 to 15 minutes. The default setting is Disabled. Some older model HDDs may not support this advanced function.
IRQx (Wake-Up Events)	The BIOS monitors these items for activity. If activity occurs from the Enabled item the system wakes up.
Power Down Activities	The BIOS monitors these items for no activity. If no activity occurs from the Enabled item the system will enter power saving mode (Doze/Standby/Suspend/ HDD Power Down mode) .

3. After you have finished with the Power Management Setup, press the <ESC> key to return to the Main Menu.

PNP/PCI Configuration Setup

This option sets the mainboard's PCI Slots. Run this option as follows:

1. Choose "PNP/PCI CONFIGURATION SETUP" from the Main Menu and the following screen appears. (The screen below shows default settings.)

ROM PCI/ISA BIOS
PNP/PCI CONFIGURATION
AWARD SOFTWARE, INC.

Resources Controlled By : Manual	PCI IRQ Activated By : Level
Reset Configuration Data : Disabled	PCI IDE IRQ Map To : PCI-AUTO
IRQ-3 assigned to : Legacy ISA*	Primary IDE INT# : A
IRQ-4 assigned to : Legacy ISA*	Secondary IDE INT# : B
IRQ-5 assigned to : PCI/ISA PnP*	Used MEM Base Addr : N/A
IRQ-7 assigned to : PCI/ISA PnP*	(Used MEM Length : 8K)
IRQ-9 assigned to : PCI/ISA PnP*	
IRQ-10 assigned to : PCI/ISA PnP*	
IRQ-11 assigned to : PCI/ISA PnP*	
IRQ-12 assigned to : PCI/ISA PnP*	
IRQ-14 assigned to : PCI/ISA PnP*	
IRQ-15 assigned to : PCI/ISA PnP*	
DMA-0 assigned to : PCI/ISA PnP*	ESC : Quit ↑↓→←: Select Item
DMA-1 assigned to : PCI/ISA PnP*	F1 : Help PU/PD/+/- : Modify
DMA-3 assigned to : PCI/ISA PnP*	F5 : Old Values (Shift)F2 : Color
DMA-5 assigned to : PCI/ISA PnP*	F6 : Load BIOS Defaults
DMA-6 assigned to : PCI/ISA PnP*	F7 : Load Setup Defaults
DMA-7 assigned to : PCI/ISA PnP*	

*: These items will disappear when Resource Controlled. is Auto.

2. Use the arrow keys to move between items and select values. Modify selected fields using the PgUp/PgDn/+/- keys.

A short description of screen items follows:

Resources Controlled By Manual: BIOS doesn't manage PCI/ISA PnP card (i.e., IRQ) automatically.

Auto: BIOS auto manage PCI and ISA PnP card (recommended).

Reset Configuration Data Disabled: Retain PnP configuration data in BIOS.

Enabled: Reset PnP configuration data in BIOS.

IRQX and DMAX assigned to Choose PCI/ISA PnP or Legacy ISA. If the first item is set to Manual, you could choose IRQX and DMAX assigned to PCI/ISA PnP card or ISA card.

PCI IRQ Activated By Choose Edge or Level. Most PCI trigger signals are Level. This setting must match the PCI card.

PCI IDE IRQ Map To Select PCI-AUTO, ISA, or assign a PCI SLOT number (depending on which slot the PCI IDE is inserted). The default setting is PCI-AUTO. If PCI-AUTO does not work, then assign an individual PCI SLOT number.

Primary IDE INT# Choose INTA#, INTB#, INTC#, or INTD#. The default setting is INTA#.

Secondary IDE INT# Choose INTA#, INTB#, INTC#, or INTD#. The default setting is INTB#.

Used MEM Base Addr Choose C800, CC00, D000, D400, D800, or DC00 for setting the I/O address of your add-on card. You should ask your add-on card dealer for the exactly I/O address. Use this function only when problems occur while using the add-on card.

Used MEM Length Choose 8, 16, 32, or 64 for setting the I/O address length of your add-on card. You should ask your add-on card dealer for the exactly I/O address length. This item appears only when you specify the add-on card I/O address.

3. After you have finished with the PCI Slot Configuration, press the <ESC> key and follow the screen instructions to save or disregard your settings.

Load Setup Defaults

This item loads the system values you have previously saved. Choose this item and the following message appears:

“Load SETUP Defaults (Y/N)? N”

To use the SETUP defaults, change the prompt to “Y” and press <Enter>. This item is recommended if you need to reset the system setup.

Note: The SETUP Defaults are optimized for the most stabilized performance.

Load BIOS Defaults

Choose this item and the following message appears:

“Load BIOS Defaults (Y/N)?N”

To use the BIOS defaults, change the prompt to “Y” and press <Enter>.

Note: BIOS DEFAULTS values are adjusted for high performance. If you run into any problems after loading BIOS DEFAULTS, please load the SETUP DEFAULTS for the stable performance.

Integrated Peripherals

The Integrated Peripherals option changes the values of the chipset registers. These registers control system options in the computer.

Note: Change these settings only if you are familiar with the Chipset.

Run the Integrated Peripherals as follows.

1. Choose “Integrated Peripherals” from the Main Menu and the following screen appears. (The screen below shows default settings:)

ROM PCI/ISA BIOS INTEGRATED PERIPHERALS AWARD SOFTWARE, INC.	
IDE HDD Block Mode : Enabled	
PCI Slot IDE 2nd Channel : Enabled	
On-Chip Primary PCI IDE: Enabled	
On-Chip Secondary PCI IDE: Enabled	
IDE Primary Master PIO : Auto	
IDE Primary Slave PIO : Auto	
IDE Secondary Master PIO : Auto	
IDE Secondary Slave PIO : Auto	
USB Controller : Disabled	
Onboard FDD Controller : Enabled	
Onboard Serial Port 1 : 3F8/IRQ4	
Onboard Serial Port 2 : 2F8/IRQ3	
UR2 Mode : Standard	
UR2 Duplex Mode : Half	
Onboard Parallel Port : 378H/IRQ7	
Parallel Port Mode : ECP+EPP	
ECP Mode Use DMA : 3	
	ESC : Quit ↑ ↓ → ← : Select Item
	F1 : Help PU/PD/+/- : Modify
	F5 : Old Values (Shift)F2 : Color
	F6 : Load BIOS Defaults
	F7 : Load Setup Defaults

2. Use the arrow keys to move between items and select values. Modify selected fields using the PgUp/PgDn/+/- keys.

A short description of screen items follows:

IDE HDD Block Mode Choose Enabled (default) or Disabled. Enabled invokes multi-sector transfer instead of one sector per transfer. Not all HDDs support this function.

PCI Slot IDE 2nd Channel Choose Enabled (default) or Disabled. When Enabled is set, IRQ15 is dedicated for secondary IDE use. When Disabled is set, IRQ15 is released for other devices.

On-chip Primary PCI IDE/ On-chip Secondary PCI IDE	Enabled: Use the on-board IDE (default) Disabled: Turn off the on-board IDE
IDE Primary Master PIO/ IDE Primary Slave PIO/ IDE Secondary Master PIO/ IDE Secondary Slave PIO	Choose Auto (default) or mode 0~4. Mode 0 is the slowest speed, and HDD mode 4 is the fastest speed. For better performance and stability, we suggest you use the Auto setting to set the HDD control timing.
USB Controller	Enabled it when you use USB device.
Onboard FDC Controller	Enabled: Use the on-board floppy controller (default). Disabled: Turn off the on-board floppy controller.
Onboard Serial Port 1/ Onboard Serial Port 2	Choose serial port 1 & 2's I/O address. Do no set port 1 & 2 to the same value except for Disabled. COM 1/3F8H COM3/3E8H COM 2/2F8H COM4/2E8H (default)
UR2 Mode	Choose Standard (default), IrDA1.0, ASKIR, MIR 0.57M, MIR 1.15M, or FIR to meet the specification of your Infra Red device.
UR2 Duplex Mode	Choose Half or Full to meet the specification of your Infra Red device. This option appears only when you choose everything but Standard in the UR2 Mode function.
Onboard Parallel Port	Choose the printer I/O address: 378H/IRQ7 (default), 3BCH/IRQ7, 278H/IRQ5

- Printer Port Mode** Choose ECP + EPP (default), SPP or EPP, ECP mode. The mode depends on your external device that connects to this port.
- ECP Mode Use DMA** Choose DMA3 (default) or DMA1. This setting only works when the Onboard Printer Mode is set at the ECP mode.

Supervisor Password

Based on the setting you made in the “Security Option” of the “BIOS FEATURES SETUP”, this Main Menu item lets you configure the system so that a password is required every time the system boots or an attempt is made to enter the Setup program. Change the password as follows:

1. Choose “SUPERVISOR PASSWORD” in the Main Menu and press <Enter>. The following message appears:

“Enter Password:”

2. Enter a password and press <Enter>. (If you do not wish to use the password function, you can just press <Enter> and a “Password disabled” message appears.)
3. After you enter your password, the following message appears prompting you to confirm the new password:

“Confirm Password:”

4. Re-enter your password and then Press <ESC> to exit to the Main Menu.

Important: *If you forget or lose the password, the only way to access the system is to set jumper JP5 to clear the CMOS RAM. All setup information is lost and you must run the BIOS setup program again.*

User Password

Based on the setting you made in the “Security Option” of the “BIOS FEATURES SETUP”, this Main Menu item lets you configure the system so that a password is required every time the system boots or an attempt is made to enter the Setup program. Change the password as follows:

1. Choose “USER PASSWORD” in the Main Menu and press <Enter>. The following message appears:

“Enter Password:”

2. Enter a password and press <Enter>. (If you do not wish to use the password function, you can just press <Enter> and a “Password disabled” message appears.)
3. After you enter your password, the following message appears prompting you to confirm the new password:

“Confirm Password:”

4. Re-enter your password and then Press <ESC> to exit to the Main Menu.
5. You are not allowed to change any setting in “CMOS SETUP UTILITY” except change user’s password.

Important: If you forget or lose the password, the only way to access the system is to set jumper JP5 to clear the CMOS RAM. All setup information is lost and you must run the BIOS setup program again.

IDE HDD Auto Detection

This Main Menu item automatically detects the hard disk type and configures the STANDARD CMOS SETUP accordingly.

Note: This function is only valid for IDE hard disks.

ROM PCI/ISA BIOS
CMOS SETUP UTILITY
AWARD SOFTWARE, INC.

HARD DISKS	TYPE	SIZE	CYLS	HEAD	PRECOMP	LANDZ	SECTOR	MODE
Primary Master	: None	0	0	0	0	0	0	----
Primary Slave	: None	0	0	0	0	0	0	----
Secondary Master	: None	0	0	0	0	0	0	----
Secondary Slave	: None	0	0	0	0	0	0	----

Do you accept this drive C (Y/N)? N

ESC : Skip

4 Drivers Installation Guide

IDE BUS Master Installation Guide

MS-DOS/WINDOWS/WFW

- 1) You should install CD-ROM in secondary channel in Windows (WFW).
- 2) Change the current directory to a: or b:.
- 3) Under DOS command line prompt, run the SETUP directly.

After entering the setup utility, just follow the instructions of the setup.

WINDOWS NT3.5/4.0

- 1) From the Program Manager, double click on “Windows NT Setup” in the Main group.
- 2) Select “Options/Add/Remove SCSI Adapters...”.
- 3) Click on Add.
- 4) The “Select SCSI Adapter Option” dialog will appear; select “Other (Requires a disk from a hardware manufacturer)” from the “Adapter:” list box.
- 5) Next, the “Insert Diskette” dialog box will appear; insert the Triones PIIX/PIIX3 Bus Master EIDE/ATAPI Driver disk into Drive A: and type in “a:\winnt35” and <Return>.
- 6) Next, the “Select OEM Option” dialog box will appear; select “PIIX/PIIX3 Bus Master EIDE/ATAPI” and click “OK”.
- 7) Next, the “Select SCSI Adapter Option” dialog box will appear; click on the “Install” button in the dialog box. If installation is successful, the “SCSI Adapter Setup” dialog box will reappear, and “PIIX/PIIX3 Bus Master EIDE/ATAPI” will be listed. That means the driver is installed.
- 8) Reboot your system to load the driver.

WINDOWS 95

- 1) Close any running applications.
- 2) Insert the floppy disk into drive A:.
- 3) Open "My Computer", double click "Drive A:."
- 4) Double click "Win95".
- 5) Double click the Setup program.
- 6) Then just follow the instruction.

NOVELL 3.X&4.X

- 1) Copy the driver TRIN4X.DSK or TRIN312.DSK to the subdirectory which holds the file SERVER.EXE.
- 2) Boot up the file server.
- 3) On the system console and on the command prompt state, type in:
load TRIN4X.DSK <Enter> or **load TRIN312.DSK <Enter>**

You can also include the above command line into the start up file STARTUP.NCF to load the driver automatically.

SCO UNIX

- 1) Install SCO UNIX 3.2.x or SCO Open Desktop 3.x using the default SCO IDE driver.
- 2) Reboot your SCO UNIX system
- 3) Insert Triones supplied diskette into the 3.5 inch floppy drive of your system. Use doscp command to copy the file TRISCO.TAR to your /tmp directory. for example, if you are using floppy drive A, type: doscp a:/scounix/trisco.tar/tmp/trisco.tar
- 4) From root directory, type the following commands:
mkdir/inst
cd /inst
tar xvf /tmp/trisco.tar.
(Note: there is a period at the end of the last command.)

- 5) Now, insert a blank diskette into the floppy drive A and type:
tar cvf /dev/<your floppy drive A device name>.

(Note: there is a period at the end of the last command.)

Your floppy drive A device name could be:

- rfd096ds15,5.25 DSHD
- rfd0135ds18 3.5 DSHD
- rfd048ds9 5.25 DSDD
- rfd0135ds9 3.5 DSDD

Now you have already made an installation diskette for the device driver.

Start the installation by typing: **custom**.

- 6) Select the “Install” operation and then follow the guided steps.
When prompted “Do you want to set the device configuration (y/n)”,
answer “n”.
- 7) Reboot your SCO UNIX system.

SCO UNIX 5.0

- 1) Install SCO UNIX 5.0 using the default SCO IDE driver.
- 2) Reboot your SCO UNIX system
- 3) Insert Triones supplied diskette into the 3.5 inch floppy drive of your system. Use doscp command to copy the file TRISCO.TAR to your /tmp directory. for example, if you are using floppy drive A, type: doscp a:/scounix/trisco5.tar/tmp/trisco5.tar
- 4) From root directory, type the following commands:
mkdir/inst
cd /inst
tar xvf /tmp/trisco.tar.
(Note: there is a period at the end of the last command.)
- 5) Install the driver by typing:
./install
- 6) Reboot your SCO UNIX system..

OS/2 2.0 and WARP 3.X

- 1) Copy TRIOS2.ADD from the floppy diskette to your hard disk under the OS2 directory (i.e., C:\OS2).
- 2) Edit C:\CONFIG.SYS to replace **BASEDEV=IBM1S506.ADD** with **BASEDEV=TRIOS2.ADD**
- 3) Reboot the system.

Note: For more information (like parameter settings, driver de-installation, etc.), please refer to the README.TXT file on the diskette.