

Roland

OWNER'S MANUAL

SOUND Canvas

MIDI SOUND GENERATOR SC-55mkII

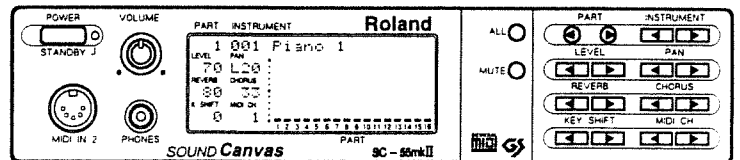

GENERAL
MIDI



Information

When you need repair service, call your local Roland Service Station or the authorized Roland distributor in your country as shown below.

U. S. A.

Roland Corporation US
7200 Dominion Circle
Los Angeles, CA. 90040-3696,
U. S. A.
TEL: (213) 685-5141

CANADA

Roland Canada Music Ltd.
(Head Office)
5480 Parkwood Way
Richmond B. C., V6V 2M4
CANADA
TEL: (604) 270-6626

Roland Canada Music Ltd.

(Montreal Office)
9425 Transcanadienne
Service Rd. N., St Laurent,
Quebec H4S 1V3, CANADA
TEL: (514) 335-2009

Roland Canada Music Ltd.

(Toronto Office)
346 Watline Avenue,
Mississauga, Ontario L4Z
1X2, CANADA
TEL: (416) 890-6488

AUSTRALIA

Roland Corporation Australia Pty. Ltd.
38 Campbell Avenue Dee
Why West, NSW 2099
AUSTRALIA
TEL: (02) 982-8266

NEW ZEALAND

Roland Corporation (NZ) Ltd.
97 Mt. Eden Road, Mt. Eden,
Auckland 3, NEW
ZEALAND
TEL: (09) 3098-715

UNITED KINGDOM

Roland (U.K.) Ltd.
Rve Close Ancells Business
Park Fleet, Hampshire GU13
8UY, UNITED KINGDOM
TEL: 0252-816181

Roland (U.K.) Ltd., Swansea Office

Atlantic Close, Swansea
Enterprise Park, Swansea,
West Glamorgan SA79FL,
UNITED KINGDOM
TEL: (0792) 700-139

ITALY

Roland Italy S. p. A.
Viale delle Industrie 8 20020
ARESE MILANO ITALY
TEL: 02-93581311

SPAIN

Roland Electronics de España, S. A.
Calle Bolivia 239 08020
Barcelona, SPAIN
TEL: 93-308-1000

GERMANY

Roland Elektronische Musikinstrumente Handelsgesellschaft mbH.
Oststrasse 96, 2000
Norderstedt, GERMANY
TEL: 040/52 60 090

FRANCE

Musikengro
102 Avenue Jean-Jaures
69007 Lyon Cedex 07
FRANCE
TEL: (7) 858-54 60

Musikengro (Paris Office)

Centre Region Parisienne 41
rue Charles-Fourier, 94400
Vitry SUR/SEINE FRANCE
TEL: (1) 4680 86 62

BELGIUM/HOLLAND/LUXEMBOURG

Roland Benelux N. V.
Houtstraat 1 B-2260 Oevel-
Westerlo BELGIUM
TEL: (0032) 14-575811

DENMARK

Roland Scandinavia A/S
Langebrogade 6 Box 1937
DK-1023 Copenhagen K,
DENMARK
TEL: 31-95 31 11

SWEDEN

Roland Scandinavia A/S
Danvik Center 28 A, 2 tr. S-
131 30 Nacka SWEDEN
TEL: 08-702 00 20

NORWAY

Roland Scandinavia Avd. Kontor Norge
Lilleakerveien 2 Postboks 95
Lilleaker N-0216 Oslo 2
NORWAY
TEL: 22-73 00 74

FINLAND

Fazer Musik Inc.
Länsituulentie POB 169, SF-
02101 Espoo FINLAND
TEL: 0-43 50 11

SWITZERLAND

Musitronic AG
Gerberstrasse 5, CH-4410
Liestal, SWITZERLAND
TEL: 061/921 16 15

Roland CK (Switzerland) AG

Postfach/Hauptstrasse 21
CH-4456 Tenniken
SWITZERLAND
TEL: 061/98 60 55
Repair Service by Musitronic AG

AUSTRIA

E. Dematte & Co.
Neu-Rum Siemens-Strasse 4
A-6021 Innsbruck Postfach
591 AUSTRIA
TEL: (0512) 63 451

GREECE

V. Dimitriadis & Co. Ltd.
20, Alexandras Avn., GR
10682 Athens, GREECE
TEL: 01-8232415

PORTUGAL

Casa Caius Instrumentos Musicais Lda.
Rua de Santa Catarina 131
4000 Porto, PORTUGAL
TEL: 02-38 44 56

HUNGARY

Intermusica Ltd.
Warehouse Area 'DEPO'
Torokbalint, Budapest
HUNGARY
TEL: (1) 1868905

ISRAEL

D.J.A. International Ltd.
11 Bar Gyiara St., Tel Aviv
ISRAEL
TEL: 972-3-5283329

CYPRUS

Radex Sound Equipment Ltd.
17 Diagorou St., P.O.Box
2046, Nicosia CYPRUS
TEL: 453426, 466423

U.A.E

Zak Electronics & Musical Instruments Co.
P.O. Box 8050
DUBAI, U.A.E
TEL: 695774

SAUDI ARABIA

Omar Badoghaish Trading Corp.
P.O. Box 5980
Jeddah, SAUDI ARABIA
TEL: 966-02-6607038

KUWAIT

Easa Husain Al-Yousifi
P.O. Box 126 Safat 13002
KUWAIT
TEL: 965-5719499

LEBANON

A. Chahine & Fils
P.O. Box 16-5857
Beirut, LEBANON
TEL: 335799

TURKEY

Barkat Sanayi ve Ticaret
Siraselviler Cad. 86/6 Taksim
Istanbul, TURKEY
TEL: 149 93 24

EGYPT

Al Fanny Trading Office
9, Ebn Hagar Askalanv
Street, Ard El Goli,
Heliopolis, Cairo, EGYPT
TEL: 2917803-665918

BRAZIL

Roland Brasil Ltda.
R. Alvarenga 591 CEP-
05509 Sao Paulo BRAZIL
TEL: (011) 813-7967
Repair Service for Roland and
Rhodes products

Oliver do Brasil S.A.

Instrumentos Musicais
Rua Botuoca. 198/206
CEP 05586-010 Vila Indiana
SAO PAULO-SP
BRAZIL
TEL: (011) 813- 4039
Repair Service for BOSS products

MEXICO

Casa Veerkamp, s.a. de c.v.
Mesones No. 21 Col. Centro
MEXICO D.F. 06080
TEL: (5) 709-3716

La Casa Wagner de Guadalajara s.a. de c.v.

Av. Corona No. 202 S.J.
C.P.44100 Guadalajara,
Jalisco MEXICO
TEL: (36) 13-1414

VENEZUELA

Musicland Digital C.A.
Av. Francisco De Miranda,
Centro Parque Cristal, Nivel
C2 Local 20 Caracas
VENEZUELA
TEL: (2)2844497

PANAMA

Productos Superiores, S.A.
Apartado 655 - Panama 1
REP. DE PANAMA
TEL: 26-3322

ARGENTINA

Instrumentos Musicales S.A.
Florida 638
(1005) Buenos Aires
ARGENTINA
TEL: (1)394-4029

HONG KONG

Tom Lee Music Co., Ltd. Service Division
22-32 Pun Shan Street,
Tsuen Wan, New Territories,
HONG KONG
TEL: 415-0911

KOREA

Cosmos Corporation Service Station
261 2nd Floor Nak-Won
arcade Jong-Ro ku, Seoul,
KOREA
TEL: (02) 742 8844

SINGAPORE

Swee Lee Company
Bras Basah Complex #03-23
Singapore 0178 SINGA-
PORE
TEL: 3367886

PHILIPPINES

G.A. Yupangco & Co. Inc.
339 Gil J. Puyat Avenue
Makati, Metro Manila 1200,
PHILIPPINES
TEL: (632)819-7551

THAILAND

Theera Music Co., Ltd.
330 Verng Nakorn Kasem,
Soi 2, Bangkok 10100,
THAILAND
TEL: 2248821

MALAYSIA

Syarikat Bentley
No.142, Jalan Bukit Bintang
55100 Kuala Lumpur,
MALAYSIA
TEL: 2421288

INDONESIA

PT Galestra Inti
Kompleks Perkantoran Duta
Merlin Blok C/59 Jl. Gajah
mada No.3-5 Jakarta 10130
INDONESIA
TEL: (021) 354604, 354606

TAIWAN

Siruba Enterprise (Taiwan) Co., LTD.
Room. 5, 9fl. No. 112
Chung Shan N.Road Sec.2
Taipei, TAIWAN, R.O.C.
TEL: (02) 5364546

SOUTH AFRICA

That Other Music Shop (PTY) Ltd.
256 Bree Street, Johannes-
burg 2001 Republic of
South Africa
TEL: 337-6573

Paul Bothner (PTY) Ltd.

17 Werdmuller Centre
Claremont 7700 Republic
of South Africa
TEL: 021-64-4030

□ Introduction

Thank you for purchasing the Roland SC - 55mkII SOUND Canvas Sound Module. The SOUND Canvas is a MIDI sound module that contains a wide variety of high quality sounds. In order to take full advantage of the SC - 55mkII 's capabilities, and to enjoy long and trouble - free service, please read this manual carefully before use.

□ CONTENTS

PRECAUTIONS	
IMPORTANT NOTES	5
FRONT AND REAR PANELS	6
TURNING THE POWER ON AND OFF	7
HOW TO USE THE REMOTE CONTROL	8
CONNECTIONS	10
LISTENING TO THE DEMO SONGS - ROM PLAY	
BASIC PROCEDURES	
PLAYING VARIOUS INSTRUMENTS	18
CHANGING THE VOLUME LEVEL/PAN	19
HOW TO ADJUST REVERB/CHORUS	20
HOW TO TRANSPOSE ALL PARTS (KEY SHIFT)	21
SELECTING INSTRUMENTS	22
HOW TO SELECT THE DRUM SET	24
PART SETTINGS	26
THE USER (COMPARE) FUNCTION	28
CONVENIENT PROCEDURES	
MUTE	30
MONITORING THE SOUND OF A PART	32
"MINUS - ONE" PLAY	34
SETTING TO THE PITCH OF ANOTHER INSTRUMENT (MASTER TUNING)	33
INITIALIZATION FOR GM/GS	36
RETURNING TO FACTORY PRESETS	37
THE SELECTING THE MT-32 "SOUND MAP"	38
CHANGING A PATCH NAME	40
STORING/RECALLING SOUND PARAMETERS	41
HOW TO SET THE BAR DISPLAY	42
ADJUSTING THE DISPLAY CONTRAST	44
FOR IMPROVED PERFORMANCE	
SELECTING INSTRUMENT VARIATIONS	45
CHANGING THE WAY THE SOUND IS OUTPUT	48
CHANGING THE SOUND PARAMETERS	52
CHANGING THE TYPE OF REVERB AND CHORUS	55
HOW TO USE VOICE RESERVE	56
STORING THE BASIC SETTINGS IN A SEQUENCER	58
STORING ALL THE SETTINGS IN A SEQUENCER	60
CHANGING THE MIDI RECEPTION CHANNEL (PART)	63
APPENDIX	
TROUBLESHOOTING	66
ERROR AND OTHER MESSAGES	67
ABOUT MIDI	68
THE GENERAL MIDI SYSTEM AND GS FORMAT	81
COMPUTER CABLE WIRING DIAGRAM	82
INSTRUMENT TABLE	84
DRUM SET TABLE	88
MIDI IMPLEMENTATION	90
MIDI IMPLEMENTATION CHART	105
TABLE OF OPERATIONS	107
OPERATION BLOCK DIAGRAM	110
INDEX	112
SPECIFICATIONS	114

PRECAUTIONS

ROM PLAY

BASIC PROCEDURES

CONVENIENT PROCEDURES

FOR IMPROVED PERFORMANCE

APPENDIX

□ Main Features

- The SOUND Canvas is a multi-timbral sound module compatible with the General MIDI system, meaning that commercial song data (GM score) bearing the GM mark can be played. The SOUND Canvas is also a GS format sound module that is the common specification for Roland. Commercial song data bearing the GS mark can be played.
- The SOUND Canvas 354 sounds and 10 drum sets (including an SFX set).
- The SOUND Canvas can function as a complete 16-part multi-timbral sound module. The SOUND Canvas can play up to 28 notes simultaneously, and is thus appropriate as a sound module for sequencers and computer.
- By using the internal reverb and chorus effects, it is easy to reproduce the acoustic ambience of a concert hall.
- Connection to a computer is possible via single cable connected to the SC-55mkII's COMPUTER connector: no external MIDI interface is required. The SOUND Canvas also be used as a MIDI interface.
- With the User function, you can compare the original performance of song data with the performance in which the instrument settings have been changed.
- A "Minus One" play function is available that lets you temporarily mute a selected part of song data while you play that part yourself.
- A variety of system information, including the volume level of each part can be displayed in the large display screen.
- The SOUND Canvas comes complete with a remote control unit.
- Audio Input jacks are provided allowing you to mix the output of other sound modules with that of the SOUND Canvas. The signal of both units will be output from the Audio Output jacks.



General MIDI System

The General MIDI System is a set of recommendations which seek to provide a way for going beyond the limitations of proprietary designs, and standardize the MIDI capabilities provided by sound generating devices.

If you use a sound generating unit which carries the General MIDI logo (), you will be able to faithfully reproduce any song data which also carries the General MIDI logo.



GS Format

The GS Format is Roland's universal set of specifications which were formulated in the interest of standardizing the way in which sound generating devices will operate when MIDI is used for the performance of music. If you use a sound generating unit which carries the GS logo (), you will be able to faithfully reproduce any commercially available song data which also carries the GS logo.

This product supports both General MIDI and GS.

Song data which carries either of these logos can be accurately reproduced.

- * IBM and PC AT are registered trademarks of International Business Machines Corporation.
- * Apple is a registered trademark of Apple Computer, Inc.
- * Macintosh is a trademark of Apple Computer, Inc.

IMPORTANT NOTES

Be sure to use only the adaptor supplied with the unit. Use of any other power adaptor could result in damage, malfunction, or electric shock.

Power Supply

- When making any connections with other devices, always turn off the power to all equipment first; this will help prevent damage or malfunction.
- Do not use this unit on the same power circuit with any device that will generate line noise, such as a motor or variable lighting system.
- The power supply required for this unit is shown on its nameplate. Ensure that the line voltage of your installation meets this requirement.
- Avoid damaging the power cord; do not step on it, place heavy objects on it etc.
- When disconnecting the AC adaptor from the outlet, grasp the plug itself; never pull on the cord.
- If the unit is to remain unused for a long period of time, unplug the power cord.

Placement

- Do not subject the unit to temperature extremes (eg. direct sunlight in an enclosed vehicle). Avoid using or storing the unit in dusty or humid areas or areas that are subject to high vibration levels.
- Using the unit near power amplifiers (or other equipment containing large transformers) may induce hum.
- This unit may interfere with radio and television reception. Do not use this unit in the vicinity of such receivers.
- Do not expose this unit to temperature extremes (eg. direct sunlight in an enclosed vehicle can deform or discolor the unit) or install it near devices that radiate heat.

Maintenance

- For everyday cleaning wipe the unit with a soft, dry cloth (or one that has been slightly dampened with water). To remove stubborn dirt, use a mild, neutral detergent. Afterwards, be sure to wipe the unit thoroughly with a soft, dry cloth.
- Never use benzine, thinners, alcohol or solvents of any kind, to avoid the risk of discoloration and/or deformation.

Additional Precautions

- Protect the unit from strong impact.
- Do not allow objects or liquids of any kind to penetrate the unit. In the event of such an occurrence, discontinue use immediately. Contact qualified service personnel as soon as possible.
- Never strike or apply strong pressure to the display.
- A small amount of heat will radiate from the unit, and thus should be considered normal.
- Before using the unit in a foreign country, consult with qualified service personnel.
- Should a malfunction occur (or if you suspect there is a problem) discontinue use immediately. Contact qualified service personnel as soon as possible.
- To prevent the risk of electric shock, do not open the unit or its AC adaptor.

Memory Backup

- The unit contains a battery which maintains the contents of memory while the main power is off. The expected life of this battery is 5 years or more. However, to avoid the unexpected loss of memory data, it is strongly recommended that you change the battery every 5 years.
Please be aware that the actual life of the battery will depend on the physical environment (especially temperature) in which the unit is used. When it is time to change the battery, consult with qualified service personnel.
- When the battery becomes weak the following message will appear in the display: "Battery Low". Please change the battery as soon as possible to avoid the loss of memory data.
- Please be aware that the contents of memory may at times be lost; when the unit is sent for repairs or settings when by some chance a malfunction has occurred. Important data should be stored in another MIDI device (eg. a sequencer), or settings written down on paper. During repairs, due care is taken to avoid the loss of data. However, in certain cases, (such as when circuitry related to memory itself is out of order) we regret that it may be impossible to restore the data.

FRONT AND REAR PANELS

● Front Panel

PRECAUTIONS

● POWER switch

Press this button to turn the power on or off (standby) (☞P.7).

● Standby indicator

This indicator lights when the AC adaptor is connected and the Sound Canvas is in standby mode (power is off) (☞P.7).

● Volume control

This knob controls the volume of the output jacks and the headphone (PHONES) jack.

● Display (with bar display) (☞P.42, 44)

● INSTRUMENT buttons (☞P.18, 23)

● PAN buttons (☞P.19, 27)

● PART buttons (☞P.18)

● LEVEL buttons (☞P.19, 27)

● ALL button (☞P.30)

● MUTE button (☞P.30)

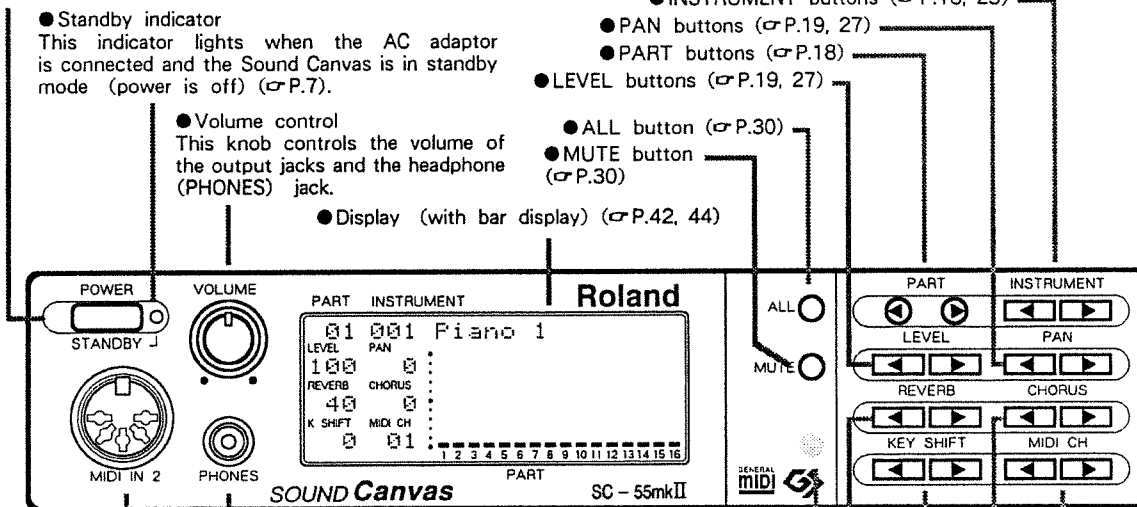

● Headphone jack (mini type)

A pair of stereo headphones can be connected to this jack. Even when headphones are used, sound will still be output from the Audio Output jacks (☞P.16).

● MIDI IN 2 connector

Messages received through this connector are combined with those received through the MIDI IN 1 connector on the rear panel (☞P.10, 35, 70).

● Remote sensor

The Sound Canvas receives signals from the Remote Control unit through this sensor (☞P.8).

● REVERB buttons (☞P.20)

● KEY SHIFT buttons (☞P.21)

● CHORUS buttons (☞P.20)

● MIDI Channel buttons (☞P.63, 76)

● Rear Panel

● Audio Input jacks

Audio signals from other devices are received through these jacks. The input signal will then be mixed with the audio signal of the Sound Canvas and will be output from the Audio Output jacks (☞P.11).

● Audio Output jacks (☞P.11)

● MIDI connectors (IN 1, OUT, THRU)

These connectors are for exchanging MIDI messages with other MIDI devices (☞P.10, 68, 70).

● Cable hook

By looping the AC adaptor cable around the cable hook, you can prevent the plug from accidentally being disconnected (☞P.16).

● AC adaptor jack

This jack is for connecting the included AC adaptor (☞P.16).

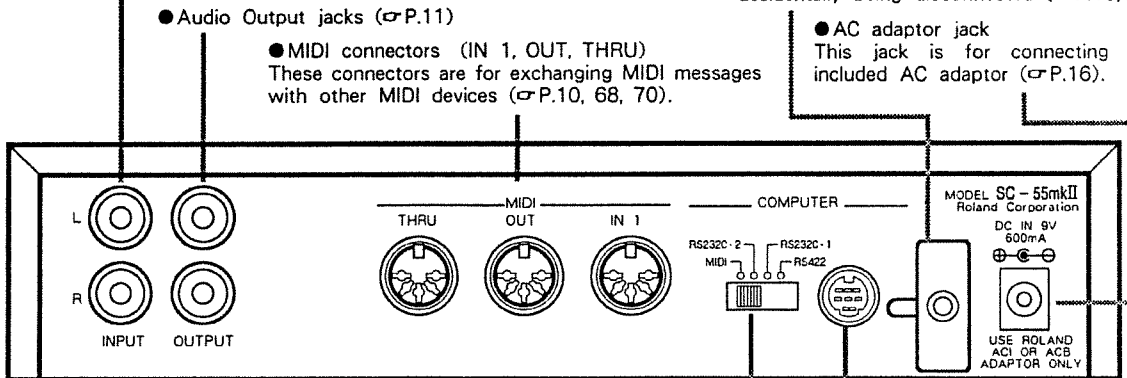

● RS422/RS232C-1/RS232C-2/MIDI (COMPUTER switch)

This multi-position switch selects a computer interface standard or the MIDI standard. This setting can be changed by the computer connected to the COMPUTER connector (☞P.12-14). Turn the power off before changing the position of the COMPUTER switch.

● COMPUTER connector

The optional computer cable is connected here. The computer cable will differ depending on the computer being used (☞P.12-13).

* MIDI THRU outputs the MIDI messages received at MIDI IN1.
The MIDI messages received at MIDI IN2 are not output.

TURNING THE POWER ON AND OFF

① Before you turn the power on, check the following points:

Is the supplied AC adaptor connected? (☞ P.15)

Is the SOUND Canvas correctly connected to the external devices? (☞ P.10 — 15)

Is the volume of the amplifier or sound system turned down?

② Turn the MIDI external devices and the SOUND Canvas on.

The STANDBY indicator of the SOUND Canvas will turn off and the display will show the following:

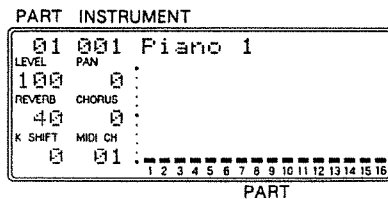

*The STANDBY indicator will be lit when the power is off (and the AC adaptor is connected).

③ Turn on your external audio equipment.

Adjust the volume of the amplifier or stereo system.

⇒The SOUND Canvas can be turned on/off with the rack's main power switch if the unit is set in a SYR - 4200/600 system rack (sold separately).

Caution: High volume levels can damage speakers. Ordinary audio speakers, as in a stereo system, are more sensitive than musical instrument amplification speakers. Take care when using ordinary audio speakers as sudden loud signals may damage them.

* Depending on the unit's location or the lighting conditions, the SOUND Canvas's display may not always be clearly visible. If such is the case, adjust the LCD contrast (☞ P.44).

< How to turn the power off >

① Before turning the power off, make sure that the volume of the amplifier is turned down.

② Power down in the following order:
Audio device → Sound Canvas and MIDI device

* Refer to P.37 for information about returning to the factory preset.

HOW TO USE THE REMOTE CONTROL

● Before using

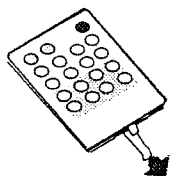

The remote control unit contains a lithium battery. An insulation sheet is inserted to prevent the battery from discharging. You must remove this insulation sheet before using the remote control. Grasp the tab and pull the sheet out.

● How to use the remote control

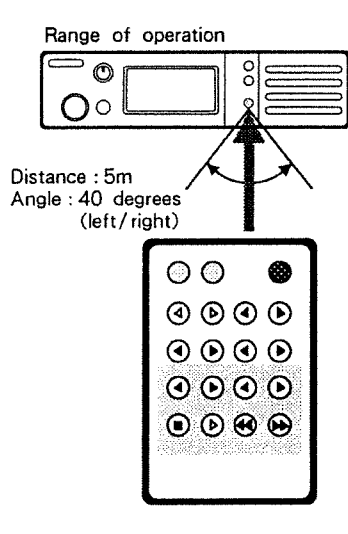

When using the remote control do not exceed the specified range of operation (5m). Always aim it towards the Remote Sensor on the front of the SOUND Canvas. The remote control can also be used to control the Sound Brush MIDI sequencer (SB - 55, sold separately).

Each button on the remote control has the following function:

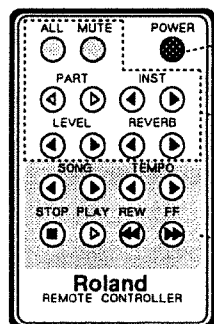

Power Button :
This button simultaneously controls the power for the Sound Canvas and the Sound Brush.

Sound Canvas Buttons :
These buttons duplicate the functions of the Sound Canvas's front panel buttons.

Sound Brush (SB-55) Buttons :
These buttons control various functions of the Sound Brush.

Note: The remote control is able to transmit only one button operation at a time. Therefore, you cannot select the ROM Play mode. To do so, use the buttons on the panel of the unit. (☞ P.17)

- * The remote control may not operate (even within the range of operation) if there is an obstacle between it and the main unit.
- * Using the remote control near other equipment that uses remote control systems may result in operational errors.
- * The life of the lithium battery depends on the amount (and conditions) of use. If after a while the operational range of the remote control decreases, change the battery.
- * If you will not be using the remote control for a long period of time, remove the battery.

< Using the SOUND Canvas together with the SB-55 Sound Brush Sequencer >

When you use the SOUND Canvas together with the Sound Brush sequencer, the remote control of the SOUND Canvas can turn the power to both units ON and OFF simultaneously. When you use the remote control with both units, be sure they are placed within the range of operation. When you want to control only one of the units, turn off the remote control receiving switch (☞ P.9) of the unit that you do not want to control.

- * When turning both units ON/OFF with the remote control, be sure that both units set to the same ON or OFF setting. If only one unit is ON when you begin, one unit will always be ON while the other is OFF.

● When you don't want to use the Remote Control (Setting the Remote Control reception switch)

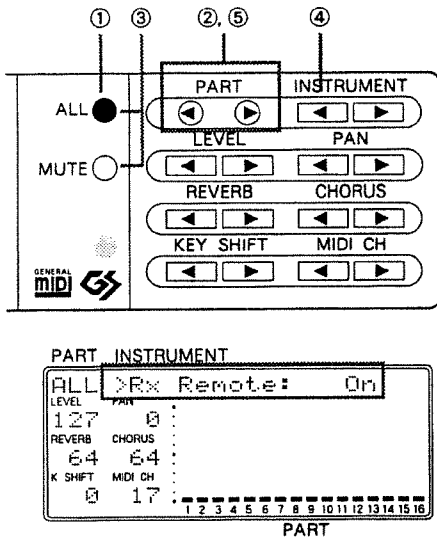

- ① Press **ALL** to turn the indicator light on.
If the indicator is already on, there is no need to press the button.
- ② Press the **PART** buttons (**◀** and **▶**) simultaneously.
- ③ Select "Rx Remote" with the **ALL** or **MUTE** button.
- ④ Press **INSTRUMENT** **◀** to turn the remote control receiving switch off.
Press **INSTRUMENT** **▶** to turn it back on.
- ⑤ After setting, press the **PART** buttons (**◀** and **▶**) simultaneously to finalize the setting.

● How to change the lithium battery.

- ① Insert a fingernail into the groove on the back of the remote control and pull out the battery holder.

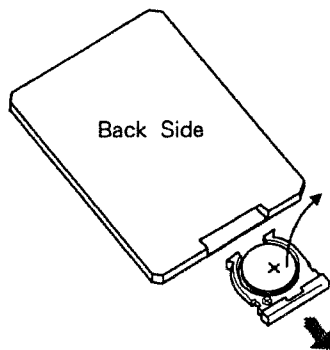

- ② Put the new lithium battery into the battery holder (positive "+" side up) and insert the battery holder back into the remote control.

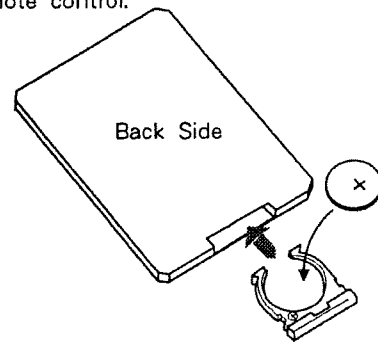

Note: Improper use of the lithium battery may cause leakage or explosion.

Observe the following precautions:

- Use only the specified lithium battery (CR 2025).
- Ensure the polarity is correctly set (positive "+" side up).
- Do not short circuit the battery, attempt to dismantle it, or throw it into a fire.

CONNECTIONS

● About the MIDI connectors

Different MIDI devices can be connected to the two MIDI IN connectors. For normal use, connect a sequencer (eg. the SB - 55 SOUND Brush) to the MIDI IN 1 connector.

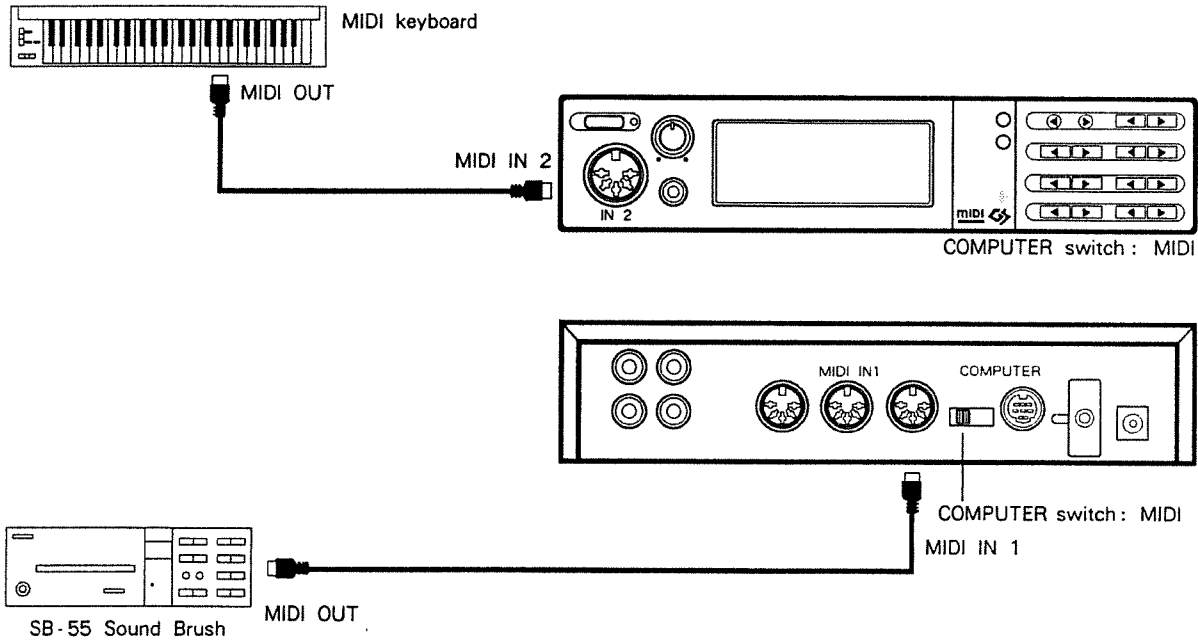

⇒The Roland SB - 55 SOUND Brush is a MIDI sequencer which can record and play standard MIDI song files. This means that it can not only play song data recorded with the SOUND Brush, but also the data recorded with other devices. This allows you to enjoy playing back music much as you would with a compact disc player.

● Audio Output connections

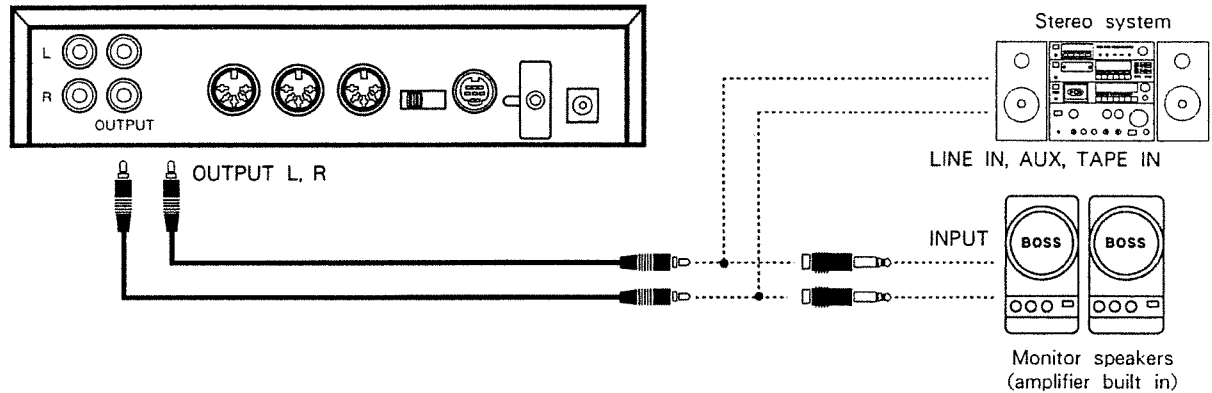

● Audio Input connections

The audio signals received through the Audio Input jacks will be mixed with the audio signals of the SOUND Canvas and output from the Audio Output jacks. This function is convenient when using another MIDI sound module or a radio - cassette recorder.

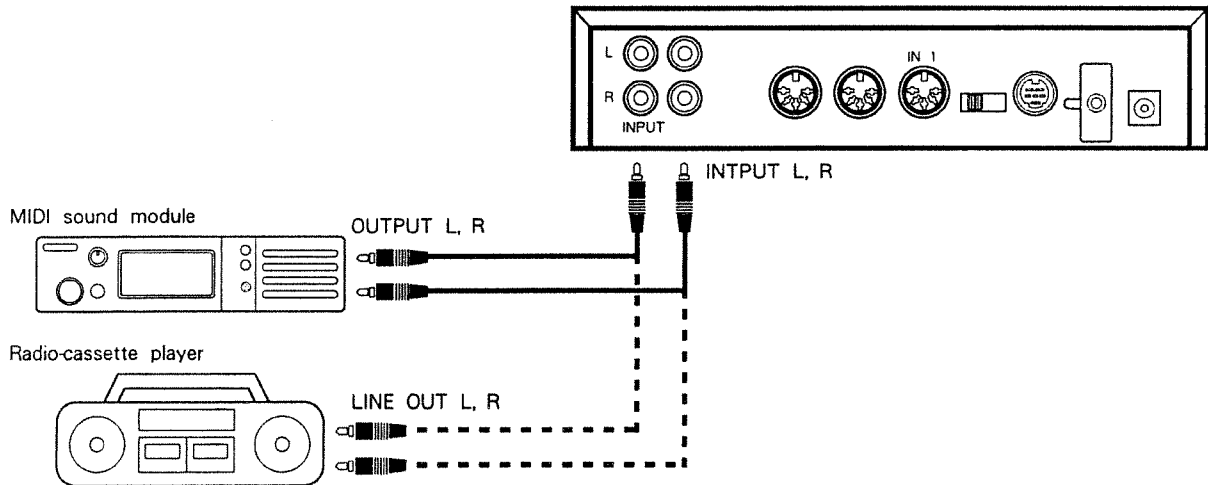

⇒The included audio cable is equipped with a 1/4" (Phono) plug adaptor on one end, and a standard RCA audio plug on the other end. If you remove the 1/4" (Phono) plug adaptor, both ends will have standard RCA audio plugs.



● Connecting with Apple Macintosh computers

Apple Macintosh computers and the SOUND Canvas can be connected with a computer cable (separately sold:RSC - 15APL).

- ① Turn the SOUND Canvas off, and set the select switch on the rear of the SOUND Canvas to RS422.

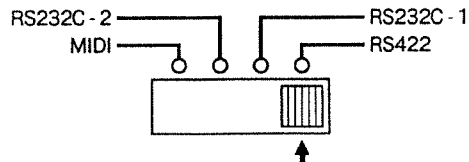

- ② Connect the computer cable to the modem port on the rear of the Macintosh computer.
- ③ Connect the other end of the computer cable to the SOUND Canvas COMPUTER port.

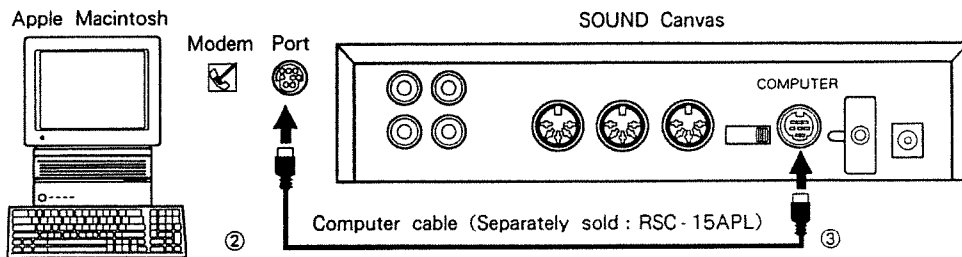

- ④ Turn the SOUND Canvas on.

◆ To use MIDI applications (software)

MIDI applications compatible with the Macintosh serial port can be used as they are. To use the application (with the SOUND Canvas connected), set the MIDI interface as shown below.

Specify the modem port (port to which the SOUND Canvas is connected) for the serial port.

Always set Interface Type (MIDI interface clock) to 1MHz.

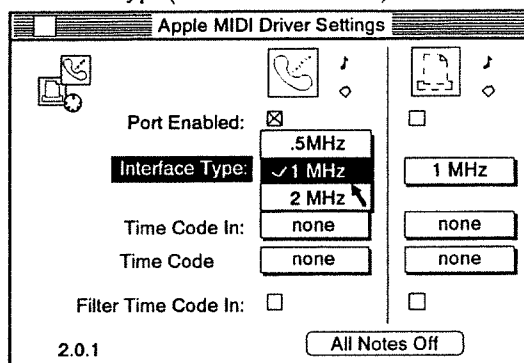

* The above screen shows the MIDI interface settings for the Apple MIDI driver.

● Connecting with IBM PC AT computers

PC AT computers and the SOUND Canvas can be connected with a computer cable (separately sold: RSC - 15AT).

PC AT computers two have one of serial ports: D - sub 25 pin or D - sub 9 pin. The RSC - 15AT computer cable (separately sold) is a 9 pin type connector. When you need a 25 pin type connector, study the "COMPUTER CABLE WIRING DIAGRAM" on page 83. This will help you purchase the appropriate cable.

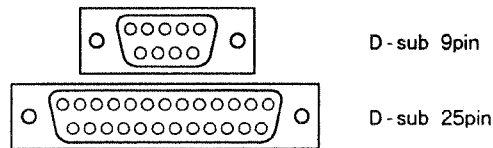

- ① Turn the SOUND Canvas off, and set the select switch on the rear of the SOUND Canvas to RS232C - 2.

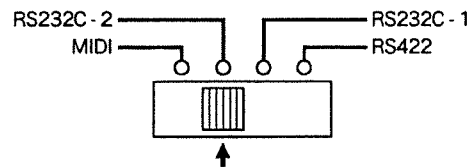

* The baud rate of the RS232C - 2 is 38.4K (bit/sec). Set the select switch to RS232C - 1 when using a MIDI application with a baud rate set to 31.25K (bit/sec).

- ② Connect the computer cable to the RS - 232C terminal on the rear of the PC AT computer.
- ③ Connect the other end of the computer cable to the SOUND Canvas COMPUTER port.

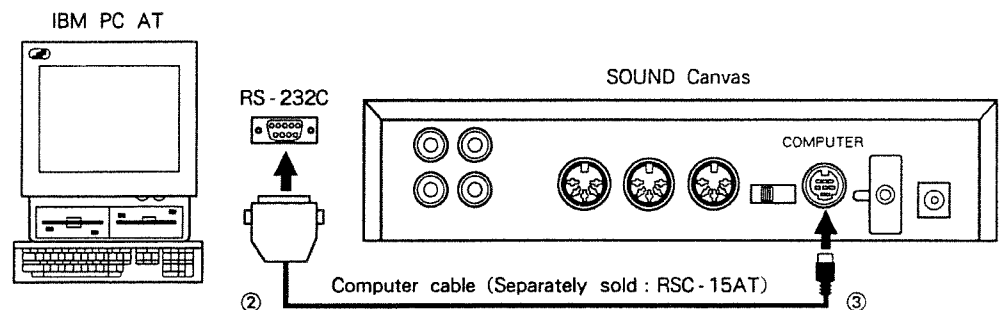

- ④ Turn the SOUND Canvas on.

◆ To use MIDI applications (software)

MIDI applications compatible with the MIDI interface (RS - 232C) can be used. To use the SOUND Canvas, set the computer so that its serial port can be used.

● How to use the COMPUTER switch

A dedicated terminal and switch (on the rear panel) sets the computer interface to allow the SC - 55mk II to be connected to various personal computers.

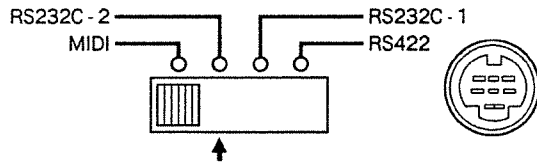

* The COMPUTER switch will be validated when the power is turned Off and then On after the setting has been made. Turn the power off before changing the position of the COMPUTER switch.

<MIDI Setting>

The computer terminal will be inactive when the COMPUTER switch is set to MIDI. Use the MIDI terminal to play the SOUND Canvas.

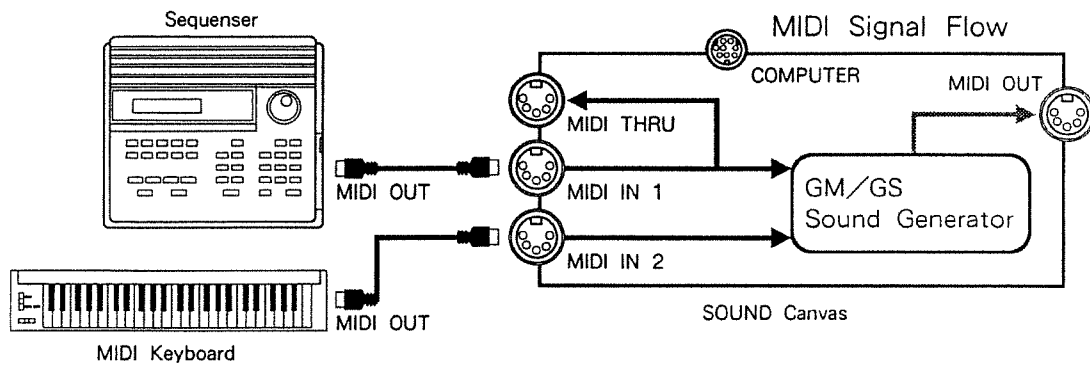

<Computer Setting>

Set to RS422, RS232C - 1 or RS232C - 2 according to the personal computer to be connected (☞ P.12—13).

The flow of MIDI signal is as shown below. The data received at MIDI IN1 is output to the computer with the factory preset settings. To output the data received at MIDI IN1 from the SOUND Canvas's MIDI OUT, soft - thru ★ must be ON (on the computer side). If soft - thru is not ON, the MIDI data received at MIDI IN1 cannot be played by the SOUND Canvas. The MIDI data received at MIDI IN2 can be played on the SOUND Canvas regardless of soft - thru setting.

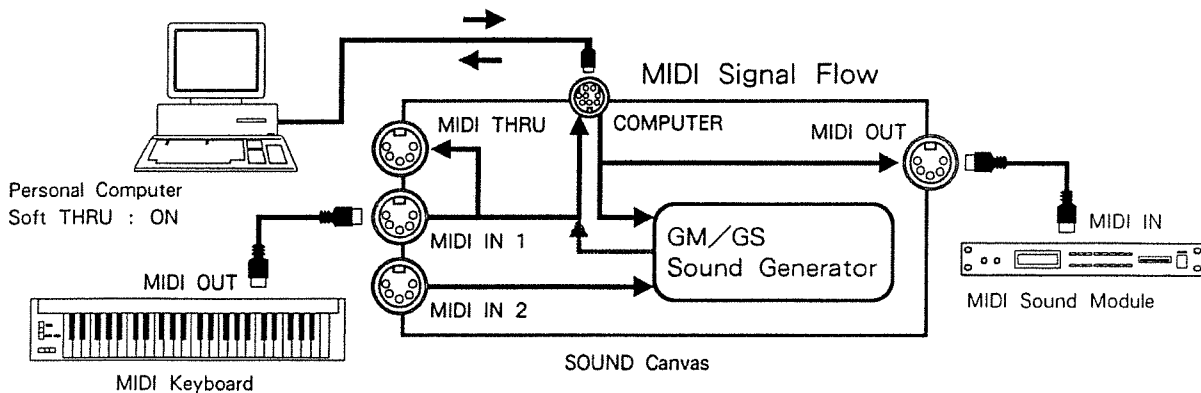

★Soft - thru is the function that outputs the received data in its original state.

*The MIDI IN1 and MIDI IN2 function can be reversed.(☞ P.35)

● Using headphones

Connect stereo headphones to the PHONES jack. For optimum performance, use headphones with an impedance from 8 to 150 ohms. Even when headphones are being used, sound will be output from the Audio Output jacks.

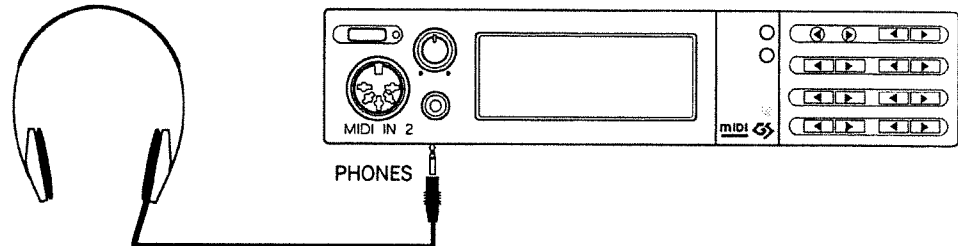

● Using the cord hook

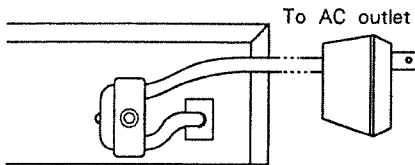

Connect the included AC adaptor to the SOUND Canvas, and then plug it into an AC outlet. By fixing the AC adaptor cable with the cable hook, you can prevent the plug from accidentally being disconnected.

Note: Please use only the included AC adaptor. Using other AC adaptors can result in malfunction or electric shock.

*When the AC adaptor is connected to the SOUND Canvas, the power will be on (standby mode).

● Installing the SOUND Canvas in a rack

Attach the SOUND Canvas to the RAD - 50 Rack Mount Adaptor (sold separately) as illustrated in the following diagram. Other half - rack size devices, such as the Sound Brush, can also be installed.

① With a screwdriver, carefully remove the four rubber feet from the bottom of the unit.

② Attach the RAD-50 adaptor to the SOUND Canvas using the screw holes located nearest the front of the unit, using the screws from the rubber feet. Do not re-attach the rubber feet.

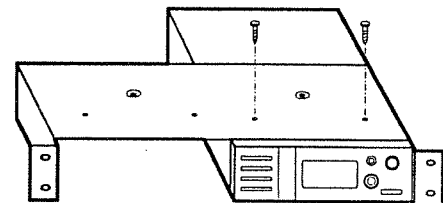
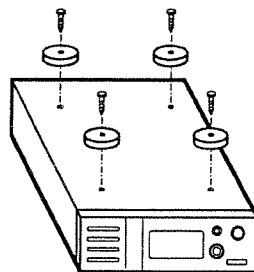

*When re - attaching the rubber feet to the unit, be sure to use the same screws that you used to attach the unit to the rack mount. Use of a different type of screw could result in damage or malfunction.

■ LISTENING TO THE DEMO SONGS - ROM PLAY

The SOUND Canvas contains four demonstration songs that highlight the unit's multi-timbral capability. The process of playing these demo songs is called ROM play.

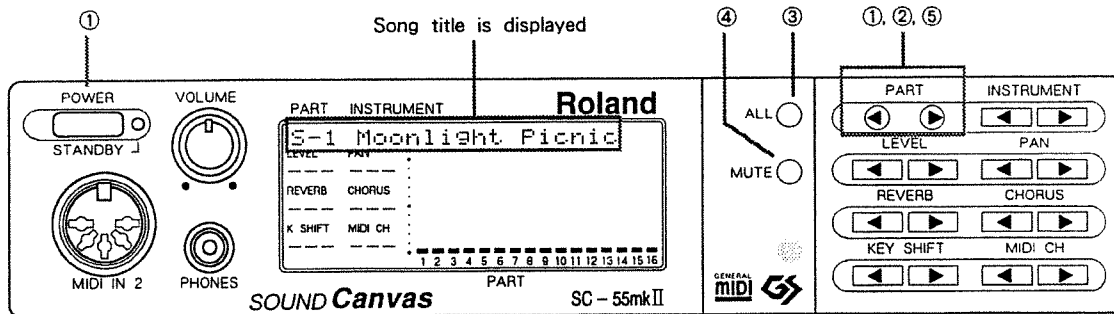

- ① While holding PART ◀ and ▶, turn the power on.
- ② Select a song with the PART ◀ ▶ buttons.

S-1	Moonlight Picnic	Music by John Campbell Copyright © 1993, Evanhale Music	S-3	Suplex Hold	Music by Mitsuru Sakaue Copyright © 1993, Roland
S-2	Low Flying	Music by Chas Smith Copyright © 1993, Roland UK	S-4	Monopoly	Music by Adrian Scott Copyright © 1993, by Adrian Scott

- ③ Press **ALL** to start Demo song playback.
The volume level of each instrument will be shown on the bar graph display.
Four songs will be played, beginning with the song you chose.
- ④ Press **MUTE** to stop playback.
- ⑤ Press PART ◀ and ▶ simultaneously to return to normal playing status.

* Operation ① and ⑤ cannot be performed with the remote control, so use the buttons on the panel.

* Performance data of the ROM demos is not output through the MIDI OUT connectors. Any incoming MIDI messages are ignored during the ROM performance.

<Composer Profile>

John Campbell

John Campbell is an award-winning Los Angeles, California based composer, keyboardist and producer. As a keyboard player, his long list of credits include working with artists such as Philip Bailey, Larry Carlton, Mel Torme, and the group "Chicago". As a composer, John has written music for a wide variety of television, film and radio projects. John has become a regular spokesperson for Roland Corporation combining his experience as a dynamic performing musician, composer, and educator.

Chas Smith

Roland UK's Senior Product Specialist/Demonstrator joined the company in 1987, after a free-lance career playing in rock bands. He is an active composer, principally for the jingle market. His particular interests lie in the use of the latest sampling technology, and in programming synthesizers.

Mitsuru Sakaue

Mitsuru Sakaue began composing and doing arrangements for commercials and videos while still in school. In particular, his studio work earned for him a solid reputation. Currently, he produces commercial musics and jingles for FM stations.

Adrian Scott

Adrian Scott formerly handled the vocals and keyboards for the popular group from Australia, "Air Supply". Since following the solo path, he in 1984 won the Silver Prize at the "World Song Festival Tokyo '84". Currently, he is involved as a producer of commercial music and music for films. In addition, as a session player, he has performed along with a number of Australia's top musicians, including John Farnham and Kylie Minogue. He lives in Melbourne, Australia.

PLAYING VARIOUS SOUNDS

The SOUND Canvas contains various special effect sounds (such as warble and telephone), as well as many musical instrument sounds (such as organ, piano, guitar, etc). Using these sounds, the SOUND Canvas can reproduce the performances of many types of music ranging from classical to rock to jazz. This manual refers these sounds as “Instruments” (☞ P.22).

⇒ Refer to the “Instrument Table” (☞ P.84) for a list of instruments contained in the SOUND Canvas.

⇒ The SOUND Canvas also contains 10 drum sets with various percussion instrument sounds (☞ P.24). For more details, refer to the “Drum set Table” (☞ P.88).

● How to select Instruments

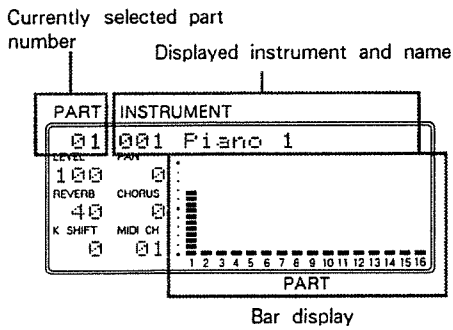

When a MIDI keyboard connected to the SOUND Canvas is played, the volume level of the selected instrument will be shown on the bar display.

- ① Before changing instruments, press **ALL** to turn the button indicator off.
- ② Play the sound, and using the **PART** buttons, select the part number that corresponds to the number on the bar display (showing the volume level).

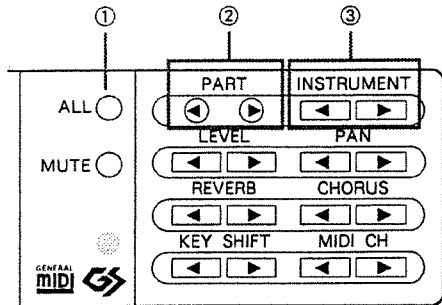

The name of the Instrument which is currently selected will be shown on the bar display.

- ③ Select a new instrument using the **INSTRUMENT** buttons.

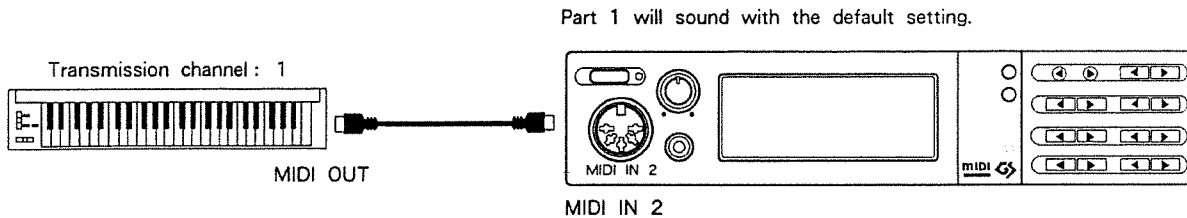

* The part of the reception channel that matches the MIDI keyboard transmission channel will sound.

CHANGING THE VOLUME LEVEL/PAN

The following explains how to set the correct volume level and make the necessary pan settings.

● Changing the volume level of ALL (0—127)

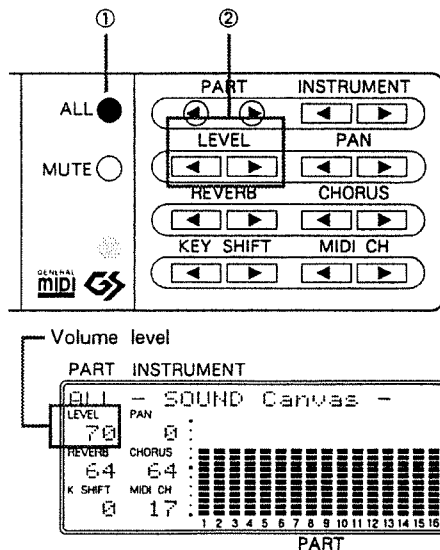

① Press **ALL** to turn the button indicator on.

② Use the **LEVEL** buttons to adjust the volume level.

The volume of all the parts will change.

⇒ When you press **LEVEL** and simultaneously, the current setting will be shown on the bar display.

Press **LEVEL** and again to return to the previous display.

⇒ You can adjust the overall volume level by using the volume control knob. However, if the volume control knob is turned all the way down, no sound will be heard, regardless of the adjustments made using the above procedure.

⇒ The volume level for each part can also be adjusted (☞ P.26).

● Changing the pan level of ALL (L63—0—R63)

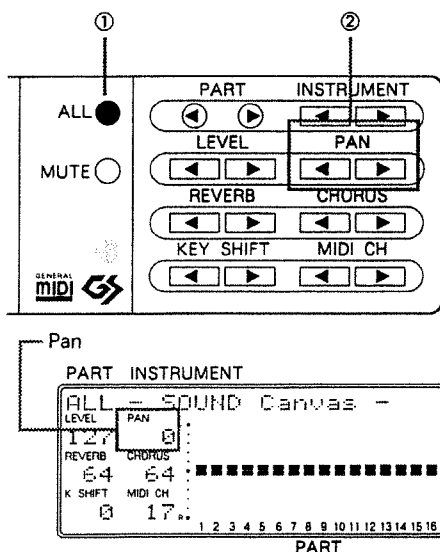

By changing the pan value, the position of where the sound is heard from the left/right speakers can be changed. ALL pan adjusts the stereo location of all sounds.

① Press **ALL** to turn the button indicator on.

② Use the **PAN** buttons to adjust the pan level.

“0” indicates that sounds will be heard equally from the left and right speakers. Higher “L” values indicate that more sound will be heard from the left speaker. Higher “R” values indicate that more sound will be heard from the right speaker.

⇒ When you press **PAN** and simultaneously, the current setting will be shown on the Bar display.

Press **PAN** and again to return to the previous display.

⇒ The pan setting can also be adjusted for each part (☞ P.26).

* Depending on the instrument, even if you position pan all the way to the left (or right) a small amount of sound might leak from the other speaker.

* The desired sound position may not be obtained when the SOUND Canvas is connected to a monaural audio system.

HOW TO ADJUST REVERB/CHORUS

Reverb and chorus effects can be added to enhance whatever you play. The following describes how to adjust the effect level. (☞ P.55)

● How to adjust the Reverb level (0—127)

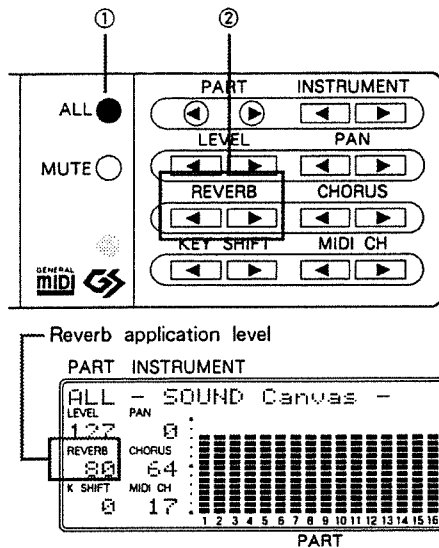

Reverb adds a spacious quality to the instrument sound. Listening to a sound containing Reverb is like listening in a concert hall. This adjustment determines how reverb is applied to the entire part.

- ① Press **ALL** to turn the button indicator on.
- ② Use the REVERB **◀▶** buttons to adjust the reverb level.
Higher values indicate higher levels of Reverb.

⇒When you press REVERB **◀▶** simultaneously, the current setting will be shown on the Bar display.

Press REVERB **◀▶** again to return to the previous display.

⇒The reverb effect for each part can be adjusted (☞ P.26).

● How to adjust the Chorus level (0—127)

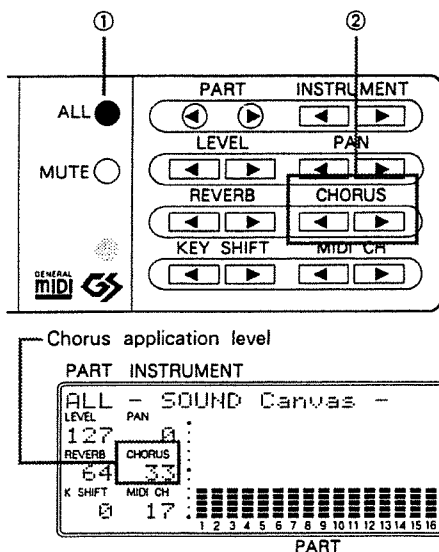

Chorus adds depth and warmth to the sound. This adjustment determines the level of the Chorus effect. Chorus is especially effective when used with instrument sounds such as organ, strings, etc.

- ① Press **ALL** to turn the button indicator on.
- ② Adjust the Chorus level using the CHORUS **◀▶** buttons.
Higher values indicate higher levels of Chorus.

⇒When you press CHORUS **◀▶** simultaneously, the current setting will be shown on the Bar display.

Press CHORUS **◀▶** again to return to the previous display.

⇒The chorus effect for each part can be adjusted (☞ P.27).

HOW TO TRANSPOSE ALL PARTS (KEY SHIFT)

Key shift is a function that changes the pitch of notes in semitone steps. For example: When using a sequencer to play the SOUND Canvas, you can play a different pitch without changing the settings of the sequencer.

● Transposing all parts (-24-0-+24 : in semitone steps, ±2 octaves)

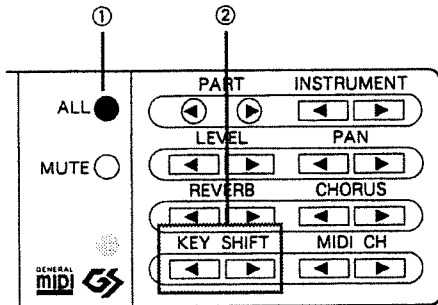

① Press **ALL** to turn the button indicator on.

② Set the amount of transposition with the **KEY SHIFT** **◀▶** buttons.

As the value increases (decreases) by 1, the pitch rises (falls) by one semitone. If the value increases (decreases) by 12, the pitch rises (falls) by one octave. A setting of "0" indicates standard pitch.

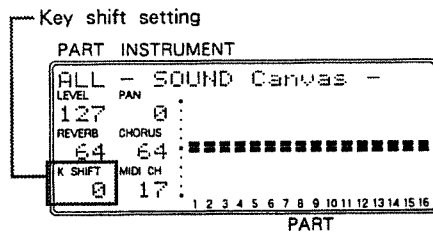

⇒When you press **K SHIFT** **◀** and **▶** simultaneously, the current setting will be shown on the Bar display.

Press **K SHIFT** **◀** and **▶** again to return to the previous display.

* The drum part (☞ P.24) pitch will not change with the above operations. To change the pitch of the drum part, follow the steps given on page 27 (key shift of parts).

⇒A different amount of transposition can be set for each part (☞ P.24).

SELECTING INSTRUMENTS

How to select an instrument for each part.

● Part, Instrument and MIDI channel

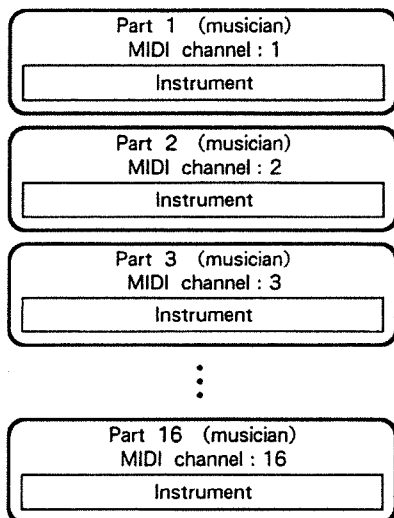

The following section briefly explains the relationship between a Part and an Instrument.

The SOUND Canvas has 16 parts, and a different instrument can be assigned to each. You can think of a Part as being a musician playing an instrument. In this way, the SOUND Canvas can be thought of as 16 musicians playing many different instruments together.

A sound module such as the SOUND Canvas is generally called a Multi-timbral sound module.

When using a MIDI device, these parts are identified as MIDI channels 1 to 16. (☞ P.69) A differing MIDI reception channel is set for each part at the factory (refer to the diagram to the left). To play the SOUND Canvas with a MIDI keyboard, the part of the channel that matches the MIDI transmit channel on the MIDI keyboard will sound. The part that is sounded will change when the MIDI channel is changed. If two parts are set to the same reception channel, the sounds will be layered (played together).

To play the 16 parts of the SOUND Canvas, use a MIDI device (i.e. sequencer) that can transmit multiple channels of playback data.

⇒For more details about MIDI refer to “About MIDI” (☞ P.68).

⇒When you want to change the MIDI channel of a part, refer to “Changing the MIDI receive channel” (☞ P.63).

< About the playable range of some instruments >

There are some notes that cannot be heard above or below a certain range (depending on the instrument). This is because the SC-55mk II's instruments are based on the actual playable range of the instrument being simulated.

● How to select Instruments

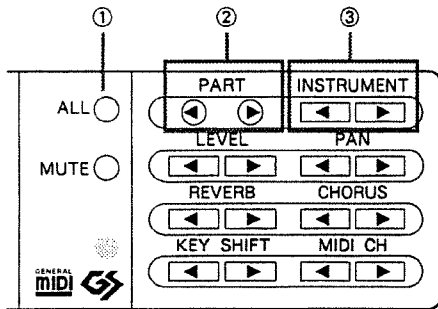

① Before selecting instruments, press **ALL** to turn the button indicator off.

② Select the part number using the **PART** **◀ ▶** buttons. The name of the current instrument will be shown in the display.

③ Press **INSTRUMENT** **◀ ▶** to select an instrument.

Currently selected part Instrument name and number of the displayed part

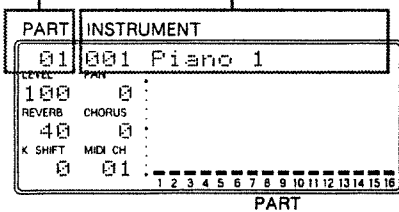

⇒ Part number 10 is preset for the drum part and its various percussion sounds. For further details about the drum part, refer to the next page.

⇒ The instrument variation can also be selected. (☞ P.45)

● How to select Instruments with Other MIDI devices

Part 1 (MIDI receive channel 1) will be changed to the instrument of program number 1.

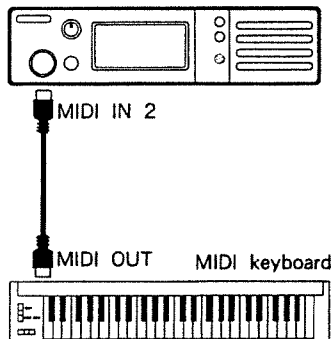

Transmitting program number 1 (MIDI transmit channel 1)

When you change instruments using a MIDI keyboard, the change information (Program Change message) will be transmitted from its MIDI OUT connector. When the message is received by the SOUND Canvas, the instrument of the specified part (with the same MIDI channel) will be changed.

The program number of the Program Change message determines which instrument will be selected. For example, if you select program number 1 on the MIDI keyboard, the SOUND Canvas will also be changed to the instrument of program number 1. Check the correspondence between the targeted instruments and the program numbers (☞ P.84).

⇒ The instrument variation can also be selected. (☞ P.45)

⇒ In the SOUND Canvas, the instrument number corresponds to the program number (☞ P.84).

⇒ Refer to the MIDI Keyboard Owner's Manual for the correspondence between each keyboard instrument and the program numbers.

⇒ If you do not want to change instruments with the other MIDI device, turn the instrument receiving switch of the SOUND Canvas off (☞ P.47).

■ HOW TO SELECT THE DRUM SET

Try out the sounds of the various percussion instruments.

● Drum Sets and the Drum Part

The SOUND Canvas contains 10 Drum Sets each consisting of various percussion sounds. Any one of these 10 sets can be selected for the Drum Part.

When you use a Drum Set, you must set a part to the Drum Part. Part 10 (MIDI receive channel 10) is the factory preset Drum Part. When you use part 10 for a Drum Set, set the MIDI transmit channel of the external MIDI device to 10. If you want the Drum Set to be heard without changing the MIDI transmit channel of the external MIDI device, set the part of the channel that matches the transmit channel to the Drum Part. (☞ P.25)

⇒ When using a sequencer, adjust the note number of the rhythm data beforehand to the note number of the drum set (☞ P.88) that you are using.

● How to select a drum

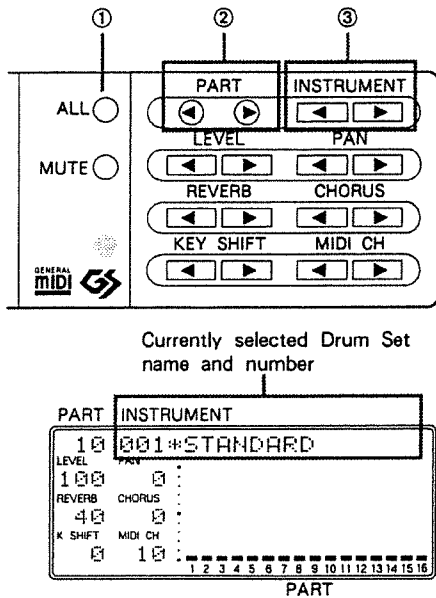

- ① Press **ALL** to turn the button indicator off.
- ② Select part 10 using the **PART** **◀▶** buttons.
- ③ Select a Drum Set with the **INSTRUMENT** **◀▶** buttons.
- ④ If your MIDI keyboard is connected, you can hear the various percussion instrument sounds by pressing the keys. (There are some keys that do not have sounds assigned to them.)

⇒ Refer to the "Drum Set Table" (☞ P.88) for a list of each Drum Set's percussion instruments.

⇒ When you select the Drum Part, a "*" mark will appear before the Drum Set name. This will enable you to quickly check which part is set to the Drum Part.

● How to select the Drum Set with MIDI messages

You can change the Drum Set, as well as the instruments, with Program Change messages sent by another MIDI device (☞ P.71). The Drum Set numbers corresponds with the MIDI program numbers (☞ P.88).

⇒ If you do not want to change the Drum Set by MIDI messages, turn the instrument receiving switch of the SOUND Canvas off (☞ P.47).

● Changing the Drum Part number

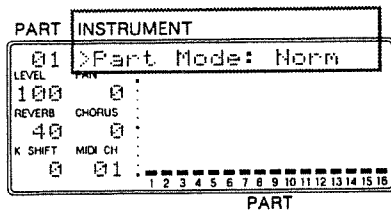
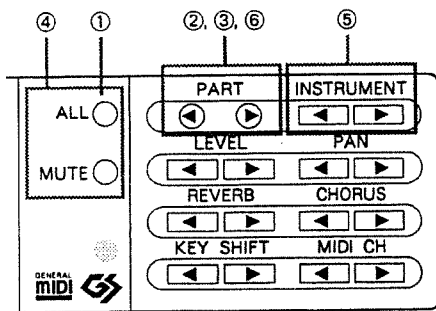

- ① Press **ALL** to turn the button indicator off.
- ② Select the part number that you want to assign as the Drum Part using the PART **◀▶** buttons.
- ③ Press PART **◀▶** simultaneously.
- ④ Use the **ALL** and **MUTE** buttons to select "Part Mode".
- ⑤ Select "Drum 1" or "Drum 2" using the INSTRUMENT **◀▶** buttons.
Select "Norm" to return to the regular part (Normal Part).
- ⑥ After setting, press PART **◀▶** simultaneously to finalize.

* Multiple parts can be set as Drum Parts, but only Drum 1 and Drum 2 can be used simultaneously. For example, if the Drum Part is set as shown below, and the part 1 Drum Set is changed, part 3 will change to the same Drum Set.

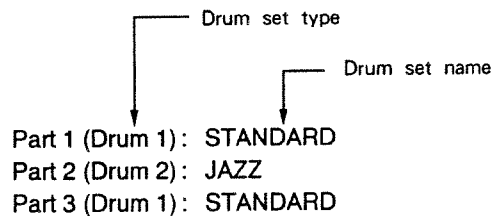

PART SETTINGS

You can set the volume level, pan, reverb, chorus and key shift for each part. Consider the balance of each part when making the settings.

● LEVEL (volume level) : 0—127

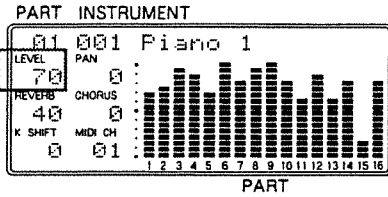

Adjusting the volume level of each part.

Use the LEVEL ◀▶ buttons to adjust the volume level. Higher values indicate higher volume levels.

⇒The volume level of all the parts can also be adjusted (☞ P.19).

● PAN : Rnd, L63—0—R63

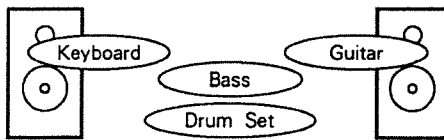
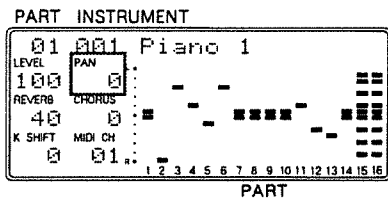

The pan setting of each part determines the stereo location of each instrument. One example of pan setting is shown in the illustration. The bass and Drum Set are in the center, while the keyboard is on the left side and the guitar is on the right side.

Use the PAN ◀▶ buttons to set pan levels.

“0” indicates a central stereo location. Higher “L” values indicate that more sound will be heard from the left speaker. Higher “R” values indicate that more sound will be heard from the right speaker. When “Rnd (random)” is selected, the sound will be moved to a different stereo location every time the instrument is heard. This random panning creates a unique effect.

⇒The Drum Set has a preset stereo location for each percussion sound. If you change the pan level of the Drum Part, the stereo location of the entire Drum Set will be moved.

⇒The pan of all the parts can also be adjusted (☞ P.19).

* Depending on to the instrument, even if you position pan all the way to the left (or right) a small amount of sound might “leak” from the other speaker.

* The desired sound effect may not be achieved when the SOUND Canvas is connected to a monaural audio system.

● REVERB : 0—127

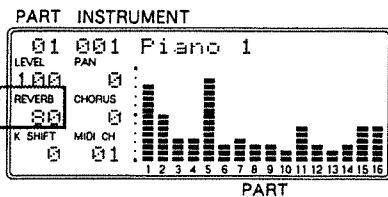

Use the REVERB ◀▶ buttons to adjust the reverb level.

Higher values indicate higher levels of reverb.

* If the reverb level (☞ P.20) of all parts is low, the effect will be difficult to hear.

● CHORUS : 0—127

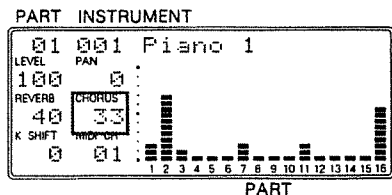

Use the CHORUS buttons to adjust the chorus application.

Higher values indicate higher levels of chorus.

* If the chorus level (P.20) of all parts is low, the effect will be difficult to hear.

● KEY SHIFT : - 24—0—+ 24 in semitones steps, ± 2 octaves

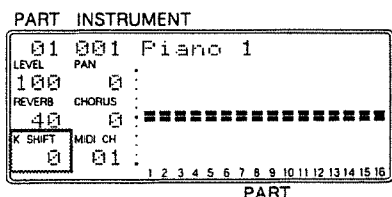

Use the key shift function when you want to transpose a specific part. Perform the operation given on page 21 to transpose the all parts simultaneously.

Use the KEY SHIFT buttons to set the amount of key shift.

As the value increases (decreases) by 1, the pitch rises (falls) by one semitone. As the value increases (decreases) by 12, the pitch rises (falls) by one octave. A setting of “0” indicates standard pitch.

□ How to set

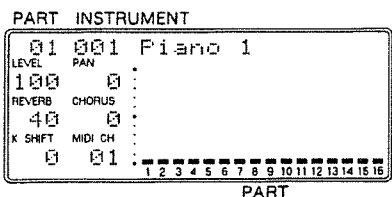
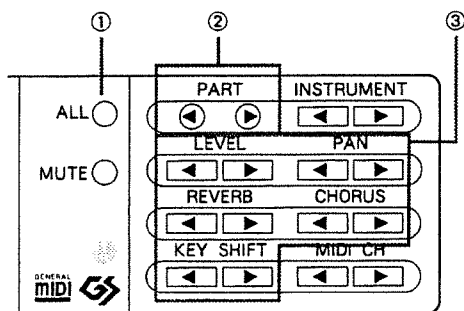

① Make sure that the **ALL** indicator is off. If the indicator is on, press the button to turn it off.

② Use the the PART buttons to select the part that you want to make a setting for.

Each setting of the current part will be shown on the display.

③ Use the following buttons to set each function:

LEVEL : Volume level

PAN : Pan

REVERB : Reverb

CHORUS : Chorus

KEY SHIFT : Key shift

⇒ When you press and of a specified function simultaneously, the setting of each part will be shown on the bar display. Press and of the specified function simultaneously again to return to the previous display.

THE USER (COMPARE) FUNCTION

While the SOUND Canvas is playing back music data, you can easily replace any Instrument with any other Instrument. This allows you to "create" your own ensemble (different from that in the original music data).

The USER Function allows you to retain this new ensemble in memory. Thus you can compare your new ensemble with the original one in the music data.

The settings that can be retained in "USER" are Instrument, Volume and Pan value.

● Changing the setting of "USER"

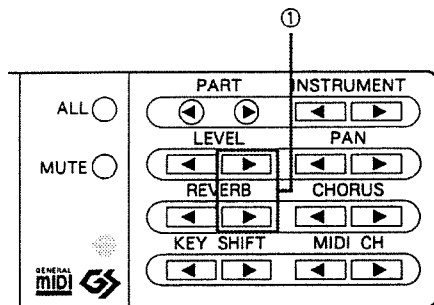

- ① Press LEVEL and REVERB simultaneously to select "USER".

The display will respond with the current "USER" settings.

The bar display will be highlighted. (For example, Type 5 is displayed when Type 1 is selected as the display method (P.42), and Type 6 when Type 2 is selected.)

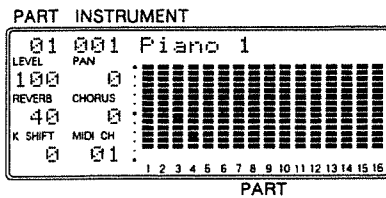

- ② Select the Instrument (plus Volume and Pan) for each Part.

Playback of the original song data Instruments ("USER" OFF) can be heard by again pressing LEVEL and REVERB simultaneously.

Thus you can compare the "USER" setting with original one.

⇒ The settings you make for the "USER" function will not change, even if the original song data contains "change" messages (for Instrument, Volume, Pan). This will ensure that your new ensemble remains as set.

* The settings of Total Volume and Total Pan cannot be stored in the "USER".

* The settings of both "USER" ON and "USER" OFF will be initialized to the preset values when "Init All" is executed (P. 37).

* When the power is turned on, the "USER" will always be set to OFF.

● Clearing the setting of "USER"

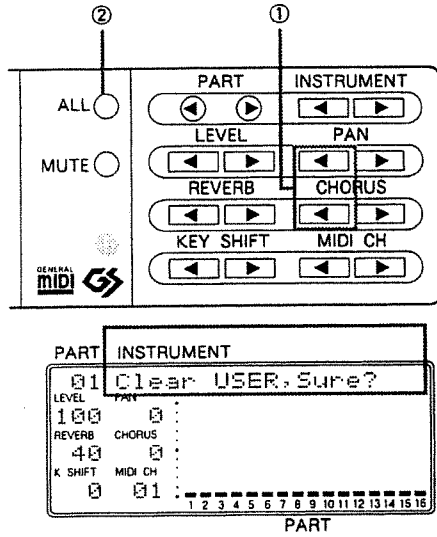

When you use the "USER" Function with new song data, it is convenient to first clear the "USER" ON settings so that they will be identical to those of "USER" OFF. This will ensure that noting changes when you select the "USER" function.

- ① Press PAN and CHORUS simultaneously.

The display will read, "Clear USER, Sure?".
(Press MUTE to cancel the procedure.)

- ② When **ALL** is pressed, the settings of "USER" OFF will be copied to "USER".

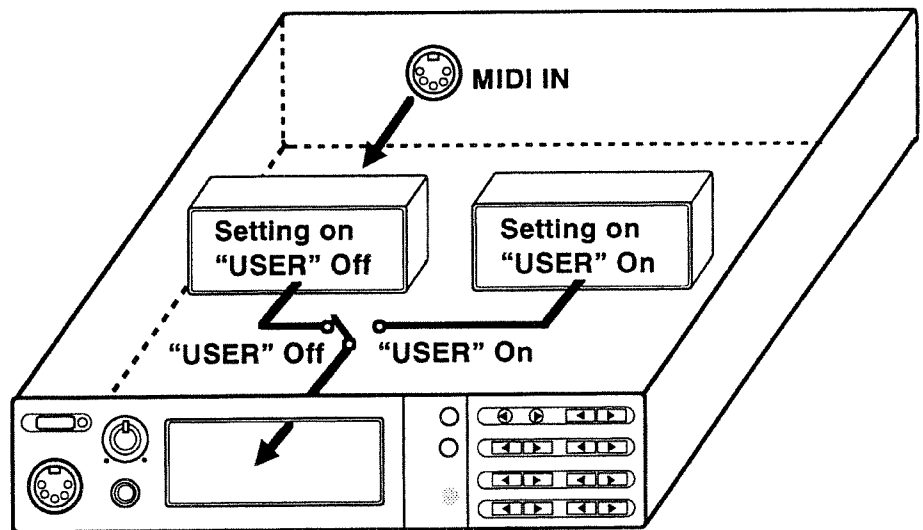

MUTE

Mute is a function that temporarily mutes the sound of a part ; “ALL mute” temporarily mutes the sound of all parts and “PART mute” temporarily mutes the sound of a specified part. The Mute function is used when you don’t want sound (ALL or PART) to be heard for a moment.

● Mute all parts (ALL mute)

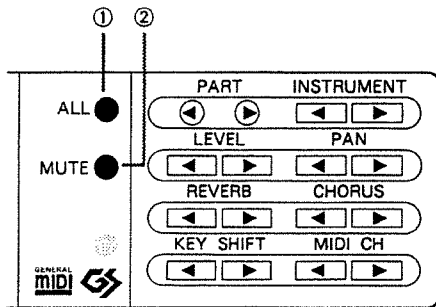

① Press **ALL** to turn the button indicator on.

② Press **MUTE** to turn “ALL mute” ON.

When ALL mute is ON, the button indicator will be lit.

Press the button again to turn the ALL mute OFF.

⇒ You can determine if the mute of each part is ON/OFF by means of the segment at the bottom of the bar display.

When ALL mute is ON, all part segments will be off.

● Mute a specified part (PART mute)

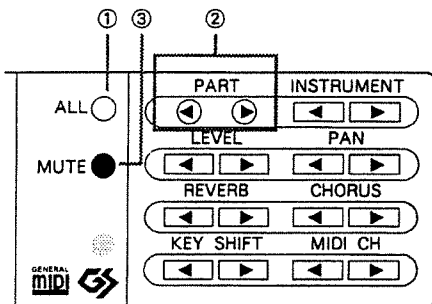

① Press **ALL** to turn the button indicator off.

② Use the **PART** buttons to select the part that you want to mute.

③ Press **MUTE** to turn “PART mute” ON.

When PART mute is ON, the button indicator will be lit.

Press the button again to turn PART mute OFF.

⇒ The **MUTE** indicator will be lit only when the muted part is selected.

⇒ You can determine if the mute of each part is ON/OFF by means of the segment at the bottom of the bar display.

The segment of a part that is muted will be OFF.

*When “ALL mute” is ON, the segments at the bottom of the bar display will all be off, whether “PART mute” is on or off.

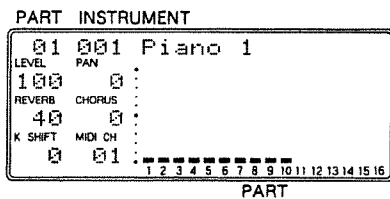

● Avoiding cancellation of the mute setting even when a GM system On/GS reset message is received (Mute Lock)

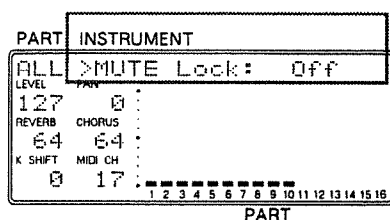
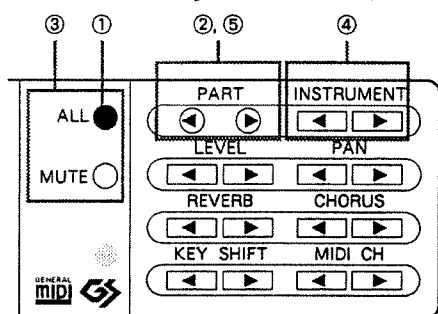

Mute settings you have made during playback may only be effective for the current playback of song data. This is because of a message recorded at the beginning of the song which resets the SOUND Canvas to the GM system on basic settings of GS (GM system On/GS reset, P.75).

There may be occasions, however, when you wish to cancel this reset message. This would make it unnecessary to reset the mute every time you play the song data from the beginning. For example, this is handy for muting a specific part while you practise that part repeatedly.

- ① Press **ALL** to turn the indicator on.
- ② Press the **PART** buttons (**◀** and **▶**) simultaneously.
- ③ Use the **ALL** and **MUTE** buttons to select "MUTE Lock".
- ④ Turn it ON by pressing the **INSTRUMENT ▶** button.
Press the **INSTRUMENT ◀** button to turn it OFF.
- ⑤ After the setting is done, complete the operation by pressing the **PART** buttons (**◀** and **▶**) simultaneously.

CONVENIENT PROCEDURES

■ MONITORING THE SOUND OF A PART

The monitor function is used to listen to a specific part sound. Part Monitor monitors only a specified part sound, while All Monitor monitors the sound of all parts.

When you are playing back an ensemble performance with a sequencer, etc., Part Monitor is used to monitor the performance of one part. When some parts are muted by Part Mute (☞ P.30), All Monitor is used to monitor the sound of all parts for a short while.

● Monitoring the sound of a part (Part Monitor)

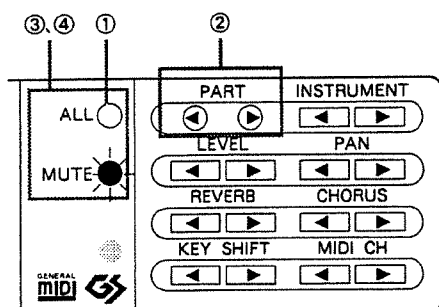

- ① Press **ALL** to turn the button indicator off.
- ② Use **PART** ◀ and ▶ to select the part that you want to monitor.
- ③ Press **ALL** and **MUTE** simultaneously.
The **MUTE** indicator will blink. Only the current part can be monitored in this situation.

⇒ If you change parts in the monitor status, the sound of the part that you selected can be monitored (even if you select a part that is muted by Part Mute).

- ④ Press **ALL** and **MUTE** simultaneously again to return to the previous status.

● Monitoring the sound of all parts (All Monitor)

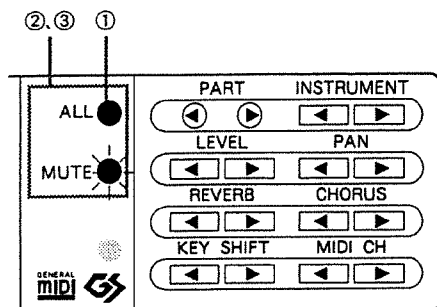

- ① Press **ALL** to turn the button indicator on.
- ② Press **ALL** and **MUTE** simultaneously.
The **MUTE** indicator will blink. The sound of all parts can be monitored in this status regardless of the setting of Part Mute.
- ③ Press **ALL** and **MUTE** simultaneously again to return to the previous status.

SETTING TO THE PITCH OF ANOTHER INSTRUMENT (MASTER TUNING)

Adjust Master Tune when you want to adjust the SOUND Canvas's pitch to match that of another instrument. Use Fine Tune to adjust the tuning of each part.

● Master Tune : 415.3—466.2Hz

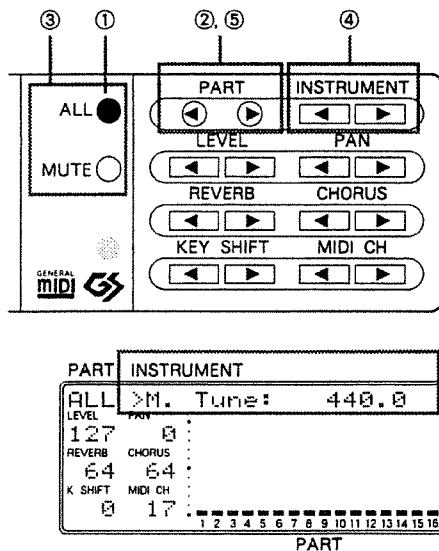

- ① Press **ALL** to turn the button indicator on.
- ② Press the PART buttons (**◀** and **▶**) simultaneously.
- ③ Use the **ALL** and **MUTE** buttons to select "M.Tune".
- ④ Use the INSTRUMENT **◀▶** buttons to adjust the pitch.
The displayed value (440.0) is the frequency of A4 on a keyboard.
- ⑤ After tuning, complete the operation by pressing the PART buttons (**◀** and **▶**) simultaneously.

● Fine Tune : - 12.0~ + 12.0Hz

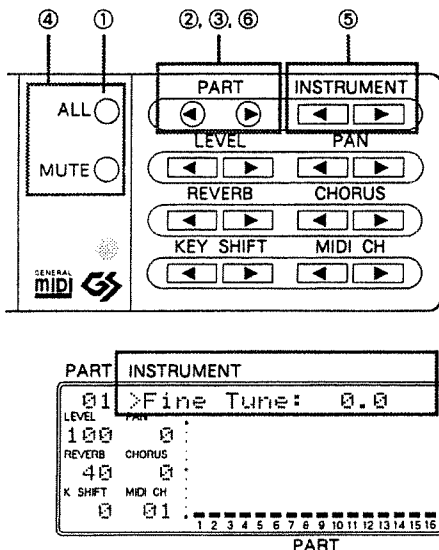

- ① Press **ALL** to turn the button indicator off.
- ② Press the PART buttons (**◀** and **▶**) simultaneously.
- ③ Select the Part to be tuned using the PART **◀▶** buttons.
- ④ Use the **ALL** and **MUTE** buttons to select "Fine Tune".
- ⑤ Use the INSTRUMENT **◀▶** buttons to adjust the pitch.
The value shown indicates (0.0) the difference from the master tune setting.
- ⑥ After tuning, complete the operation by pressing the PART buttons (**◀** and **▶**) simultaneously.

MINUS - ONE PLAY

Playing the SOUND Canvas with a sequencer but playing one part of the song by yourself is called "Minus - one" play. Minus - one play can be enjoyed with commercial music data or original song data.

Minus - one play can be accomplished by muting the part that you are to play yourself (☞ P. 30). However, if the part that you are to play is not available on the SOUND Canvas, (e.g. the part is muted), the part that you are playing cannot be sounded from the SOUND Canvas. In this case, use the Minus - one play function. When the minus - one play function is used, the muted part can be sounded from the MIDI keyboard.

* The terminal for connecting the MIDI keyboard for Minus - one play is set to MIDI IN2 when the SOUND Canvas is shipped from the factory. This can be changed to MIDI IN1 (☞ P.35).

● How to use Minus - one play

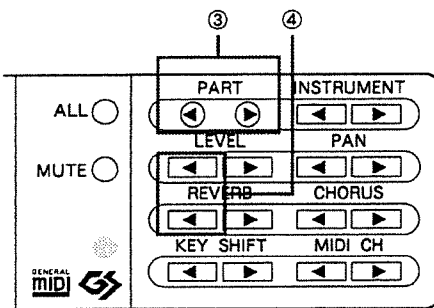

Mark when minus-one function is on

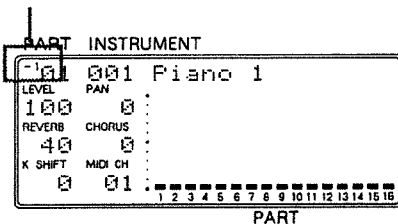

- ① Connect the MIDI OUT of the sequencer to MIDI IN1 on the SOUND Canvas.

Connect the MIDI OUT of the MIDI keyboard to MIDI IN2 of the SOUND Canvas.

- ② Press **ALL** to turn off the indicator.

- ③ Display the part to be muted by using the PART buttons.

- ④ Press the LEVEL and REVERB buttons simultaneously, and turn on the Minus - one function. " - 1" will be displayed to the left of the displayed part number.

- ⑤ Start playing with the sequencer.

* The muted part can be played no matter when the MIDI keyboard transmit channel is if the Minus - one function is turned on.

- ⑥ Press the LEVEL and REVERB buttons simultaneously to turn the Minus - one function off.

● Interchanging the MIDI IN1 and IN2 functions

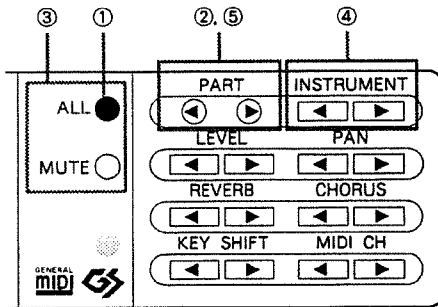

When using the Minus - one function with the factory settings, the MIDI keyboard is connected to MIDI IN2 on the SOUND Canvas. To use the Minus - one function with the MIDI keyboard connected to MIDI IN1 on the SOUND Canvas, set the IN1 ↔ IN2 switch on. When turned on, the MIDI IN1 and IN2 functions will be interchanged.

* The IN1 ↔ IN2 switch will be validated when the power is turned Off and then On after the setting has been made.

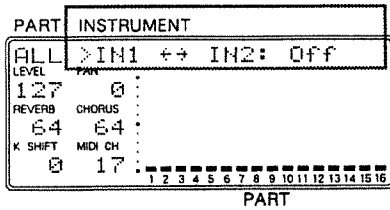

- ① Press **ALL** and turn off the indicator.
- ② Press the **PART** buttons simultaneously.
- ③ Select "IN1 ↔ IN2" with **ALL** **MUTE**.
- ④ Press **INSTRUMENT** , and turn "On".
- ⑤ The operation is completed by pressing **PART** simultaneously.

< Connecting when IN1 ↔ IN2 : Off >

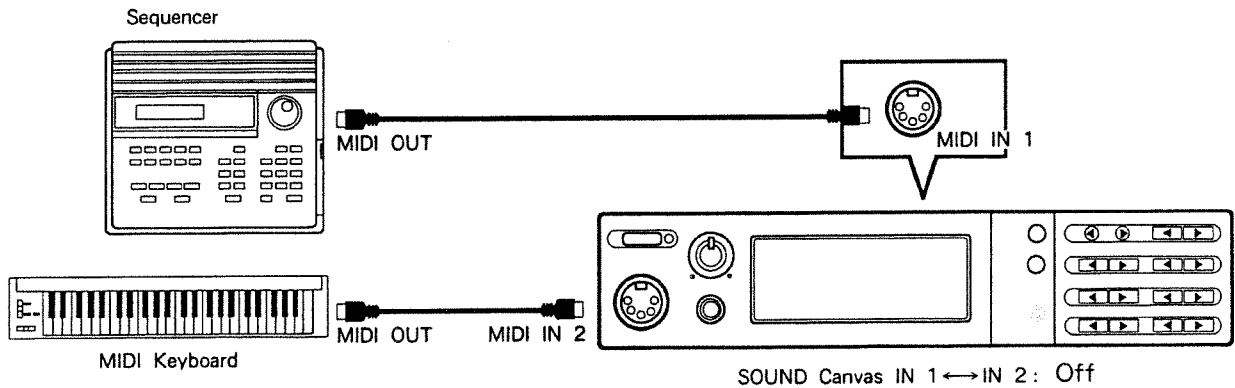

< Connecting when IN1 ↔ IN2 : On >

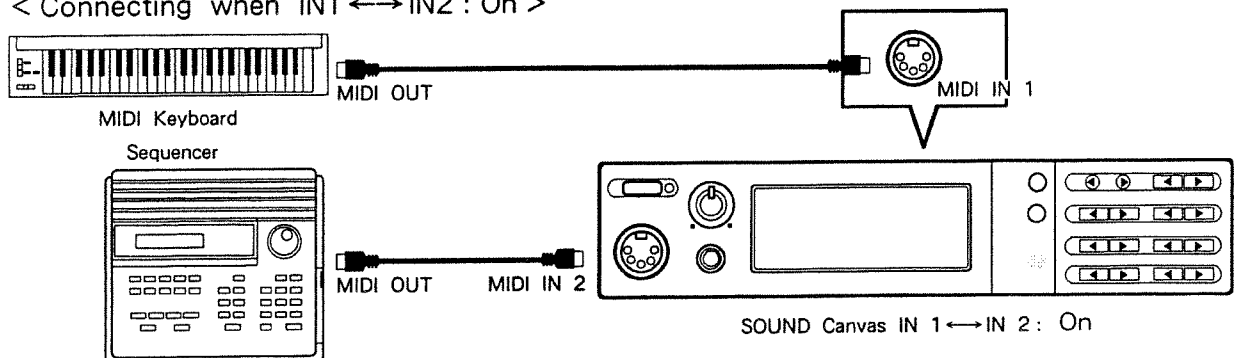

INITIALIZATION FOR GM/GS

Initialization for GM/GS must be performed to play song data that carries the GM/GS mark. The GM/GS initial settings will be set when initialized, so song data with the GM/GS mark can be played. Song data with the GM/GS mark contains GM System On and GS reset data (☞ P.75) at the beginning. Therefore, initialization will be performed automatically when the song data is played from the beginning, and initialization with the button operation is not required.

The system function (☞ P.107) settings and user data (☞ P.28, 41) will not change even when initialization for GM/GS is performed.

● Initialization for GM

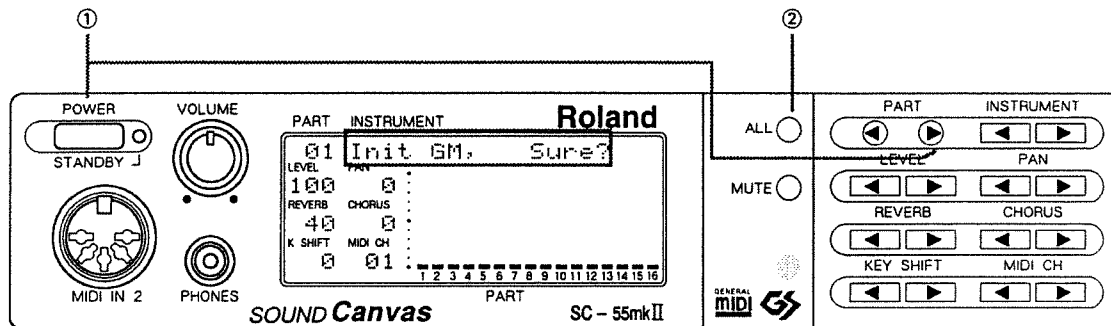

① Turn the power ON while holding PART .
"Init GM, Sure?" will be displayed.

② Press **ALL**. (Press **MUTE** to stop the operation.)

Note: The GM basic settings will be set even if the back up switch (☞ P.37) is turned on.

● Initialization for GS

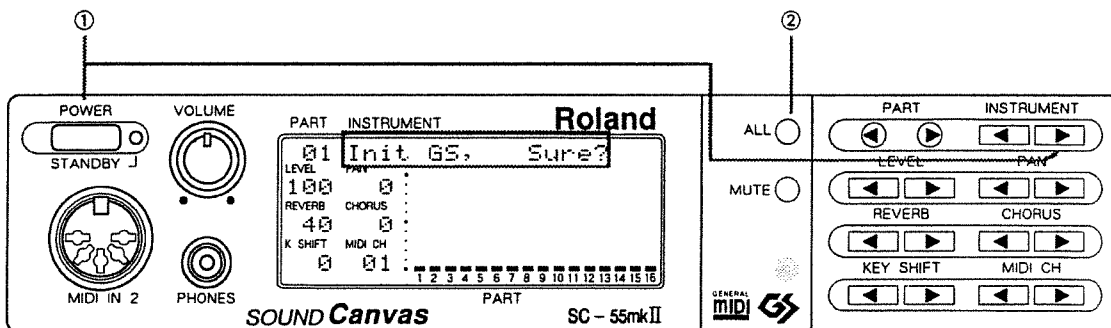

① Turn the power ON while holding INSTRUMENT .
"Init GS, Sure?" will be displayed.

② Press **ALL**. (Press **MUTE** to stop the operation.)

Note: The GS basic settings will be set even if the back up switch (☞ P.37) is turned on.

RETURNING TO FACTORY PRESETS

● To initialize all settings

Initialization is performed with the following procedure to set the SOUND Canvas to the original factory settings. The system functions (☞ P.107) and user data (☞ P.28, 41) will also be returned to the factory settings when this initialization is performed.

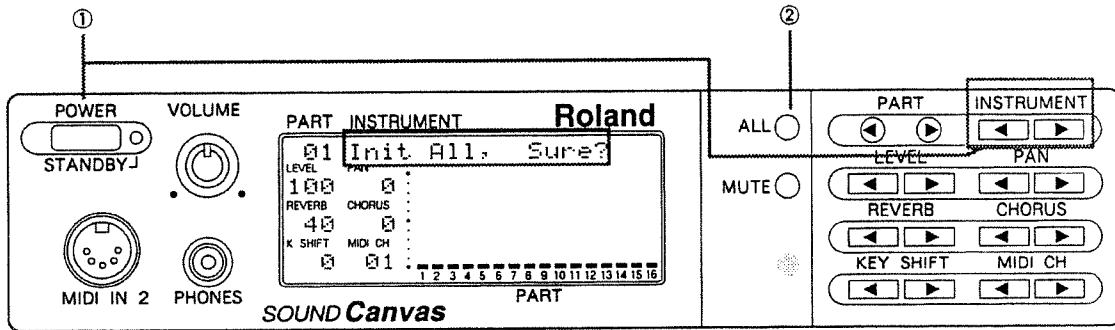

- ① Turn the power ON while holding INSTRUMENT and .
- “Init All, Sure?” will be displayed.
- ② Press . (Press to cancel the operation.)

How to use the backup switch

The backup switch (when on) ensures that the last used settings will be displayed upon power up.

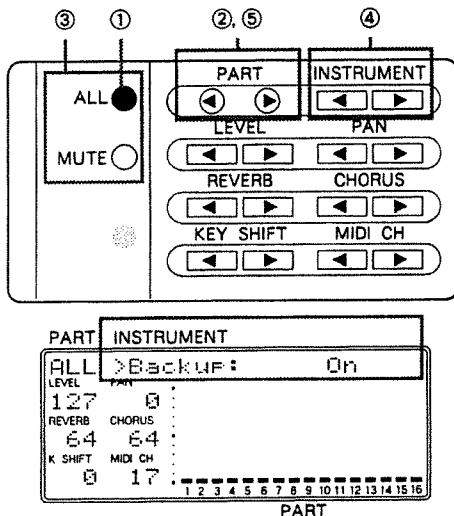

* The system function (☞ P.107) settings and user data (☞ P.28, 41) will be saved even if the backup switch is turned off.

- ① Press and the button indicator will light.
- ② Press the PART and buttons simultaneously.
- ③ Select “Backup” with .
- ④ Press INSTRUMENT to turn the switch “Off”. To turn it “On”, press INSTRUMENT .
- ⑤ After completing the setting, press the PART and buttons simultaneously.

■ SELECTING THE MT - 32 “SOUND MAP”

The SOUND Canvas can be set to the sound arrangement (Tone Map) of the Roland MT - 32 (Multi - Timbral Sound Module). If you want to hear song data that was created for the MT - 32, set the SOUND Canvas according to the instructions below.

● Initial settings

When you set the SOUND Canvas to the sound arrangement of the MT - 32, The SOUND Canvas settings will become identical to the power on settings of the MT - 32. The following illustration shows these settings.

< Part settings >

Part	MIDI Receive channel	Instrument (Instrument number)	Volume level	Pan	Reverb	Chorus	Key Shift
1	1	Acou Piano 1 (1)	100	0	64	0	0
2	2	Slap Bass 1 (69)	100	L10	64	0	0
3	3	Str Sect 1 (49)	100	L10	64	0	0
4	4	Brs Sect 1 (96)	100	L10	64	0	0
5	5	Sax 1 (79)	100	L10	64	0	0
6	6	Ice Rain (42)	100	L46	64	0	0
7	7	Elec Piano 1 (4)	100	R27	64	0	0
8	8	Bottle Blow (111)	100	L63	64	0	0
9	9	Orche Hit (123)	100	R63	64	0	0
10 (Drum)	10	CM-64/32L Set (128)	100	0	64	0	0

* Parts 11—16 are factory presets.

< Setting of all parts >

Volume level	Pan	Reverb	Chorus	Key Shift
127	0	64	64	0

● Differences of the MT - 32

If you set the SOUND Canvas to the sound arrangement of the MT - 32, you will be able to play data in the same manner as if you were using the MT - 32. However, since the MT - 32 is organized differently than the SOUND Canvas, you will not be able to perfectly duplicate the operations of the MT - 32. Please consider the following differences:

< Changing the sound >

When you change the sound of an instrument using velocity, modulation, aftertouch, etc., subtle changes in the sound will be heard.

< Exclusive messages >

The SOUND Canvas and the MT - 32 cannot exchange Exclusive messages. Therefore, if Exclusive messages of the MT - 32 are received by the SOUND Canvas, the settings of the latter will not be changed. For example, if the sound data of the MT - 32 (Exclusive message) is stored as song data, the same data cannot be perfectly reproduced when using the SOUND Canvas.

< Pan >

Pan movement is opposite from an actual MT - 32. To rectify this, reverse the L/R orientation of the Audio Output jacks.

< Maximum polyphony >

The MT - 32 has a greater maximum polyphony (MT - 32: 32 tones, SOUND Canvas: 28 tones), but the SOUND Canvas uses a lower number of voices to create instrument sounds. So in actuality, the SOUND Canvas makes better use of note messages.

Note: When you set the SOUND Canvas to the Tone Map of the MT - 32, all prior settings will be lost.

⇒The maximum polyphony will differ depending on the number of voices being used. For more details, refer to P.56.

⇒When you want to return to the SOUND Canvas's Tone Map, refer to "Returning to factory presets" on page 37.

● Setting the sound arrangement of the MT-32

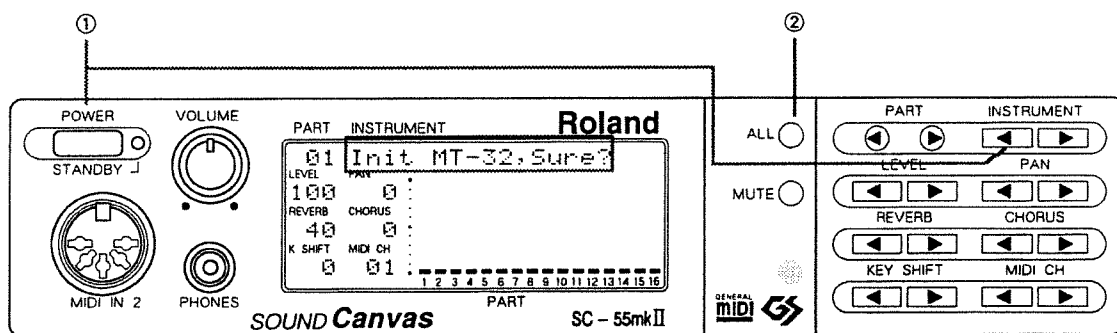

- ① While holding INSTRUMENT , turn the power on. "Init. MT-32, Sure?" will be shown in the display.
- ② Press **ALL** to execute. (Press **MUTE** to stop the operation.)

CHANGING A PATCH NAME

The SOUND Canvas has a Patch name for a collection of sound and effects (“ – SOUND Canvas – ” displayed when **ALL** is pressed). These can be changed.

If the changed name is stored in a sequencer (☞ P.60), the name will be displayed when the data is transferred to the SOUND Canvas again.

● Changing a Patch name

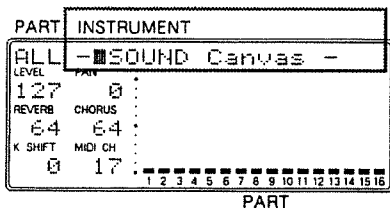
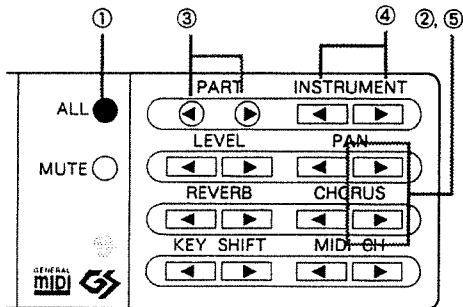

① Press **ALL** so the button indicator lights.

② Press **PAN** and **CHORUS** simultaneously.
The character (blank space) at the selected position will flash.

③ Select the position of the character using **PART**.

④ Specify each letter using **INSTRUMENT**.

The following letters are available:

Space AB...Z ab...z 012...9 & # ! ? . , : ; ' " * + - / < = >
() [] { } ^ _ | \$ % @ ¥ ` → ←

Pressing **ALL** will call the letters in such sequence as A → a → 0 → A.

Pressing **MUTE** will select space.

⑤ Complete the operation by pressing **PAN** and **CHORUS** simultaneously.

⇒ The setting will return to “ – SOUND Canvas – ” when a GM system ON or GS reset message (☞ P.75) is received.

STORING/RECALLING SOUND PARAMETERS

It is possible for the SOUND Canvas to store all the settings of the parameters of the sound source (instrument, volume level, pan, etc. in each part) in its internal memory for future recall.

How to store Sound Parameters

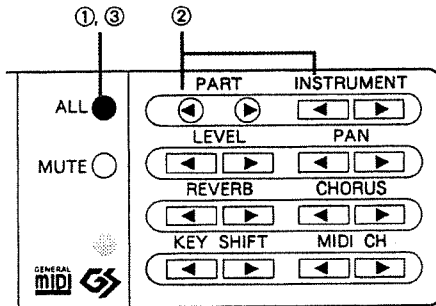

- ① Press **ALL** to turn the indicator on.
- ② Press **INSTRUMENT** while holding down **PART**. "Save All, Sure?" will be shown in the display.
- ③ The settings are stored when **ALL** is pressed. (To stop the procedure, press **MUTE**.)

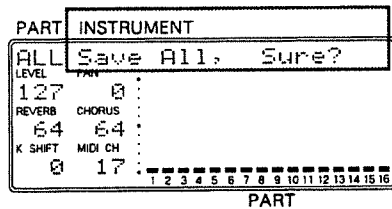

- * Any existing data will be overwritten when new settings are stored.
- * Any data you have saved will be retained even after the unit is switched off. If, however, you initialize all the data ("Int All" P.37), any saved data will be automatically erased and replaced with the initial data preprogrammed by the manufacturer (Factory Settings).

How to recall Sound Parameters

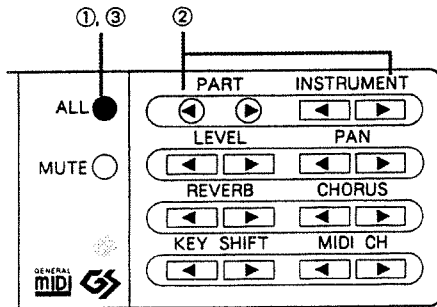

- ① Press **ALL** to turn the indicator on.
- ② Press **INSTRUMENT** while holding down **PART**. "Load All, Sure?" will be shown in the display.
- ③ The settings are recalled when **ALL** is pressed. (To stop the procedure, press **MUTE**.)

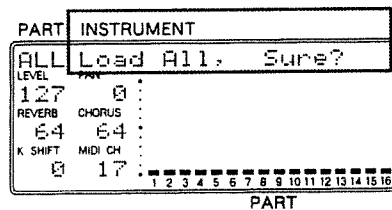

HOW TO SET THE BAR DISPLAY

< Bar display >

You can select which type of display will be used to indicate the volume level. There are eight display types to choose from:

Type 1 : Bar display (factory preset)

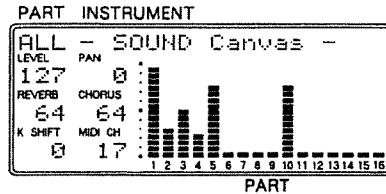

Type 2 : Single segment display

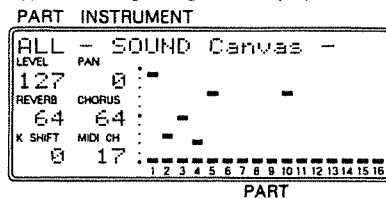

Type 3 : Top to bottom Bar display

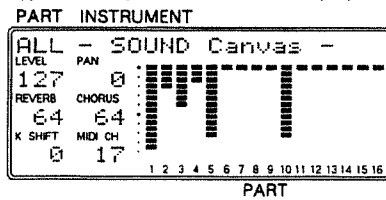

Type 4 : Top to bottom Single segment display

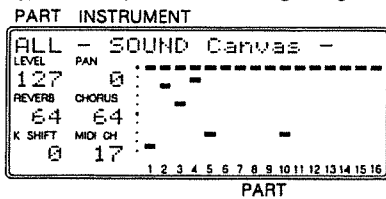

Type 5 : Reverse 1

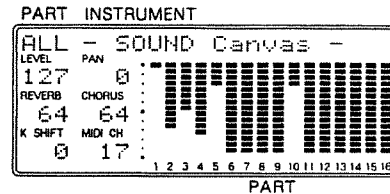

Type 6 : Reverse 2

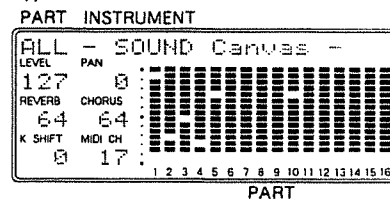

Type 7 : Reverse 3

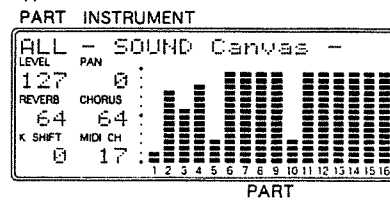

Type 8 : Reverse 4

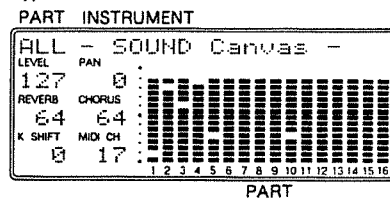

< Peak hold >

To allow confirmation of the peak level (maximum value) of the volume, the bar display will hold the peak level segment for several seconds. You can select one of the four following types of peak level display:

Off : Peak level hold is not in effect.

Type 1 : The peak level segment goes down after holding the peak level (normal)

Type 2 : The peak level segment goes off after holding the peak level

Type 3 : The peak level segment goes up after holding the peak level

* When Type 1 or Type 3 is selected for Bar Display types 3, 4, 7, and 8, the Peak Level segment will be reversed.

● Setting instructions

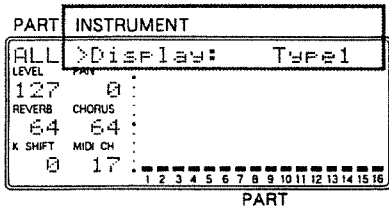
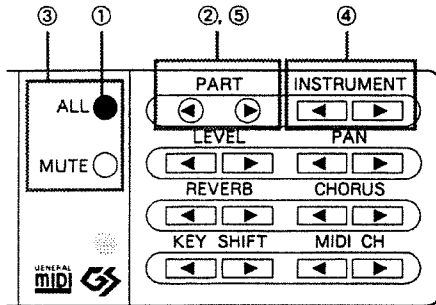

- ① Press **ALL** to turn the button indicator on.
- ② Press the PART buttons (**◀** and **▶**) simultaneously.
- ③ Use the **ALL** and **MUTE** buttons to select the display function you want to set.
 "Display" : Bar display type
 "Peak Hold" : Peak hold type
- ④ Use the INSTRUMENT **◀▶** buttons to set the display type.
- ⑤ After setting, press the PART buttons (**◀** and **▶**) simultaneously to finalize the selection.

■ ADJUSTING THE DISPLAY CONTRAST

The display may be difficult to read depending on where the SOUND Canvas is placed. In such a situation it is possible to adjust the contrast of the display.

● LCD Contrast : 1—16

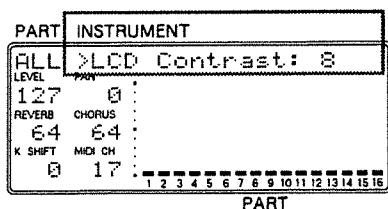
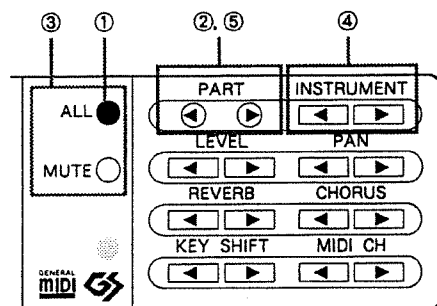

- ① Press **ALL** to turn the button indicator on.
- ② Press the **PART** buttons (◀ and ▶) simultaneously.
- ③ Use the **ALL** and **MUTE** buttons to select "LCD Contrast".
- ④ Use the **INSTRUMENT** ◀ ▶ buttons to adjust the contrast.
- ⑤ After adjusting, press the **PART** buttons (◀ and ▶) simultaneously to finalize the setting.

SELECTING INSTRUMENT VARIATIONS

Some main Instruments (called Capitals) contain Variations (similar sound, with slightly different timbres). The SOUND Canvas contains 128 Capitals and 226 Variations (☞ P.84).

Enter the variation mode to select Variations (following procedure). The sound effects (SFX: effective sounds) and MT - 32 instruments are selected in the variation mode. The mode for selecting Capitals is a factory default setting.

When selecting variations with a MIDI device, use Bank Select and Program Change messages.

● Selecting Variations

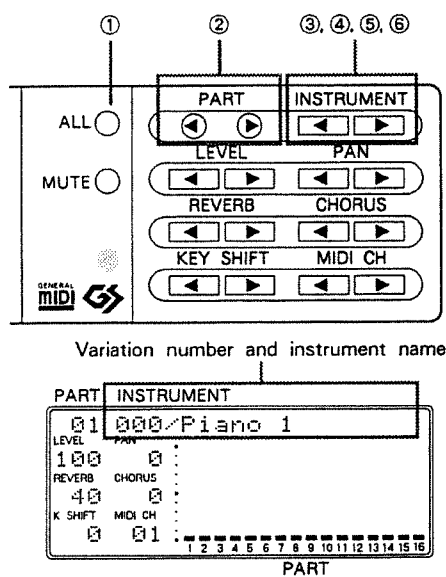

① Make sure that the **ALL** button indicator is off. If the indicator is on, press the button to turn it off.

② Use the **PART** buttons to select the part.

③ Press **INSTRUMENT** and simultaneously, and enter the variation mode.

As soon as the displayed Instrument number is changed to Variation number, a “/” mark will be displayed in front of the instrument name and the Variation can then be changed.

④ Select the Variation with **INSTRUMENT** .

⑤ The variation mode will change to the capital mode when **INSTRUMENT** are pressed simultaneously again.

⇒When you want to return to the status in which Instrument numbers can be changed, a mark will be displayed in front of the instrument name indicating what type of instrument has been selected.

Blank : Capital (Variation number 0)

+ : Variation number 1—126

: Variation number 127 (MT - 32 instrument)

Instrument No.	Variation No.	Display during capital mode	Display during variation mode
003	000	003 Piano 3	000/Piano 3
003	008	003+Piano 3w	008/Piano 3w
003	127	003#Acou Piano 3	127/Acou Piano 3

⇒Some variation numbers will not be in sequential order (☞ P.84).

* If the part is set to the Drum Part (☞ P.25), the variation mode will not be displayed.

● Selecting Variations with another MIDI device or Computer

Capital tones and Variation tones can be selected with remote control by sending MIDI messages from a MIDI keyboard or sequencer. When the instrument button is used on the MIDI keyboard, the MIDI message will be transmitted automatically (☞ P.23).

When selecting a Capital, only the Program Change message needs to be sent. However, to select a Variation, a Bank Select message must also be sent. Therefore, Variations cannot be selected with MIDI keyboards that cannot transmit Bank Select messages. The Bank Select message is a Control Change message (☞ P.72).

Capital tones and variations can be selected.

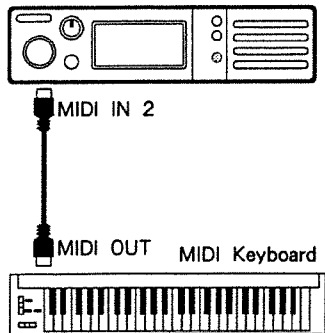

Bank select and Program Change messages are transmitted.

Send the messages in the following order when creating the MIDI messages with a sequencer or a personal computer.

- ① Control Change 0/value (Variation number)
- ② Control Change 32/value (0)
- ③ Program Change number (Instrument number)

Number ① and ② are the Bank Select message.

For example, to select Variation number 8 and instrument number 3 (Piano3w), the following data must be sent to the SOUND Canvas.

<Displayed in decimal form>

- ① Control change 0 Value 8 (Variation number)
- ② Control change 32 Value 0
- ③ Program change 2 (Instrument number 3)

<Displayed in hexadecimal form>

- ① BnH 00H 08H
- ② BnH 20H 00H
- ③ CnH 02H

“H” indicates a hexadecimal expression; decimal 32 will be expressed as “20H” in hexadecimal form (☞ P.103). “n” represents the MIDI channel.

For example, to change the instrument assigned to MIDI channel 4, “n” must be set to “3” (one number less than the channel number). The instrument number must also be one less than its normal value (Ex, to change Instrument number 3, enter the number 2).

The Variation number can be used as it is.

* In Drum Parts (☞ P.25), Bank Select messages will be ignored.

* The instrument selected via MIDI message will not be displayed if “USER” is turned on.(☞ P. 28).

● Turning the Instrument Change Reception Switch ON and OFF

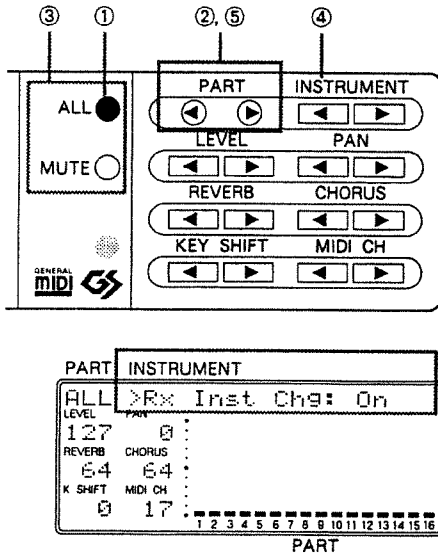

- ① Press **ALL** to turn the button indicator on.
- ② Press the PART buttons (◀ and ▶) simultaneously.
- ③ Use the **ALL** and **MUTE** buttons to select "Rx Inst Chg" (Instrument change reception switch).
- ④ Use the INSTRUMENT ◀ button to select "Off".
Press INSTRUMENT ▶ to reselect "On".
- ⑤ After setting, press the PART buttons (◀ and ▶) simultaneously to finalize.

*When the Instrument reception switch is turned off, Program Change messages will be ignored in all parts. Therefore, the Instrument/Drum set cannot be changed with those MIDI messages when turned off.

CHANGING THE WAY THE SOUND IS OUTPUT

Bend Range, Modulation Depth, Key Range, Velocity Sens Depth, Velocity Sens Offset, M/P mode, Portamento, Portamento time, Modulation and Expression functions can be set to suit your taste.

● Bend Range : -24—+24 (semitone steps ; ±2 octaves)

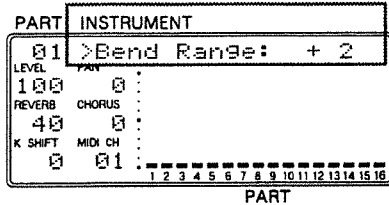

Bend Range determines the range over which the pitch can change by moving the pitch bend lever or wheel (pitch bend message) on a MIDI keyboard.

● Modulation Depth : 0—127

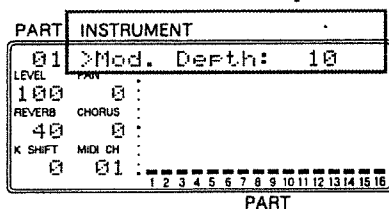

The Modulation Depth value determines the depth of the modulation (vibrato effect etc.) which is applied by moving the modulation lever or wheel.

● Key Range : C-1—G-9

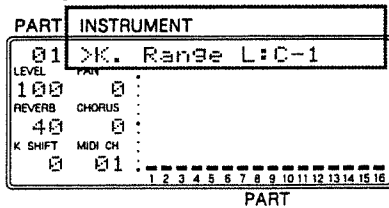

Key Range is a parameter that determines the range over which a particular sound will be heard. This range is determined by the settings of Key Range L (the lowest note) and Key Range H (the highest note). The value is displayed using the note name. Middle C is C4 (C6). You can set this function within the range of C1—G9 (0—127).

Set Key Range when you are using a MIDI keyboard to play the SOUND Canvas.

Correspondence between Note Numbers and Names

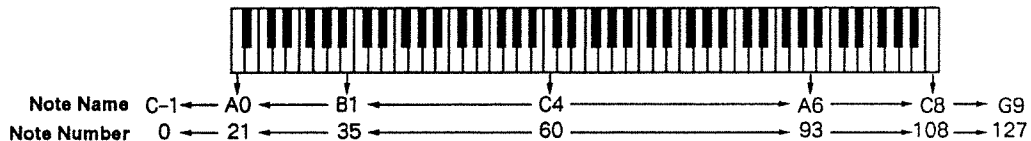

For example: Set parts 1 and 2 to the same MIDI receive channel. Then set the Key Range of part 1 to C-1—B3, and the Key Range of part 2 to C4—G9. Then, by assigning a different instrument to parts 1 and 2, you can play two different instruments on one MIDI keyboard with C-4 as the dividing point.

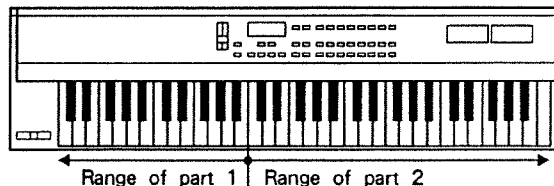
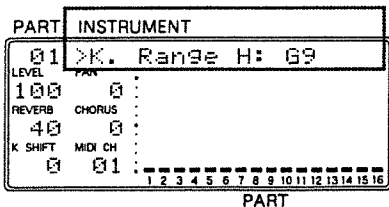

- Velocity Sens Depth : 0—127
- Velocity Sens Offset : 0—127

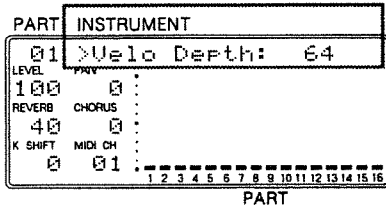

You can set the relationship between playing strength (velocity) and the volume level actually produced.

When the Velocity Sens Depth parameter is set to a high value (above 64), the output volume will vary considerably, even though the variation in your playing strength (velocity) is minimal. Conversely, when the Velocity Sens Depth is set to a low value (below 64), the output volume changes very little, despite wide variation in playing strength (velocity) (☞ figures 1 and 2 below).

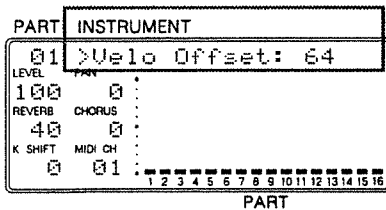

The Velocity Sens Offset parameter also specifies how the output volume varies with playing strength (velocity), but in a slightly different manner.

At a value of 64 for both the Depth and Offset parameters (the default setting) there is a direct relationship between playing strength (velocity) and the output volume. For example, at minimum velocity, minimum volume is obtained, and at maximum velocity, maximum output volume will be produced (☞ figure 1).

Values greater than 64 specify the minimum output level that can be produced by minimum velocity (☞ figure 5). Values less than 64 specify the minimum velocity at which the Instrument begins to sound (☞ figure 4).

*Sounds may not be output depending on the settings. If this occurs, set the Velocity Sens Depth or Velocity Sens Offset to higher values.

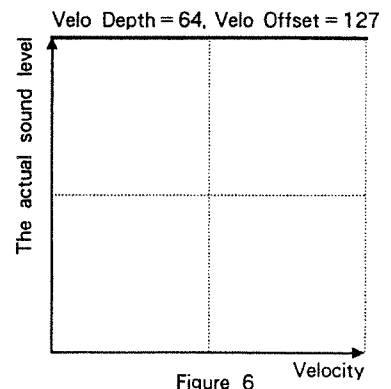
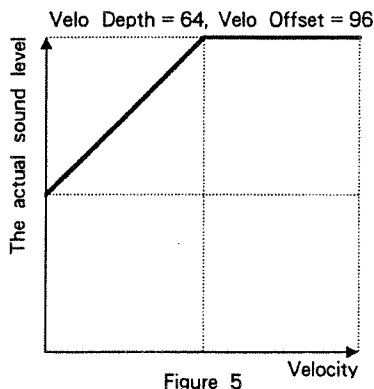
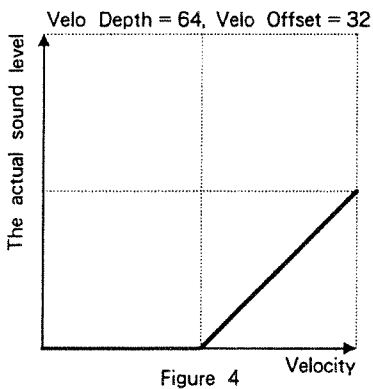
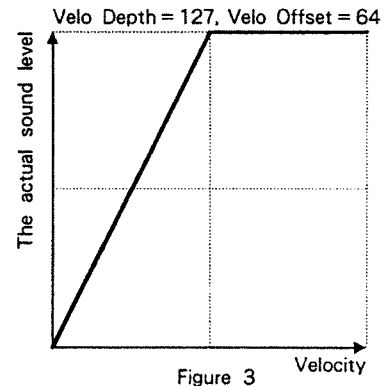
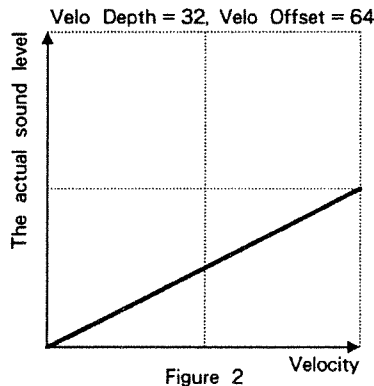
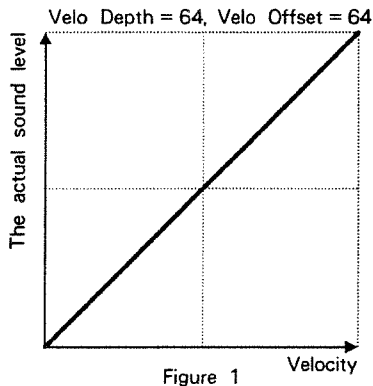

● **M/P mode** : Poly, Mono

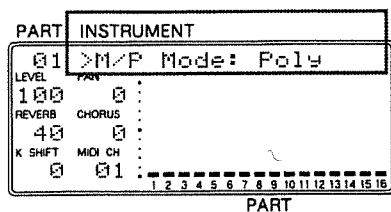

Select the mode of sound output.

Poly : Many notes can be played or heard at once. This is the usual setting.
Mono : Only one note can be played or heard at a time. Use this setting for solo instruments such as brass, trumpet, etc. This is also effective when playing solo with a Synth Lead instrument, etc.

* Modifying the setting of M/P mode will not affect the sound that is set to the Drum Part.

● **Portamento** : On/Off

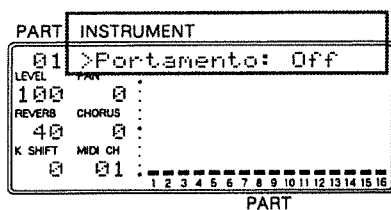

When Portamento is set to ON, the pitch between successively played notes changes in a smooth and continuous fashion.

● **Porta. Tm. (Portamento Time)** : 0—127

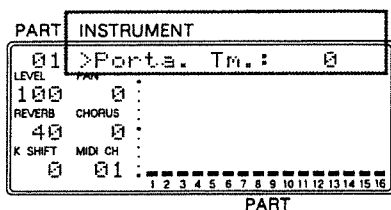

This parameter determines the time over which the pitch changes when Portamento is set to ON.

* The Portamento Time is set to 0 at the factory and it also becomes 0 when a GM system ON/GS reset message is received and portamento will not be applied. Set the Portamento Time when applying portamento.

● **Modulation** : 0—127

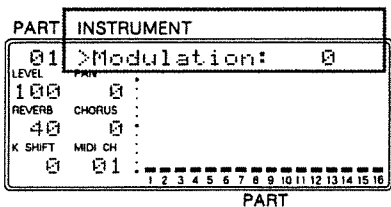

This parameter determines the degree of modulation applied according to the modulation depth setting.

● Expression : 0—127

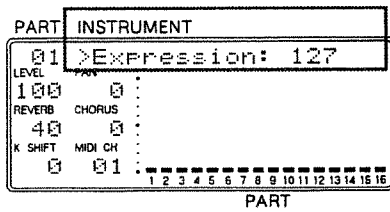

This parameter determines the degree of the expression function for each part. Changes in expression are the same as volume level changes (☞ P.19, 26); however, no sound is output when the expression is set to 0, even if the volume level is set to 127. The expression is set to 127 at the factory and it also becomes 127 when a GM system ON/GS reset message is received.

□ Setting instructions

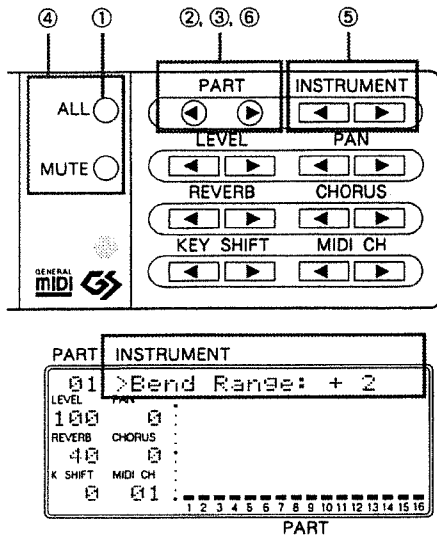

- ① Make sure that the **ALL** button indicator is off. If the indicator is on, press the button to turn it off.
- ② Press the PART buttons (◀ and ▶) simultaneously.
- ③ Use the PART ◀▶ buttons to select the part.
- ④ Use the **ALL** and **MUTE** buttons to select the function that you want to set.
 - Bend Range
 - Modulation Depth
 - Key Range L
 - Key Range H
 - Velocity Depth
 - Velocity Offset
 - M/P Mode
 - Portamento
 - Portamento Time
 - Modulation
 - Expression
- ⑤ Use the INSTRUMENT ◀▶ buttons to set the values.
- ⑥ After setting, press the PART buttons (◀ and ▶) simultaneously to finalize the settings.

CHANGING THE SOUND PARAMETERS

The sound parameters of an instrument can be changed to suit your taste.

Before changing the sound parameters

The SOUND Canvas contains parameters (elements) that are used to alter the sound. Even if the value of a parameter is the same, the effect may be different depending on the instrument that is selected.

Sound parameters are also set for each part. Therefore, if you change to another instrument after changing the value of a parameter, that instrument's sound will be changed.

The function of each parameter

● Vibrato

Vibrato adds a pitch - fluctuation effect to the sound.

Vibrato Rate : - 50 — + 50

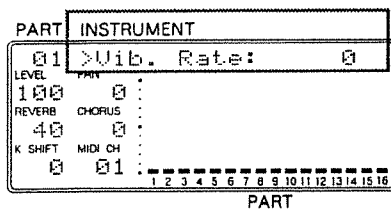

This parameter determines the speed with which the pitch will fluctuate.

- + Values : Pitch fluctuations will be faster
- Values : Pitch fluctuations will be slower

Vibrato Depth : - 50 — + 50

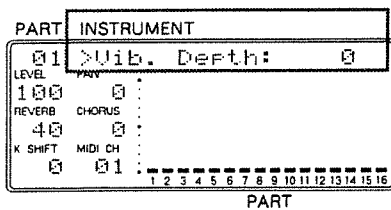

This parameter determines the depth of the pitch fluctuations.

- + Values : Pitch fluctuations will be deeper
- Values : Pitch fluctuations will be shallower

Vibrato Delay : - 50 — + 50

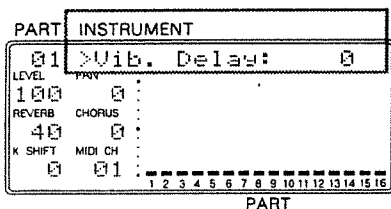

This parameter adjusts the time delay after which the vibrato will begin.

- + Values : the time delay will be longer
- Values : the time delay will be shorter

● Nuances of the sound

Cutoff Freq. (Cutoff Frequency) : - 50 — + 50

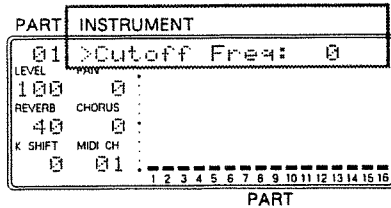

This parameter determines the frequency at which the overtone elements of a sound are cut. The change may be completely different depending on the instrument that is selected.

Generally speaking, negative (-) values usually result in a softer sound.

⇒ Most instrument sounds are created without a large cut in the overtone structure. Raising the Cutoff Frequency of these instruments will not change the sound greatly.

Resonance : - 50 — + 50

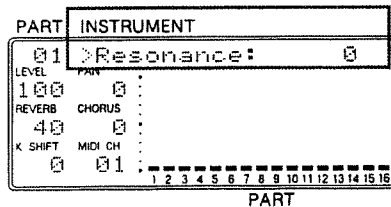

This parameter determines how much the overtone elements which are cut by the Cutoff Freq. will be emphasized.

Generally speaking, higher values will result in a more characteristic synth - type sound.

● Envelope

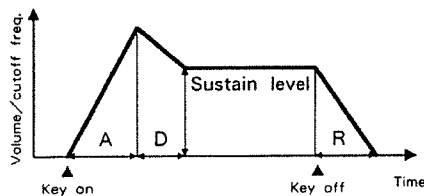

These settings create changes in volume and Cutoff Frequency over time. The envelope parameter is adjusted to make the start of a sound sharper (attack time) or to create a gradual decay of the sound when the key is released (release time).

A : Attack time

D : Decay time

R : Release time

Attack time : - 50 — + 50

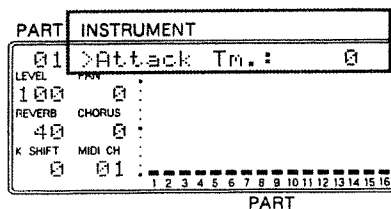

This setting determines the point at which the sound begins.

Decay time : - 50 — + 50

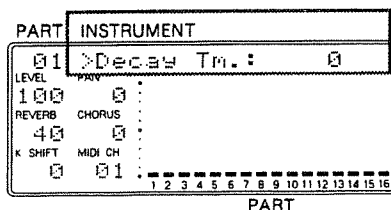

This setting determines the point at which the sustain level is reached.

* Use Release time to adjust the volume decrease on instruments that have a natural decay (such as piano and guitar).

● Release time : - 50 — + 50

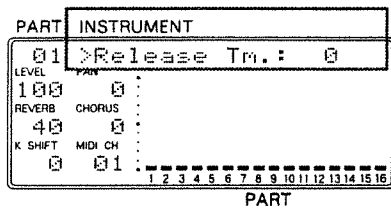

This setting determines the point at which the sound is released.

□ Setting instructions

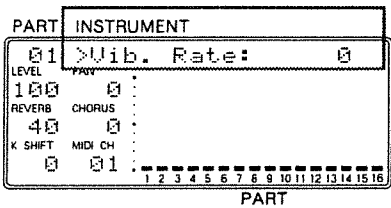
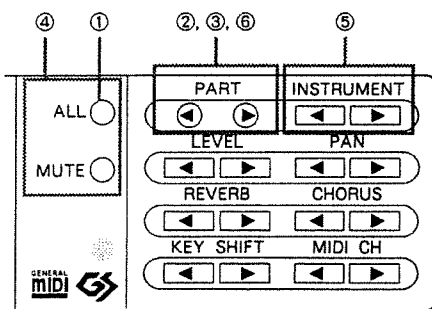

- ① Make sure that the **ALL** button indicator is off. If the indicator is on, press the button to turn it off.
- ② Press the PART buttons (◀ and ▶) simultaneously.
- ③ Use PART ◀▶ to select the part for setting.
- ④ Use the **ALL** and **MUTE** buttons to select the sound parameter:
 Vib. Rate
 Vib. Depth
 Vib. Delay
 Cutoff Freq.
 Resonance
 Attack Time
 Decay Time
 Release Time
- ⑤ Use the INSTRUMENT ◀▶ buttons to set the value.
- ⑥ After setting, press the PART buttons (◀ and ▶) simultaneously to finalize the settings.

■ CHANGING THE TYPE OF REVERB AND CHORUS

You can select one of eight types of both Reverb and Chorus effects. Make these selections according to your preference. The type cannot be changed per part. Perform the operation on page 27 to level adjust the effect level on each part.

< Reverb type >

Type	Effect
Room 1—3	Reverb that simulates the natural echo of a room. Sharply-defined reverb with a broad spread.
Hall 1—2	Reverb that simulates the natural echo of a hall. Smooth reverb, with greater depth than Room.
Plate	This effect simulates Plate Echo (a type of reverb that uses the vibration of metal plates to produce a metallic echo).
Delay	Standard delay effect.
Panning Delay	Delay repetitions pan to left and right. It is effective when the Sound Canvas is connected to a stereo system.

< Chorus type >

Type	Effect
Chorus 1—4	Standard chorus effect.
Feedback Chorus	Chorus effect that simulates a flanger with soft sound.
Flanger	An effect that is sometimes used to simulate the takeoff and landing of a jet.
Short Delay	A delay repeated in a short time.
Short Delay (FB)	A short delay repeated many times.

● How to change the Reverb and Chorus type

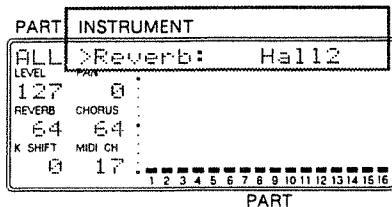
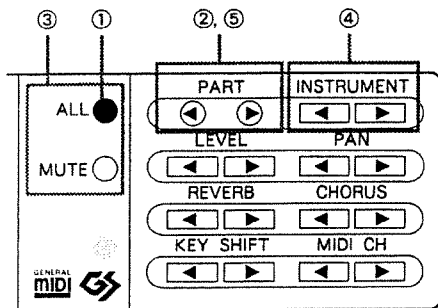

- ① Press **ALL** to turn the button indicator on.
- ② Press the **PART** buttons (**◀** and **▶**) simultaneously.
- ③ Use the **ALL** and **MUTE** buttons to select the function that you want to set:
 Reverb
 Chorus
- ④ Use the **INSTRUMENT** **◀▶** buttons to select the type.
- ⑤ After setting, press the **PART** buttons (**◀** and **▶**) simultaneously.

■ HOW TO USE VOICE RESERVE

The SOUND Canvas has a limited number of notes that can be played simultaneously. When using a sequencer for ensemble performance, if too many voices are required at once, some sounds may be cut off, or play may not be possible. The following section explains how to resolve this problem.

● About the maximum polyphony

The SOUND Canvas can play up to 28 voices simultaneously. The number of notes (P.84) that will actually be heard depends upon the instrument that is selected.

Some instruments are created by combining two voices (parts of a sound) to produce a more realistic sound. When you want to hear or play an instrument such as this, you must use two voices. Therefore, the maximum polyphony will be 14.

● When exceeding the maximum polyphony

When creating song data, the song data should be written with the maximum polyphony of the SOUND Canvas in mind. If the song data should happen to temporarily exceed the limit, it is possible that some important notes will be cut, making the song sound unnatural. The SOUND Canvas provides a Note Sounding Priority and Voice Reserve function to minimize such occurrences.

Note Sounding Priority order of part

Note Sounding Priority order	Part number
1	10 (Drum part)
2	1
3	2
4	3
5	4
6	5
7	6
8	7
9	8
10	9
11	11
12	12
13	13
14	14
15	15
16	16

When the number of notes exceeds 28 voices, those that have been sounding the longest will be turned off in order. The Note Sounding Priority order determines the priority with which to turn off the notes. In short, the part having the lowest priority will be turned off first, the next to lowest will be turned off second, and so on.

The part's Note Sounding Priority order is shown in the chart to the left. When you make a song, consider the priority order carefully when you specify each SOUND Canvas part.

< Voice Reserve >

The part's Note Sounding Priority only determines the priority order. It does not secure the number of notes that will be heard. Therefore, it is possible that a part will be cut off even if it has a high priority. Voice Reserve is an effective function for resolving this problem.

Voice Reserve is a function that reserves a minimum number of voices for each part, in case the total number of voices exceeds 28. For example, if you set the Voice Reserve number of a particular part to 10, ten voices will be reserved for that part regardless of the Note Sounding Priority order. If the instrument consists of one voice, ten notes will be secured for that instrument. Furthermore, the SOUND Canvas can play up to 28 voices simultaneously, so the total number of voices that can be secured is 28.

● Voice Reserve number : 0—28

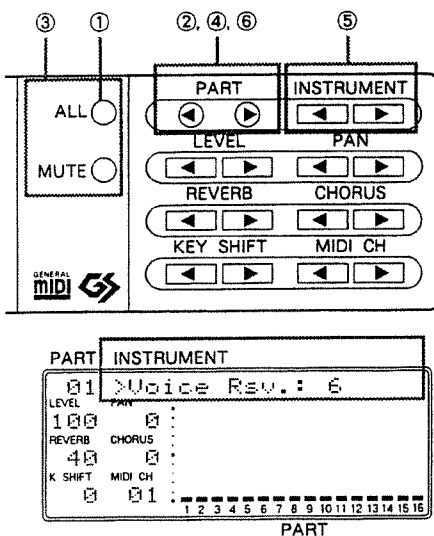

- ① Make sure that the **ALL** button indicator is off. If the indicator is on, press the button to turn it off.
- ② Press the **PART** buttons (◀ and ▶) simultaneously.
- ③ Use the **ALL** and **MUTE** buttons to select "Voice Rsv".
- ④ Use the **PART** (◀ ▶) buttons to select the part.
- ⑤ Use the **INSTRUMENT** (◀ ▶) buttons to set the Voice Reserve number.
- ⑥ After setting, press the **PART** buttons (◀ and ▶) simultaneously to finalize the setting.

* The total of Voice Reserve number that you can set for all parts is 28. If the Voice Reserve number doesn't get any higher at the time of setting, make the Voice Reserve number of the other parts lower.

STORING THE BASIC SETTINGS IN A SEQUENCER

The data transmitted from the SOUND Canvas's MIDI OUT can be stored in a sequencer.

Connections

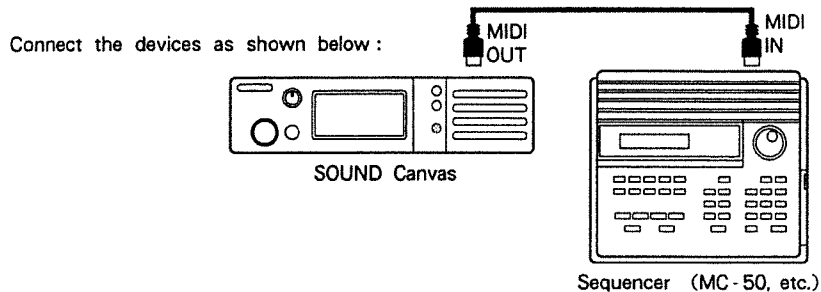

SETUP SEND

Setup Data can edit the basic parameters. If you have set the Setup Data at the beginning of a song data, you can play the SOUND Canvas in the desired settings.

The setup send mode allows you to transmit the Setup Data for the GM and GS. Setup Data includes the following parameters.

Parameter name	GM setup send mode		GS setup send mode		refer to page
	All	Part	All	Part	
GM system on	○	○	×	×	☞ P.75
GS reset	×	×	○	○	
Instrument (variation)	×	○	×	○	☞ P.46
Volume level	○	○	○	○	☞ P.19, 26, 80
Pan	×	○	○	○	☞ P.19, 26
Reverb	×	○	○	○	☞ P.20, 26
Chorus	×	○	○	○	☞ P.20, 26
Part mode	×	×	×	○	☞ P.25

All : Transmitting the parameter settings common to all Parts. ○ : Transmitted
 Part: Transmitting the parameter settings that varies depending on the Parts. × : Not transmitted

It is possible to record the Setup Data in a specific Part. (☞ P.59 "Transmitting 2")

- * The volume level for the entire Parts in the GM Setup Send is always transmitted as Master Volume messages of the Universal Realtime Exclusive.
- * The SC - 55 or SC - 155 does not receive Master Volume message of the Universal Realtime Exclusive. The SC - 55mk II receives that message.
- * The volume level for the entire Parts is transmitted as Exclusive messages (GS Format) (as preprogrammed at the factory). However, the same data will be transmitted as Master Volume messages of the Universal Realtime Exclusive if the "Universal Realtime Exclusive Switch" (☞ P.80) is set to ON.
- * To receive GS Setup Data, it is required to set the MIDI channel (☞ P.63) and the Device ID Number (☞ P.76) to the same number as the Setup Data.

● How to transmit 1 (transmission of all parts and specified part settings)

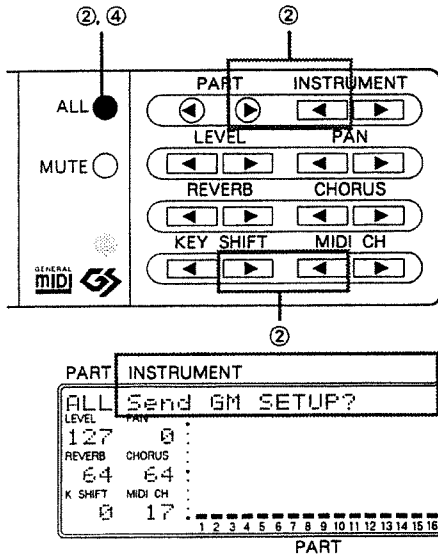

The setting details common to all parts, and settings for specified parts can be transmitted simultaneously.

- ① After turning the **[ALL]** button indicator off, mute the part that you do not want to transmit (☞ P.30).
- ② After turning the **[ALL]** button indicator on,
 - ◀ Sending GM Setup ▶
Press the KEY SHIFT **[▶]** and MIDI CH **[◀]** buttons simultaneously. "Send GM SETUP?" will be shown in the display.
 - ◀ Sending GS Setup ▶
Press the PART **[▶]** and INSTRUMENT **[◀]** buttons simultaneously. "Send GS SETUP?" will be shown in the display.
- ③ Start sequencer recording (Realtime recording).
- ④ Press **[ALL]** to transmit. (To stop the procedure, press **[MUTE]**.)
- ⑤ Stop sequencer recording.

* The settings common to all parts is transmitted as Exclusive messages.

* Capacity of transmission data: Setting data common to all parts : 100 bytes.
Setting data for specified parts : 100 bytes in the first part, then increases by 50 bytes for each Part.

● How to transmit 2 (transmission of the settings of a specified part)

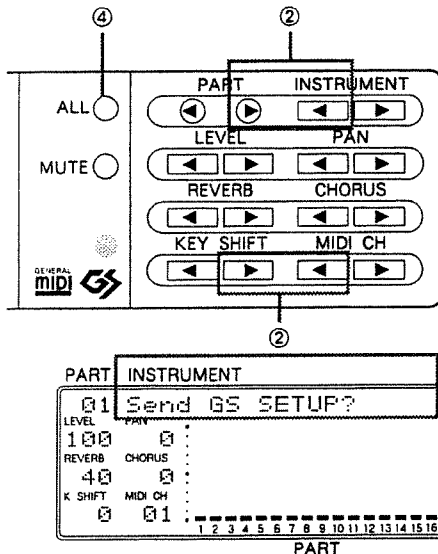

Only the setting details for the specified part is transmitted.

- ① After turning the **[ALL]** button indicator off, mute the part that you do not want to transmit (☞ P.30).
- ② Holding the **[ALL]** button indicator off,
 - ◀ Sending GM Setup ▶
Press the KEY SHIFT **[▶]** and MIDI CH **[◀]** buttons simultaneously. "Send GM SETUP?" will be shown in the display.
 - ◀ Sending GS Setup ▶
Press the PART **[▶]** and INSTRUMENT **[◀]** buttons simultaneously. "Send GS SETUP?" will be shown in the display.
- ③ Start sequencer recording (Realtime recording).
- ④ Press **[ALL]** to transmit. (To stop the procedure, press **[MUTE]**.)
- ⑤ Stop sequencer recording.

* Capacity of transmission data: Setting data for specified parts : 100 bytes in the first part, then increases by 50 bytes for each Part.

STORING ALL THE SETTINGS IN A SEQUENCER

The SOUND Canvas can transmit all sound module settings as MIDI messages (Exclusive messages). The following parameter settings are included in the transmission data. This can be used to save the SOUND Canvas settings in a sequencer or personal computer.

If these MIDI messages are inserted at the beginning of song data, the same settings can be played at anytime:

Overall part settings	Part settings	
Volume level of all parts	Instrument selection	Part Mode
Pan of all parts	Drum set selection	Bend range
Reverb level of all parts	Reverb	Voice reserve
Chorus level of all parts	Chorus	Key range low
Key shift of all parts	Pan	Key range high
Master tune	Volume level	Velocity sens depth
Reverb type	Key shift	Velocity sens offset
Chorus type	MIDI channel	M/P mode
		Vibrato rate
		Vibrato depth
		Vibrato delay
		Cutoff frequency
		Resonance
		Attack time
		Decay time
		Release time

Groups of Exclusive messages are called bulk dump data. Bulk dumping refers to transmitting the data (parameter settings) stored in the SOUND Canvas from MIDI OUT. To set two SOUND Canvas units to the same parameter settings, connect a MIDI cable, and transmit the data via a bulk dump.

* The amount of data in a bulk dump can be quite large, so confirm the memory capacity of the MIDI device (sequencer, etc.) that is to receive the data before sending it. If there is not enough memory space, the receiving will be interrupted, and not all the data will be received. The amount of data transmitted from the SOUND Canvas is noted on the following page.

* Bulk dump data cannot be received if the Exclusive receive switch (☐ P.79) is turned off.

● How to transmit 1 (transmission of all SOUND Canvas settings)

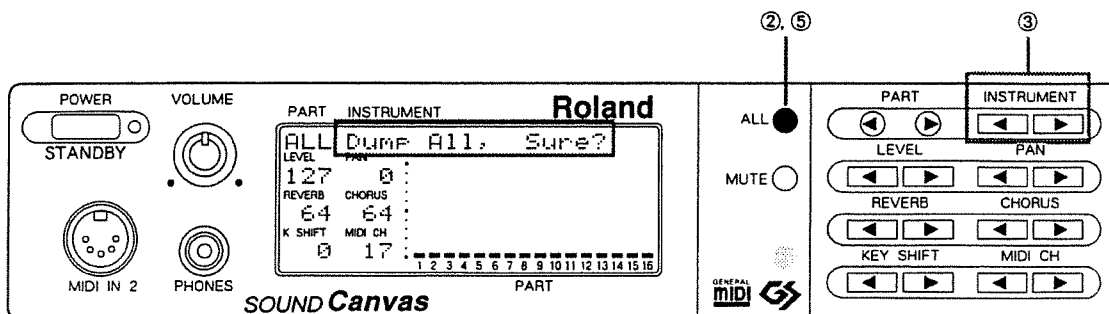

① Using a MIDI cable, connect the MIDI OUT of the SOUND Canvas to the MIDI IN of the sequencer.

- ② Press **ALL** to turn the button indicator on.
- ③ Press the INSTRUMENT buttons (◀ and ▶) simultaneously.
"DUMP All, Sure?" will be shown in the display, and the SOUND Canvas will be ready to transmit.
- ④ Start sequencer recording (Realtime recording).
- ⑤ Press **ALL** to transmit. (To stop the procedure, press **MUTE**.)
- ⑥ Stop sequencer recording.

* Capacity of transmission data

All setting data of SOUND Canvas : 8 Kbytes

● How to transmit 2 (transmission of all parts and specified part settings)

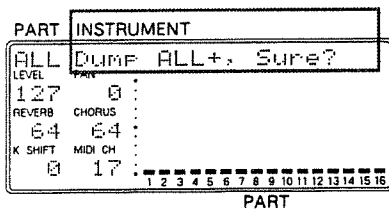
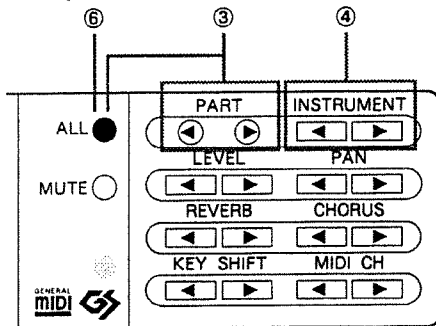

- ① Using a MIDI cable, connect the MIDI OUT of the SOUND Canvas to the MIDI IN of the sequencer.
- ② After turning the **ALL** button indicator off, mute the part that you do not want to transmit (☐ P.30).
- ③ After turning the **ALL** button indicator on, press the PART buttons (◀ and ▶) simultaneously.
- ④ Press the INSTRUMENT buttons (◀ and ▶) simultaneously.
"DUMP ALL+, Sure?" will be shown in the display, and the SOUND Canvas will be ready to transmit.
- ⑤ Start sequencer recording (Realtime recording).
- ⑥ Press **ALL** to transmit. (To stop the procedure, press **MUTE**.)
- ⑦ Stop sequencer recording.

* Capacity of transmission data

Setting data common to all parts : 200 bytes

Setting data for specified part : 250 bytes (Normal Part)

2 Kbytes (Drum Part)

● How to transmit 3 (transmission of the settings of a specified part)

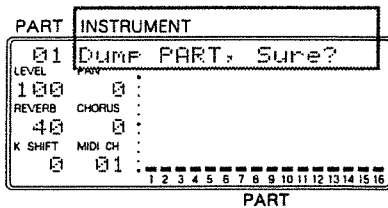
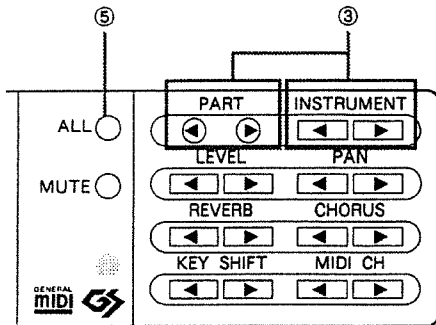

- ① Using a MIDI cable, connect the MIDI OUT of the SOUND Canvas to the MIDI IN of the sequencer.
- ② After turning the **ALL** button indicator off, mute the part that you do not want to transmit (☞ P.30).
- ③ After pressing the PART buttons (◀ and ▶) simultaneously, press the INSTRUMENT buttons (◀ and ▶) simultaneously.
"DUMP PART, Sure?" will be shown in the display, and the SOUND Canvas will be ready to transmit.
- ④ Start sequencer recording (Realtime recording).
- ⑤ Press **ALL** to transmit. (To stop the procedure, press **MUTE**.)
- ⑥ Stop sequencer recording.

* Capacity of transmission data

Setting data for specified part : 250 bytes (Normal Part)

2 Kbytes (Drum Part)

■ CHANGING THE MIDI RECEPTION CHANNEL (PART)

Use the following procedure to change the MIDI reception channel of each part.

Refer to page 22, 69 for the relationship between MIDI channels and parts.

● Changing the MIDI reception channel (Part) : 1—16, Off

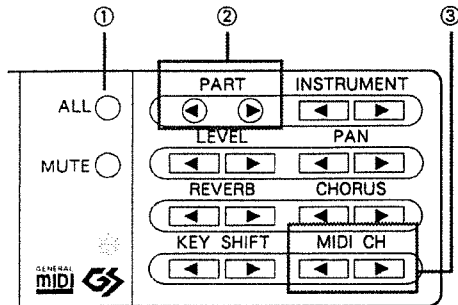

① Press **ALL** to turn the button indicator off.

② Use the **PART** buttons to select the part.

The MIDI reception channel of the selected part will be shown in the display.

③ Use the **MIDI CH** buttons to change the MIDI reception channel.

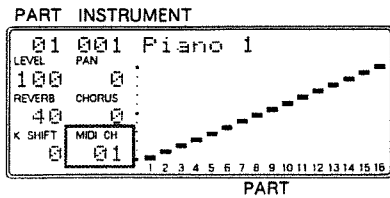

⇒ If you press **MIDI CH** and simultaneously, the MIDI reception channel setting of each part will be shown on the Bar Display. Press **MIDI CH** and again to return to the previous display.

* Note that the device ID number will change if the **MIDI CH** buttons are pressed when **ALL** is lit. (☞ P.76)

Appendix

■ TROUBLESHOOTING

If the SOUND Canvas does not perform as expected, please check the following points. If you can not solve the problem, discontinue use immediately and contact your Roland dealer or the nearest Roland service station as soon as possible.

⇒ If an error message appears in the display during operation, refer to the error message table on the following page.

⇒ If you are using the song data designed for playback with GM/GS - compatible devices, be sure the GM system ON/ GS Reset switch (P.79) is set to ON. If problems occur during playback, check the following points:

- **Cannot turn the power on**
 - Be sure to use only the included AC adaptor.
- **No sound**
 - Is the power to the connected devices turned on?
 - Is the volume control knob turned all the way down?
 - Can you hear the sound in the headphones? If you can, the problem is probably in an audio cable connection, or an amp or mixer.
 - Are all the segments at the bottom of the bar display off? If all parts are off, the mute function is ON. Turn mute off. (☞ P.30)
 - Is the volume level of all parts too low? (☞ P.19)
 - Is an external device using an expression pedal which is turned down?
- **A specified part cannot be heard**
 - Are the segments at the bottom of the bar display off? The mute function is ON for the parts that are not lit. Turn mute off. (☞ P.30)
 - Is the volume level of the part too low? (☞ P.26)
 - Does the part's MIDI receive channel match the MIDI transmit channel of the external device?
- **Notes within a specified range cannot be heard**
 - Has the Key Range been set? (☞ P.48)
- **Distorted sound**
 - When the sound of a specified instrument distorts, decrease the volume level of that part. (☞ P.26)
 - When the overall sound distorts, decrease the volume level of all parts (☞ P.19), or turn the volume control knob on the front panel down.
- **The pitch is wrong**
 - Is the Master Tune setting correct? (☞ P.33)
 - Does the pitch of all parts differ by more than one semitone? (☞ P.21)
 - Is the pitch of the specified part off by more than one semitone? (☞ P.27)
 - Has a pitch bend message been received, leaving the pitch "hanging" at some non - zero value? Return the bender to the center position or transmit the center value (40 00H) of the pitch bend message.
- **An Instrument cannot be changed**
 - Is the instrument receiving switch turned off? (☞ P.47)
 - Check that USER is not set to ON. (☞ P.28)
- **The Instruments sound strange**
 - Have you changed to another instrument after editing the sound? Set all sound parameter values to 0. (☞ P.51, 54)
- **Notes of an important part are cut off**
 - Change the voice reserve settings. (☞ P.56)
- **Exclusive messages cannot be received**
 - Is the Exclusive message receiving switch turned off? (☞ P.79)
 - Does the Device ID number of the Exclusive message that you are sending match the Device ID number of the SOUND Canvas? (☞ P.76)

■ ERROR MESSAGES AND OTHER MESSAGES

If you attempt to execute an incorrect operation or if some unexpected condition occurs, one of the following error messages will appear in the display (in the area that normally displays the instrument name and number).

Refer to this list, and take the appropriate action.

Battery Low	Reason : The internal memory backup battery is low. Action : Consult the nearest Roland service station.
Address Error	Reason : The address of the Exclusive message that is being received is incorrect.
DT1 Data Error	Reason : DT I (Data set 1) data that is being received is incorrect.
RQ1 Size Error	Reason : The size of RQ 1 (Request data 1) data that is being received is incorrect.
Check Sum Error	Reason : The Check Sum of the exclusive message that is being received is incorrect. Action : Check the data that is being transmitted and try the operation again. Also, make sure the MIDI cable isn't unplugged, broken, or shorted.
MIDI Buff. Full	Reason : A large amount of MIDI data was received in a short time and could not be processed. Action : Check that the transmitting device is not transmitting excessive amounts of MIDI data.
MIDI Off Line	Reason 1 : The MIDI device connected to MIDI IN has been turned off. Action 1 : This is not a malfunction. Reason 2 : It is possible that the MIDI cable connected to MIDI IN has been pulled out, or damaged? Action 2 : Check the MIDI cable connections.
NO INSTRUMENT -----	Reason : A Variation (Instrument) not found in the SOUND Canvas was requested. Action : The sound will not be heard (as the Instrument does not exist). Select another Instrument. (☞ P.84)
NO DRUM SET	Reason : A Drum set not found in the SOUND Canvas was specified. Action : The name of the Drum set used last will be selected instead.

■ ABOUT MIDI

MIDI stands for Musical Instrument Digital Interface. When a MIDI device is played, instrument performance data, etc., can be transmitted. MIDI is a world - wide standard, and the performance data of one device can be transmitted to another device, even if they are different models by different manufacturers. With the MIDI standard, performance information such as “play the keyboard” or “press down the pedal” is converted into MIDI messages and transmitted.

Knowledge about MIDI is not really necessary when playing commercial music data or playing with computer software (games, etc.). The SOUND Canvas can be played easily by following the operations given in the music data player (MIDI player) or software manuals.

[1] How MIDI messages are transmitted and received

Here, the transmission and reception of MIDI messages is explained briefly.

□ MIDI connectors

Three connectors are used to transmit and receive MIDI messages. Connect the MIDI cables to these connectors according to your specific needs.

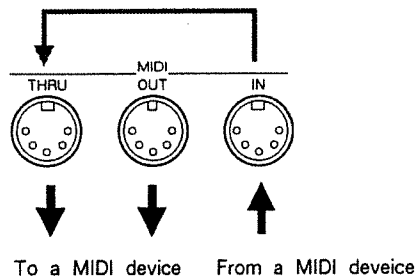

MIDI IN : This connector receives messages from another MIDI device.

MIDI OUT : This connector transmits messages originating from within the device.

MIDI THRU : This connector re - transmits the messages received at MIDI IN.

* Technically speaking, any number of MIDI devices can be connected using MIDI THRU connectors. The practical limit, however, is 5 units. This is because delay or deterioration of the MIDI signals will occur as the signal path becomes longer and longer.

* MIDI THRU outputs the MIDI messages received at MIDI IN1. The MIDI messages received at MIDI IN2 are not output.

□ MIDI channels and multi-timbral sound modules

MIDI transmits and receives performance data via one MIDI cable. This is possible because of MIDI channels. By using these MIDI channels, the data that is necessary can be selected from a large amount of data. MIDI channels are like television channels. By changing the television channel, programs from different stations can be seen. This is because the channels that send and receive the images are the same, and the program can be received. In a similar manner, MIDI messages are conveyed by matching the transmitting and receiving channels.

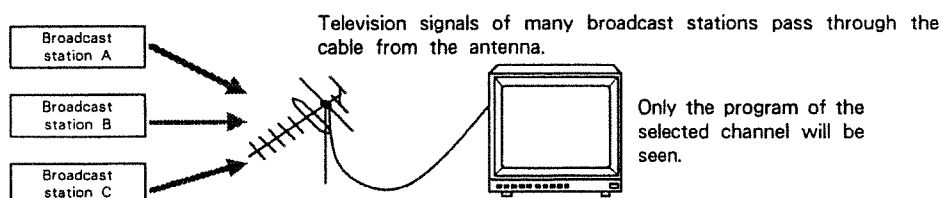

There are 16 MIDI channels. When the transmission channel and reception channel match, the performance data is transmitted. If the MIDI channel is set as shown below, only sound module B will sound when the keyboard is played; sound module A will not sound. This is because the transmission channel of the keyboard is matched only to sound module B.

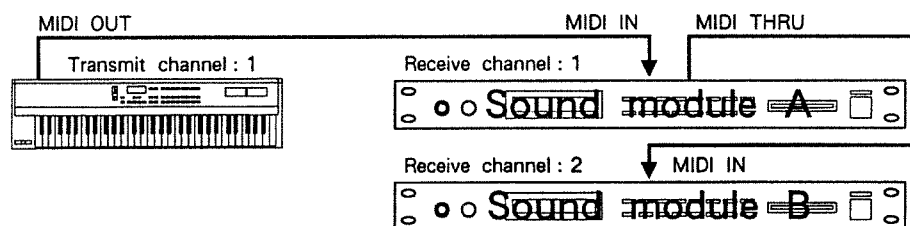

The SOUND Canvas can receive messages on 16 channels simultaneously, and play an ensemble of 16 parts (☞ P. 22). A sound source in which multiple parts can be played simultaneously is called a multi-timbral sound module.

The SOUND Canvas has “Normal” Parts and Drum Parts (☞ P. 24). These are called Part Mode. The Normal Part is used to play melodies or bass lines. In the Drum Part, the drum or percussion instruments are allocated to each note number. In a GM/GS sound module, channel 10 is reserved for the Drum Part.

* The SOUND Canvas can play up to 28 voices simultaneously. Therefore if the number of voices required exceeds 28, the sound may be cut off and the anticipated ensemble will not be achieved (☞ P.56).

[2] Using MIDI IN1 and IN2

The SOUND Canvas has two MIDI IN connectors: MIDI IN2 is on the front panel, and MIDI IN1 on the rear. The functions of these connectors differ slightly.

(1) Use MIDI IN1 to send MIDI data to a computer

If the MIDI IN1 - MIDI IN2 switch is off (factory setting), the data received by MIDI IN1 (rear panel) will be sent to the computer. The computer is connected to the SOUND Canvas with a serial cable.

* Note that the MIDI data will not be sent to the computer if the computer switch on the rear panel is set to "MIDI" (☞ P. 15).

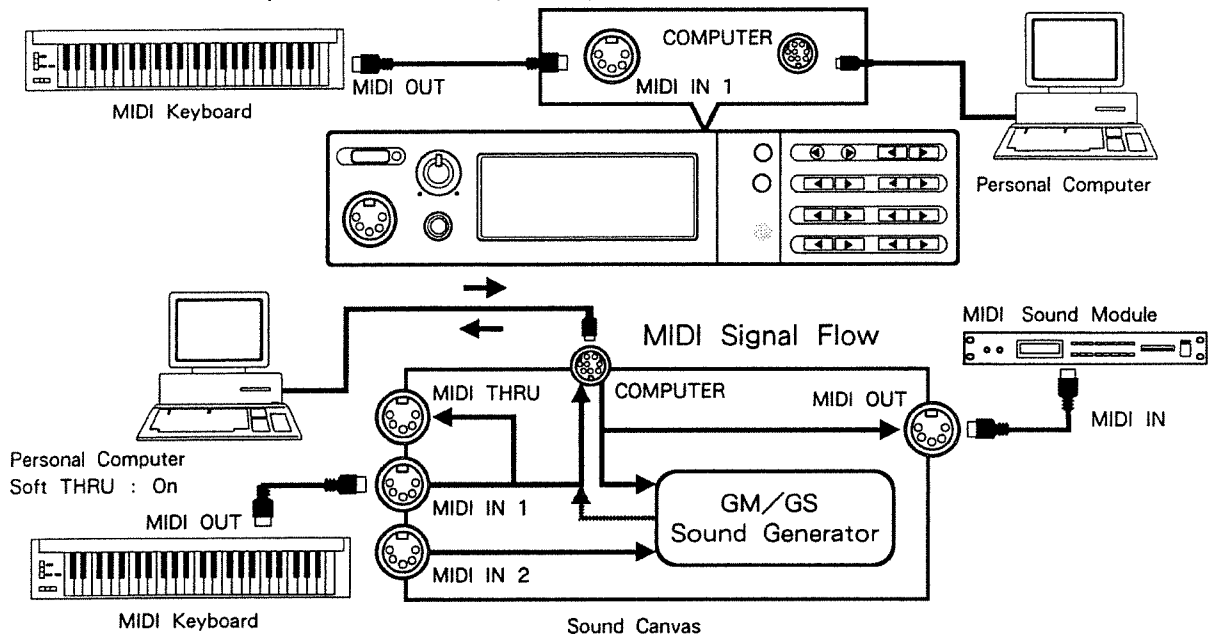

(2) Use MIDI IN2 for Minus - one play

Connect the MIDI keyboard to MIDI IN2 (front panel) to perform Minus - one play when the MIDI IN1 - MIDI IN2 switch is off (factory setting). The MIDI sequencer to be used for accompaniment is connected to MIDI IN1 (rear panel) (☞ P.34).

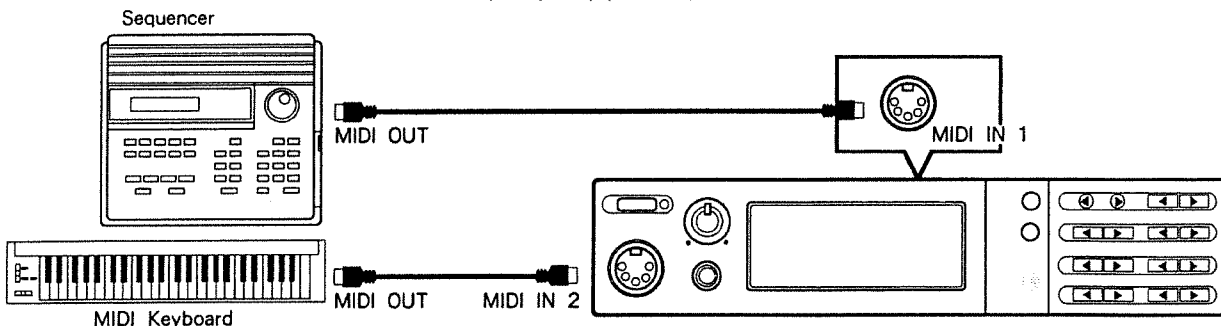

(3) Interchanging MIDI IN1 and IN2 functions

The MIDI IN1 and IN2 functions will be interchanged when the MIDI IN1 - IN2 switch is turned on. The connections of (1) and (2) above can be changed (☞ P.35).

* The MIDI IN1 - IN2 switch setting will be effective after the power is turned Off and then On again.

□ MIDI messages used by the SOUND Canvas

Various types of MIDI messages are used to convey a musical performance.

Channel messages are used to convey musical actions, such as “how hard a key was struck”(converted into a data format called MIDI messages). The action of the device (how to produce the sound, etc.) when the each MIDI message is received will depend on the specifications of that device. Therefore, if the function requested by a message is not included in the device, the desired effect may not be achieved.

* MIDI messages that must be received in the General MIDI system (level 1) are marked with a ☆.

● Note messages ☆

These messages convey the operation of the keyboard. The following messages are included in the note messages:

Note number	A number indicating the note (key) that was pressed or released
Note on	A message indicating that a note (key) was pressed
Note off	A message indicating that a note (key) was released
Velocity	A number indicating how strongly the note (key) was pressed

The note numbers 0 to 127 indicate the keyboard key position with C(C4) as 60.

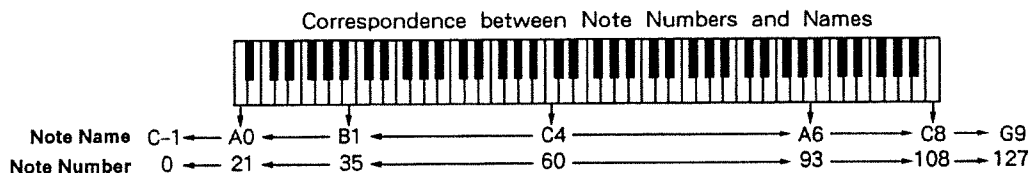

● Pitch bend change ☆

This message conveys the operation of the bender lever (or pitch bend wheel). The pitch will change when this message is received.

● Bank select (Control change number 0, 32)

● Program change ☆

These messages are generally used to change tones. The tones are selected with Program Numbers 1 to 128. In the SOUND Canvas, the Instrument (Variation) can be changed using Program Change messages. If a Bank Select (Control Change message) is used with a Program Change, more Variations can be selected (☞ P. 46).

● Control Change

These messages control the modulation and pan, etc. Each function is classified with a Control Change number.

Modulation (control change number 1) ☆

A vibrato effect is applied when this message is received.

Volume (control change number 7) ☆

This message conveys the volume level of the part. The part's volume will change when this message is received.

Expression (control change number 11) ☆

This message conveys the change in volume. This is used to lower or raise the volume during a song.

*The part volume will change with either the volume message (control change 7) or expression message (control change 11). Note that if a 0 value is received with either of the messages, the part volume will be 0, and the part's volume will not increase even with the other message.

Pan (control change number 10) ☆

This message conveys the part's pan (effect position during stereo output) (P. 26).

Hold (1) (control change number 64) ☆

This message conveys the pressing and releasing of the damper (sustain) pedal. Notes will be held when 'hold on' is received. Sounds which decay naturally (such as pianos) will decay more slowly when a 'hold on' is received. Sustaining sounds (such as organs) will be held until 'hold off' is received.

Sostenuto (control change number 66)

The pedal that sustains notes only when the pedal is pressed down is called the sostenuto pedal. This message conveys the action of pressing and releasing this pedal. When 'sostenuto on' is received, only notes played at the same time will be sustained. Sounds which decay naturally (such as pianos) will decay more slowly when a 'sostenuto on' is received. Sustaining sounds (such as organs) will be held until 'sostenuto off' is received.

Soft (control change number 67)

The pedal that softens the sound of notes played is called the soft pedal. This message conveys the action of pressing and releasing this pedal. When 'soft on' is received, the cut off frequency is lowered, and a soft sound is achieved. When 'soft off' is received, the original sound returns.

Reverb send level (control change number 91)

This message applies 'reverb' to a part.

Chorus send level (control change number 93)

This message applies 'chorus' to a part.

Portamento (control change number 65)

Portamento time (control change number 5)

Portamento control (control change number 84)

The portamento function smoothly changes the pitch from the last key pressed to the key currently being pressed. When portamento is received, the portamento effect is turned on or off. The speed of the pitch change is set with the portamento time. When portamento control is received, the Source Note number (key pressed last) is specified.

RPN LSB, MSB (control change number 100/101) ☆

Data entry (control change number 6/38) ☆

RPN (registered parameter numbers) functions are defined with the MIDI standards and can be used with different devices.

The parameter to be changed is specified with RPN MSB and RPN LSB, and the parameter value is set with the following data entry. The pitch bend sensitivity, master coarse tune and master fine tune values can be changed with RPN.

* The values changed with RPN will not be initialized even if the instrument is changed with a Program Change, etc.

NRPN LSB, MSB (control change number 98/99)

Data entry (control change number 6/38)

The device's characteristic variation parameters can be changed with the NRPN (non - registered parameter numbers). The parameter to be changed is specified in NRPN MSB and NRPN LSB, and the parameter value is set with the following data entry.

Common NRPN are set in the GS format, and the variation parameter can be changed using application software, etc., that is GS format compatible. The vibrato, cut off frequency, resonance, and envelope values can be changed with NRPN.

* The values change with NRPN will not be initialized even if the instruments is changed with a Program Change, etc.

* The specifications of the NRPN differs depending on the manufacturer. If an NRPN included in song data does not conform to the GS format, the data will not be played as expected. To play the song data from a different manufacturer, set the "NRPN Reception Switch" (☞ P.77) to OFF. When the SOUND Canvas receives the "GM system ON", it will automatically turn the "NRPN Reception Switch" off.

● **Aftertouch (Channel pressure ☆)**

Aftertouch refers to pressing down on a key after playing a note. The variation in aftertouch pressure can create changes in the sound produced. There are two types of aftertouch messages; Channel pressure and Polyphonic key pressure. Channel pressure affects all note numbers in the same MIDI channel. Polyphonic key pressure affects only the key (note number) that is pressed with the greatest force.

* The note will not be affected when an aftertouch message is received with the factory settings. Turn on aftertouch message reception on with an Exclusive message and specify what function to control with aftertouch (☞ P.100).

● All sounds off

This message turns off all sounds which are currently playing. The sounds in the corresponding channel will be turned off.

● All notes off ☆

This message turns all 'note on' messages to 'note off' messages. However, if hold 1 or sostenuto is turned on, the sound will not stop until these turn off.

● Reset all controllers ☆

These messages reset all controller values to their defaults.

Controller	Default value
Pitch bend change	0 (Center point)
Polyphonic key pressure	0 (Min.)
Channel key pressure	0 (Min.)
Modulation	0 (Min.)
Expression	0 (Max.)
Hold	0 (Off)
Portamento	0 (Off)
Soft	0 (Off)
Sostenuto	0 (Off)
RPN	State with no number set
NRPN	State with no number set

* Parameter values set with RPN and NRPN will not change even if reset all controllers is received.

● Active sensing

These messages monitor the integrity of MIDI connections. The SOUND Canvas will transmit Active sensing messages from its MIDI OUT. When the MIDI IN connector receives Active sensing messages, it will enter the 'Active sensing' mode. If Active sensing messages (or other MIDI messages) are not received at 420 millisecond intervals, the device will judge that a cable is disconnected or there is a damages connection. All sounds will be cut off, and a Reset all controllers message will be processed. Monitoring for Active sensing messages is terminated.

● System Exclusive messages

Exclusive messages are used to control a characteristic operation of the device. Universal system Exclusive messages can be used for all devices - regardless of the manufacturer. General Exclusive messages, however cannot convey data between different models.

Roland's Exclusive messages have a unique manufacturer ID, device ID and model ID so that the type of data can be determined. The SOUND Canvas's Exclusive messages have two model IDs; 42H for GS format and 45H for the SC - 55/SC - 55mk II /SC - 155. The two numbers are used according to the changed parameters. Note that data cannot be received or transmitted if the ID numbers do not match (☞ P. 76).

GM system on ☆ (Universal Non - Real Time System Exclusive)

When the GM 'system on' message is received, the General MIDI basic settings will be set. Reception of NRPN will not be possible if a GM 'system on' is received.

The GM 'system on' MIDI message is included at the beginning of song data that carries the GM mark. When the song data is played from the beginning, the device will be automatically initialized to the basic settings.

GS reset (GS format common System Exclusive)

When the GS reset message is received, the GS basic settings will be set. When GS reset is received, the NRPNs specified with the GS format can be received.

The GS reset MIDI message is included at the beginning of song data that carries the GS mark. When the song data is played from the beginning, the device will be automatically initialized to the basic settings.

Master volume (Universal Real Time System Exclusive)

This is a common universal Exclusive message for controlling the master volume of all parts. (☞ P.80)

Other Exclusive messages

The SOUND Canvas is compatible with the GS sound module common Exclusive messages (model ID 42H) set with the GS format. The Exclusive messages (model ID 45H) for the SC - 55/SC - 55mk II /SC - 155 can also be used. The SOUND Canvas settings can be saved and the parameters changed in detail using the Exclusive messages.

Parameters that can only be changed with Exclusive messages can be changed with the panel buttons using the micro Micro Edit function (☞ P.102). Refer to the section (from page 90) for details on the SOUND Canvas's Exclusive messages.

□ Changing the device ID number

Exclusive messages use device IDs (instead of channels) to separate messages. As with the MIDI channel, Exclusive data cannot be transmitted if the device IDs do not match.

Numbers 1 to 32 are set as possible device ID numbers. The factory preset setting is 17.

*The device ID number must be set to 17 to play Roland SMF music data. Normal playback will not be possible if set to another number.

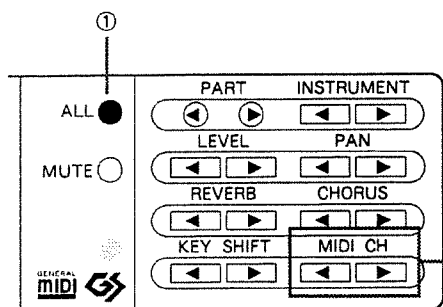

① Press **ALL** (so the button indicator lights).

② With the MIDI CH **◀▶** buttons, select the device ID number.

⇒When the MIDI CH **◀** and **▶** buttons are pressed simultaneously, the above setting will appear on the bar display. When pressed again simultaneously, the original display will return.

The device ID number

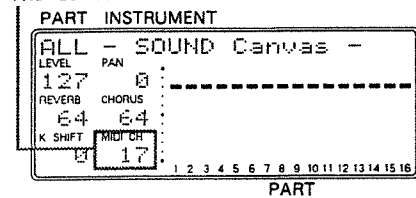

□ MIDI message reception switches

There are switches that prevent several MIDI messages from being received at once. The reception can be turned off with the buttons on the panel. There are “switches set for each part” and “switches common to all parts”.

<Switches for each part>

● NRPN reception switch

If the NRPN reception switch is turned off with, the parameter values will not change even if a message is received. This can be set for each part.

● Bank select reception switch

The bank select reception switch is on as a factory preset settings. If the bank select reception switch is turned off, the bank will not change even if a bank select message is received. This can be set for each part.

Mark when bank select reception switch is off.

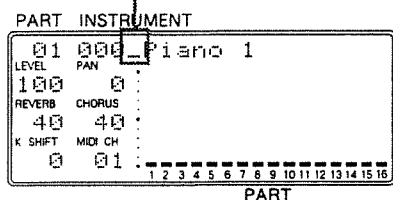

- * The bank select reception switch and NRPN reception switch will turn off when a GM system on message is received.
- * The bank select reception switch and NRPN reception switch will turn on when a GS reset message is received.
- * A “_ (underscore)” is displayed between the instrument number and instrument name when the bank select reception switch is off.

Turning on/off

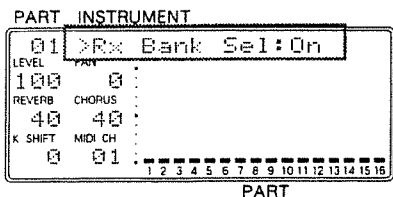
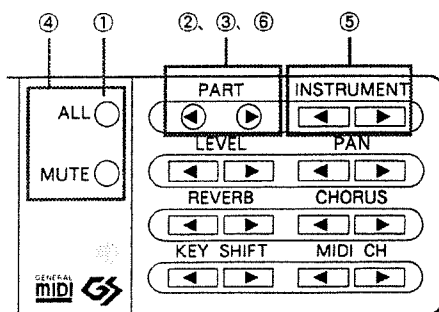

- ① Make sure that the **ALL** indicator is off. If the indicator is on, press the button to turn it off.
- ② Press the PART **◀▶** buttons simultaneously.
- ③ Use the PART **◀▶** buttons to select the part.
- ④ Select “Rx Bank Sel” or “Rx NRPN” with **ALL MUTE**.
- ⑤ Press INSTRUMENT **◀** for “Off”. Press INSTRUMENT **▶** for “On”.
- ⑥ After making the setting, complete the operation by pressing PART **◀▶** simultaneously.

<Switches common to all parts>

● Instrument reception switch

When the SOUND Canvas receives a Program Change message, the instrument (Variation) will change (☞ P.23, 46). Turn the instrument reception switch off when you do not want to change instruments with program change messages. When off, Program Changes will be invalid for the all parts, so the instrument and drum set cannot be changed with other MIDI devices.

● Exclusive reception switch

The SOUND Canvas settings will change when an Exclusive message is received. Turn the Exclusive reception switch off when the settings are not to be changed with Exclusive messages. Note that when off, all Exclusive messages sent will be ignored. For example, the GM system on/GS reset messages will be ignored, so GM/GS music data cannot be played properly.

● Function control reception switch

There are messages in the SOUND Canvas's Exclusive data that function in the same manner as the buttons on the panel. If the function control reception switch is turned on and a designated Exclusive message is sent to the SOUND Canvas, Minus - one play and part mute can be turned on/off. Refer to the MIDI implementation (☞ P.94,97) for details on transmission methods.

When the function control reception switch is turned off, the SOUND Canvas will ignore these messages.

*The function control reception switch is set to ON at the factory.

*Even if the function control reception switch is turned on and the Exclusive reception switch is turned off, Exclusive messages will be invalidated by the function control.

The parameters affected by the function control reception switch are shown below.

Parameter name	Button operation
Part select	PART ◀ . ▶
Minus - one	PART ◀ . ▶ → LEVEL ◀ * REVERB ◀
Part monitor	PART ◀ . ▶ → ALL * MUTE
All mute	ALL (the indicator turn on) → MUTE
Part mute	ALL (the indicator turn off) → PART ◀ ▶ → MUTE

→ : Move to next operation

* : Press simultaneously

● GM system on/GS reset reception switch

When the SOUND Canvas receives a GM system on/GS reset MIDI message (☞ P.75), the settings change to the GM/GS basic settings. Song data bearing the GM/GS mark has a GM system on/GS reset MIDI message at the beginning of the data. If the song data is played from the beginning, the settings will automatically be initialized to the basic settings.

To ignore the GM system on/GS reset MIDI messages, turn the GM system on/GS reset reception switch off. (☞ P.79) The factory preset setting is on.

* If the exclusive reception switch (☞ P.79) is turned off and the above settings are turned on, the GM system on/GS reset will be ignored.

Turning on/off

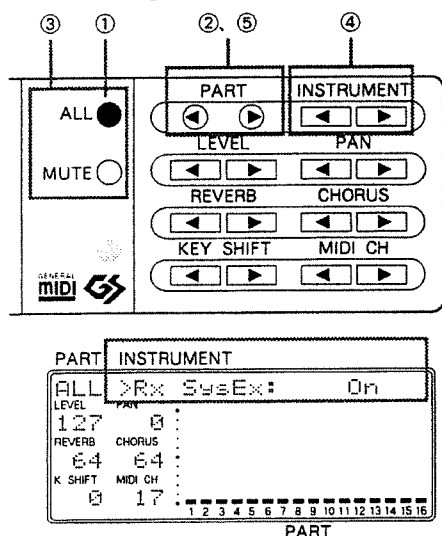

- ① Press **ALL** so the button indicator lights.
- ② Press the **PART** buttons simultaneously.
- ③ Select the function with **ALL** **MUTE**.
 - "Rx SysEx" (Exclusive reception switch)
 - "Rx GM On" (GM system on reception switch)
 - "Rx GS Reset" (GS reset reception switch)
 - "Rx Inst Chg" (Instrument reception switch)
 - "Rx FuncCtrl" (Function control reception switch)
- ④ Press **INSTRUMENT** for "Off".
Press **INSTRUMENT** for "On".
- ⑤ After making the setting, complete the operation by pressing **PART** simultaneously.

□ The send select switch for the Universal Master Volume

When sending the Master Volume messages for all Parts using the GS Setup send function (☞ P.58), you can send them as Universal Realtime Exclusive messages. To do so, turn on the “Use Univ. Rt”, then execute GS setup send. If you execute GS setup send when the “Use Univ. Rt” is set to off, the Master Volume messages for all Parts will not be sent as Universal Realtime Exclusive messages but sent as GS Format’s Exclusive messages.

Turning on/off

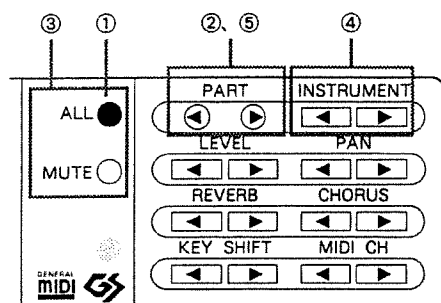

- ① Press **ALL** and light the button indicator.
- ② Press the PART **◀ ▶** buttons simultaneously.
- ③ Select the “Use Univ. Rt” (Use of Universal Realtime Exclusive Switch) using **ALL** and **MUTE**.
- ④ Press INSTRUMENT **◀** to select “Off”. Press INSTRUMENT **▶** to select “On”.
- ⑤ After the setting is done, complete the operation by pressing PART **◀ ▶** simultaneously.

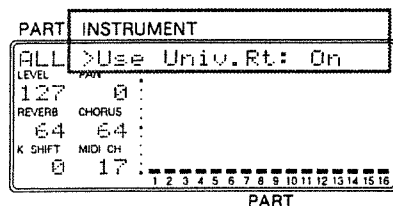

About MIDI implementation charts

Using MIDI, various electronic musical instruments can be connected and played together. However, in some cases, there are MIDI messages that cannot be transmitted or received. For example, when controlling with aftertouch, if the connected sound module does not respond to aftertouch, that affect cannot be achieved. Only messages that are compatible with both MIDI devices can be transmitted or received.

The “MIDI implementation chart” (☞P.105) shows the MIDI messages that can actually be used. When looking at the transmission column of the transmitting device and the reception column of the receiving device, those messages that both have an “O” can be used. If either of the columns has an “X”, the message cannot be transmitted/received.

Refer to the section (from page 90) for details of the SOUND Canvas’s MIDI implementation (such as the Exclusive message data format).

THE GENERAL MIDI SYSTEM AND GS FORMAT



What is the General MIDI System?

The General MIDI System is a universal set of specifications for sound generating devices which has been agreed upon by both the Japanese MIDI Standards Committee and the American MMA (MIDI Manufacturer's Association). These specifications seek to allow for the creation of music data which is not limited to equipment by a particular manufacturer or to specific models.

The General MIDI System defines things such as the minimum number of voices that should be supported, the MIDI messages that should be recognized, which sounds correspond to which Program Change numbers, and the layout of rhythm sounds on the keyboard. Thanks to these specifications, any device that is equipped with sound sources supporting the General MIDI System will be able to accurately reproduce General MIDI Scores (music data created for the General MIDI System), regardless of the manufacturer or model.



What is the GS Format?

The GS Format is a standardized set of specifications for Roland's sound sources which defines the manner in which multi-timbral sound generating units will respond to MIDI messages. The GS Format also complies with the General MIDI System.

The GS Format also defines a number of other details. These include unique specifications for sounds and the functions available for Tone editing and effects (chorus and reverb), and other specifications concerning the manner in which sound sources will respond to MIDI messages.

Any device that is equipped with GS Format sound sources can faithfully reproduce GS Music Data (music data created under the GS Format).

This product supports both General MIDI and GS.

Song data which carries either of these logos can be accurately reproduced.

When you play the GM Score data, be sure to set the GM System On Switch to ON and the Exclusive Receiving Switch to ON (☞ P.79)

When you play Roland SMF Music data, be sure to set the Device ID number (☞ P.76) to 17, the GS Reset Receiving Switch to ON and the Exclusive Receiving Switch to ON(☞ P.79).

The default settings are as above.

COMPUTER CABLE WIRING DIAGRAM

Apple Macintosh (Sold separately: RSC - 15APL)
(RS - 422)

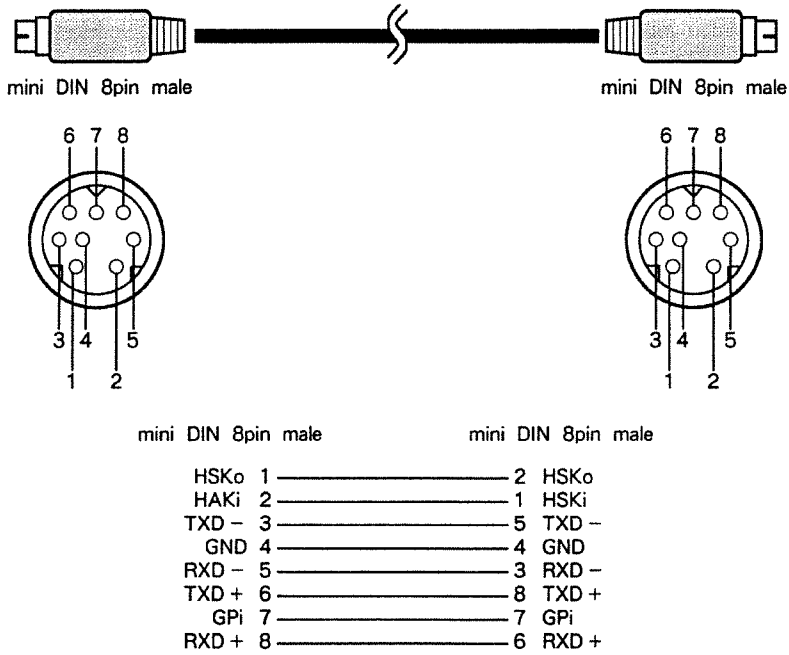

IBM PC/AT (9 - pin) (Sold separately: RSC - 15AT)
(RS232C - 2)

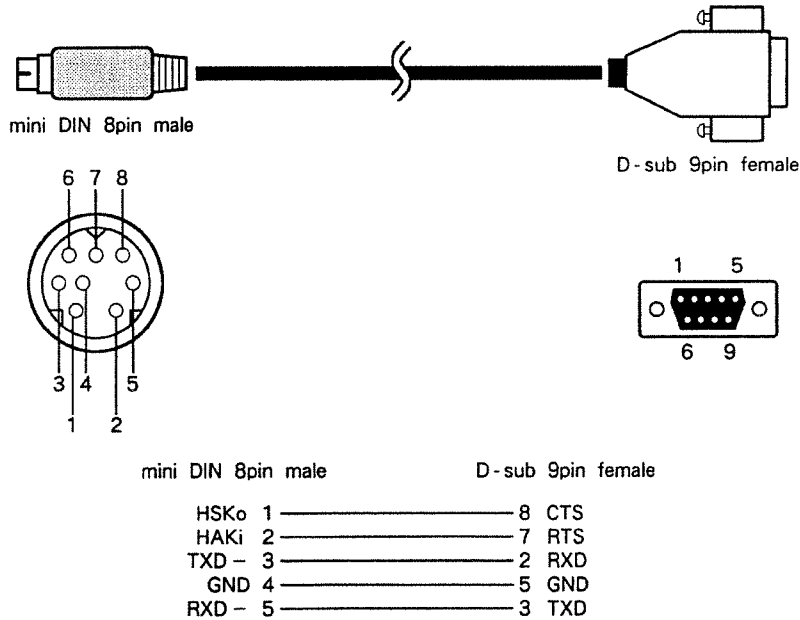

IBM PC/AT (25 - pin)
(RS232C - 2)

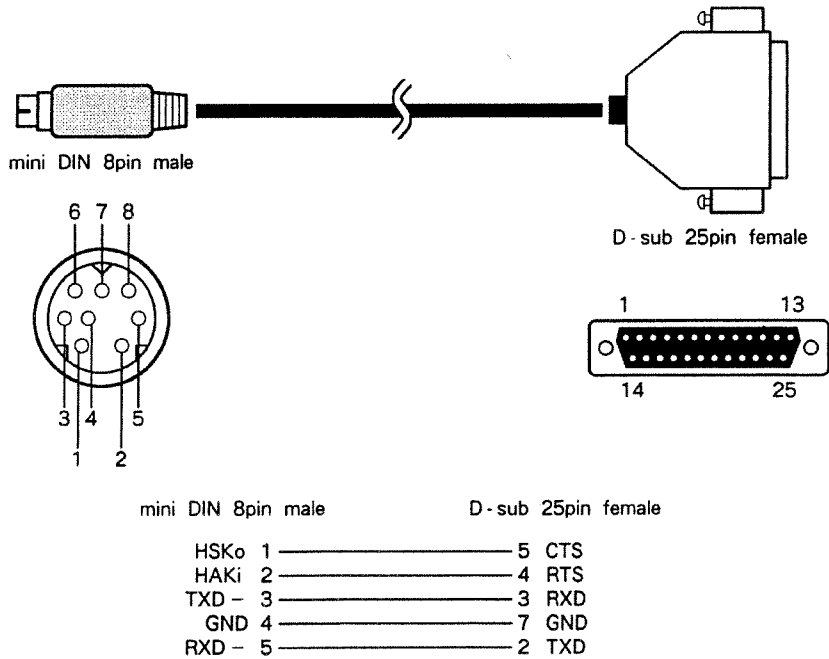

INSTRUMENT TABLE

	PC	CC0	Instrument name	V		PC	CC0	Instrument name	V
Piano	1	0	Piano 1	1	Organ	20	0	Church Org.1	1
		8	Piano 1w	1			8	Church Org.2	2
		16	Piano 1d	1			16	Church Org.3	2
	2	0	Piano 2	1		21	0	Reed Organ	1
		8	Piano 2w	1		22	0	Accordion Fr	2
	3	0	Piano 3	1		8	Accordion It	2	
		8	Piano 3w	1		23	0	Harmonica	1
	4	0	Honky-tonk	2		24	0	Bandoneon	2
		8	Honky-tonk w	1		Guitar	25	0	Nylon-str. Gt.
	5	0	E. Piano 1	1				8	Ukulele
		8	Detuned EP 1	2	16			Nylon Gt.o	2
		16	E. Piano 1v	2	32			Nylon Gt.2	1
		24	60's E. Piano	1	26		0	Steel-str. Gt.	1
	6	0	E. Piano 2	1			8	12-str. Gt.	2
		8	Detuned EP 2	2			16	Mandolin	1
		16	E. Piano 2v	2	27		0	Jazz Gt.	1
	7	0	Harpsichord	1			8	Hawaiian Gt.	1
		8	Coupled Hps.	2	28		0	Clean Gt.	1
		16	Harpsi.w	1		8	Chorus Gt.	2	
		24	Harpsi.o	2	29	0	Muted Gt.	1	
Chromatic Percussion	8	Clav.	1	8		Funk Gt.	1		
	16	Funk Gt.2	1	30		0	Overdrive Gt.	1	
	24	Overdrive Gt.	1		31	0	Distortion Gt.	1	
	0	Celesta	1	8		Feedback Gt.	2		
	0	Glockenspiel	1	32	0	Gt. Harmonics	1		
	0	Music Box	1		8	Gt. Feedback	1		
	0	Vibraphone	1	Bass	33	0	Acoustic Bs.	1	
	8	Vib.w	1			0	Fingered Bs.	1	
	0	Marimba	1		34	0	Picked Bs.	1	
	8	Marimba w	1			0	Fretless Bs.	1	
0	Xylophone	1	35			0	Slap Bass 1	1	
8	Xylophone	1				0	Slap Bass 2	1	
0	Tubular-bell	1	36		0	Synth Bass 1	1		
15	8	Church Bell			1	1	Synth Bass 101	1	
	9	Carillon			1	8	Synth Bass 3	1	
	0	Santur	1		37	0	Synth Bass 2	2	
17	0	Organ 1	1	8		Synth Bass 4	2		
	8	Detuned Or. 1	2	38		16	Rubber Bass	2	
	16	60's Organ 1	1			39	0	Synth Bass 1	1
	32	Organ 4	2	1	Synth Bass 101		1		
18	0	Organ 2	1	8	Synth Bass 3	1			
	8	Detuned Or. 2	2	40	0	Synth Bass 2	2		
	32	Organ 5	2		8	Synth Bass 4	2		
	0	Organ 3	2	16	Rubber Bass	2			

PC : Program change number (Instrument number)
 CC0 : Value of control number 0 (Variation number)
 V : Number of voices

Recommended sound range :
 The recommended sound range does not indicate the limit of sound production. The actual playable range extends beyond the recommended sound range.

	PC	CC0	Instrument name	V
Strings/orchestra	41	0	Violin	1
		8	Slow Violin	1
	42	0	Viola	1
	43	0	Cello	1
	44	0	Contrabass	1
	45	0	Tremolo Str	1
	46	0	PizzicatoStr	1
	47	0	Harp	1
	48	0	Timpani	1
Ensemble	49	0	Strings	1
		8	Orchestra	2
	50	0	Slow Strings	1
	51	0	Syn. Strings1	1
		8	Syn. Strings3	2
	52	0	Syn. Strings2	2
	53	0	Choir Aahs	1
		32	Choir Aahs 2	1
	54	0	Voice Oohs	1
55	0	SynVox	1	
56	0	OrchestraHit	2	
Brass	57	0	Trumpet	1
		0	Trombone	1
	58	1	Trombone 2	2
		59	0	Tuba
	60	0	MutedTrumpet	1
	61	0	French Horn	2
		1	Fr. Horn	2
	62	0	Brass 1	1
		8	Brass 2	2
	63	0	Synth Brass1	2
		8	Synth Brass3	2
	64	16	AnalogBrass1	2
		0	Synth Brass2	2
		8	Synth Brass4	1
		16	AnalogBrass2	2

	PC	CC0	Instrument name	V
Reed	65	0	Soprano Sax	1
	66	0	Alto Sax	1
	67	0	Tenor Sax	1
	68	0	Baritone Sax	1
	69	0	Oboe	1
	70	0	English Horn	1
	71	0	Bassoon	1
	72	0	Clarinet	1
	73	0	Piccolo	1
	74	0	Flute	1
Pipe	75	0	Recorder	1
	76	0	Pan Flute	1
	77	0	Bottle Blow	2
	78	0	Shakuhachi	2
	79	0	Whistle	1
	80	0	Ocarina	1
	Synth lead	81	0	Square Wave
1			Square	1
8			Sine Wave	1
82		0	Saw Wave	2
		1	Saw	1
		8	Doctor Solo	2
83		0	Syn. Calliope	2
84		0	Chiffer Lead	2
85		0	Charang	2
86		0	Solo Vox	2
87	0	5th Saw Wave	2	
88	0	Bass & Lead	2	
Synth pad etc.	89	0	Fantasia	2
	90	0	Warm Pad	1
	91	0	Polysynth	2
	92	0	Space Voice	1
	93	0	Bowed Glass	2
	94	0	Metal Pad	2
	95	0	Halo Pad	2
	96	0	Sweep Pad	1

PC : Program change number (Instrument number)
 CC0 : Value of control number 0 (Variation number)
 V : Number of voices

■ INSTRUMENT TABLE

	PC	CC0	Instrument name	V
Synth SFX	97	0	Ice Rain	2
	98	0	Soundtrack	2
	99	0	Crystal	2
	100	0	Atmosphere	2
	101	0	Brightness	2
	102	0	Goblin	2
	103	0	Echo Drops	1
	104	0	Star Theme	2
Ethnic	105	0	Sitar	1
	106	0	Banjo	1
	107	0	Shamisen	1
	108	0	Koto	1
		8	Taisho Koto	2
	109	0	Kalimba	1
	110	0	Bag Pipe	1
	111	0	Fiddle	1
112	0	Shanai	1	
Percussive	113	0	Tinkle Bell	1
	114	0	Agogo	1
	115	0	Steel Drums	1
	116	0	Woodblock	* 1
		8	Castanets	* 1
	117	0	Taiko	* 1
		8	Concert BD	* 1
	118	0	Melo Tom 1	* 1
		8	Melo Tom 2	* 1
	119	0	Synth Drum	* 1
8		808 Tom	* 1	
120	0	Reverse Cym.	* 2	

PC : Program change number (Instrument number)
 CC0 : Value of control number 0 (Variation number)
 V : Number of voices
 * : All tones marked by an * have an unreliable pitch.
 Please use a key around C4 (Note number 60).
 The unmarked tones use temperament and pitch
 of A4 (Note number 69) is tuned to be the same
 as the Master Tune.

	PC	CC0	Instrument name	V
SFX	121	0	Gt. FretNoise	* 1
		1	Gt. Cut Noise	* 1
		2	String Slap	* 1
	122	0	Breath Noise	2
		1	Fl. Key Click	* 1
	123	0	Seashore	* 1
		1	Rain	* 2
		2	Thunder	* 1
		3	Wind	* 1
		4	Stream	* 2
	124	5	Bubble	* 2
		0	Bird	* 2
		1	Dog	* 1
	125	2	Horse - Gallop	* 1
		0	Telephone 1	* 1
		1	Telephone 2	* 1
		2	Door Creaking	* 1
		3	Door	* 1
	126	4	Scratch	* 1
		5	Windchime	* 2
		0	Helicopter	* 1
		1	Car - Engine	* 1
		2	Car - Stop	* 1
		3	Car - Pass	* 1
		4	Car - Crash	* 2
		5	Siren	* 1
		6	Train	* 1
	127	7	Jetplane	* 2
		8	Starship	* 2
		9	Burst Noise	* 2
0		Applause	* 2	
1		Laughing	* 1	
128	2	Screaming	* 1	
	3	Punch	* 1	
	4	Heart Beat	* 1	
	5	Footsteps	* 1	
	0	Gun Shot	* 1	
128	1	Machine Gun	* 1	
	2	Lasergun	* 1	
	3	Explosion	* 2	

● MT - 32 set (Variation : 127)

PC	Instrument name	V	PC	Instrument name	V	PC	Instrument name	V	PC	Instrument name	V
1	Acou Piano 1	1	33	Fantasy	2	65	Acou Bass 1	1	97	Brs Sect 2	2
2	Acou Piano 2	1	34	Harmo Pan	2	66	Acou Bass 2	1	98	Vibe 1	1
3	Acou Piano 3	1	35	Chorale	1	67	Elec Bass 1	1	99	Vibe 2	1
4	Elec Piano 1	1	36	Glasses	2	68	Elec Bass 2	1	100	Syn Mallet	1
5	Elec Piano 2	1	37	Soundtrack	2	69	Slap Bass 1	1	101	Windbell	2
6	Elec Piano 3	1	38	Atmosphere	2	70	Slap Bass 2	1	102	Glock	1
7	Elec Piano 4	1	39	Warm Bell	2	71	Fretless 1	1	103	Tube Bell	1
8	Honkytonk	2	40	Funny Vox	1	72	Fretless 2	1	104	Xylophone	1
9	Elec Org 1	1	41	Echo Bell	2	73	Flute 1	1	105	Marimba	1
10	Elec Org 2	2	42	Ice Rain	2	74	Flute 2	1	106	Koto	1
11	Elec Org 3	1	43	Oboe 2001	2	75	Piccolo 1	1	107	Sho	2
12	Elec Org 4	1	44	Echo Pan	2	76	Piccolo 2	2	108	Shakuhachi	2
13	Pipe Org 1	2	45	Doctor Solo	2	77	Recorder	1	109	Whistle 1	2
14	Pipe Org 2	2	46	School Daze	1	78	Pan Pipes	1	110	Whistle 2	1
15	Pipe Org 3	2	47	Bellsinger	1	79	Sax 1	1	111	Bottleblow	2
16	Accordion	2	48	Square Wave	2	80	Sax 2	1	112	Breathpipe	1
17	Harpsi 1	1	49	Str Sect 1	1	81	Sax 3	1	113	Timpani	1
18	Harpsi 2	2	50	Str Sect 2	1	82	Sax 4	1	114	Melodic Tom	1
19	Harpsi 3	1	51	Str Sect 3	1	83	Clarinet 1	1	115	Deep Snare	1
20	Clavi 1	1	52	Pizzicato	1	84	Clarinet 2	1	116	Elec Perc 1	1
21	Clavi 2	1	53	Violin 1	1	85	Oboe	1	117	Elec Perc 2	1
22	Clavi 3	1	54	Violin 2	1	86	Engl Horn	1	118	Taiko	1
23	Celesta 1	1	55	Cello 1	1	87	Bassoon	1	119	Taiko Rim	1
24	Celesta 2	1	56	Cello 2	1	88	Harmonica	1	120	Cymbal	1
25	Syn Brass 1	2	57	Contrabass	1	89	Trumpet 1	1	121	Castanets	1
26	Syn Brass 2	2	58	Harp 1	1	90	Trumpet 2	1	122	Triangle	1
27	Syn Brass 3	2	59	Harp 2	1	91	Trombone 1	2	123	Orche Hit	1
28	Syn Brass 4	2	60	Guitar 1	1	92	Trombone 2	2	124	Telephone	1
29	Syn Bass 1	1	61	Guitar 2	1	93	Fr Horn 1	2	125	Bird Tweet	1
30	Syn Bass 2	2	62	Elec Gtr 1	1	94	Fr Horn 2	2	126	One Note Jam	1
31	Syn Bass 3	2	63	Elec Gtr 2	1	95	Tuba	1	127	Water Bell	2
32	Syn Bass 4	1	64	Sitar	2	96	Brs Sect 1	1	128	Jungle Tune	2

PC : Program change number (Instrument number)

V : Number of voices

※ Variation 127 is set to the same sound arrangement of the MT-32 (Roland Multi-Timbral Sound Module). The setting of the pitch bend range, modulation depth, etc, are however different from that of the MT-32. Pan directions are reversed from an actual MT-32, so to rectify this situation reverse the L/R connections of the Audio Output jacks.

※ If Exclusive messages of the MT-32 are received by the SOUND Canvas, the settings of the latter will not be changed.

DRUM SET TABLE

Note number	PC 1:STANDARD Set / PC 33:JAZZ Set	PC 9:ROOM Set	PC 17:POWER Set	PC 25: ELECTRONIC Set	PC 26:TR - 808 Set	PC 41: BRUSH Set	PC 49:ORCHESTRA Set
28	27 High Q						Closed Hi-Hat [EXC1]
	Slap						Pedal Hi-Hat [EXC1]
29	Scratch Push [EXC7]						Open Hi-Hat [EXC1]
30	Scratch Pull [EXC7]						Ride Cymbal
31	Slicks						
32	Square Click						
33	Metronome Click						
34	Metronome Bell						
35	Kick Drum 2 / Jazz BD2					Jazz BD2	Concert BD 2
36	Kick Drum 1 / Jazz BD1		MONDO Kick	Elec BD	808 Bass Drum	Jazz BD1	Concert BD 1
37	Side Stick				808 Rim Shot		
38	Snare Drum 1		Gated SD	Elec SD	808 Snare Drum	Brush Tap	Concert SD
39	Hand Clap					Brush Slap	Castanets
40	Snare Drum 2			Gated SD		Brush Swirl	Concert SD
41	Low Tom 2	Room Low Tom 2	Room Low Tom 2	Elec Low Tom 2	808 Low Tom 2		Timpani F
42	Closed Hi - hat [EXC1]				808 CHH [EXC1]		Timpani F#
43	Low Tom 1	Room Low Tom 1	Room Low Tom 1	Elec Low Tom 1	808 Low Tom 1		Timpani G
44	Pedal Hi - hat [EXC1]				808 CHH [EXC1]		Timpani G#
45	Mid Tom 2	Room Mid Tom 2	Room Mid Tom 2	Elec Mid Tom 2	808 Mid Tom 2		Timpani A
46	Open Hi - hat [EXC1]				808 OHH [EXC1]		Timpani A#
47	Mid Tom 1	Room Mid Tom 1	Room Mid Tom 1	Elec Mid Tom 1	808 Mid Tom 1		Timpani B
48	High Tom 2	Room Hi Tom 2	Room Hi Tom 2	Elec Hi Tom 2	808 Hi Tom 2		Timpani c
49	Crash Cymbal 1				808 Cymbal		Timpani c#
50	High Tom 1	Room Hi Tom 1	Room Hi Tom 1	Elec Hi Tom 1	808 Hi Tom 1		Timpani d
51	Ride Cymbal 1						Timpani d#
52	Chinese Cymbal			Reverse Cymbal ★			Timpani e
	Ride Bell						Timpani f
53	54 Tambourine						
55	Splash Cymbal						
56	Cowbell				808 Cowbell		
57	Crash Cymbal 2						Concert Cymbal 2
58	Vibra - slap						
59	Ride Cymbal 2						Concert Cymbal 1
60	High Bongo						
61	Low Bongo						
62	Mute High Conga				808 High Conga		
63	Open High Conga				808 Mid Conga		
64	Low Conga				808 Low Conga		
65	High Timbale						
66	Low Timbale						
67	High Agogo						
68	Low Agogo						
69	Cabasa						
70	Maracas				808 Maracas		
71	Short Hi Whistle [EXC2]						
72	Long Low Whistle [EXC2]						
73	Short Guiro [EXC3]						
74	Long Guiro [EXC3]						
75	Claves				808 Claves		
76	High Wood Block						
77	Low Wood Block						
78	Mute Cuica [EXC4]						
79	Open Cuica [EXC4]						
80	Mute Triangle [EXC5]						
81	Open Triangle [EXC5]						
82	Shaker						
83	Jingle Bell						
84	Bell Tree						
85	Castanets						
86	Mute Surdo [EXC6]						
87	Open Surdo [EXC6]						
88							Applause ★

PC : Program change number (drum set number)
 ★ : Tones which are created using two voices.
 (All other tones are created by one voice.)

Blank : Same as the percussion sound of "STANDARD"
 - - - - - : No sound
 [EXC] : Percussion sound of the same number will not be heard at the same time.

● SFX set (Program number 57)

Note number	PC 57:SFX Set
39	High Q
40	Slap
41	Scratch Push (EXC 7)
42	Scratch Pull (EXC 7)
43	Slicks
44	Square Click
45	Metronome Click
46	Metronome Bell
47	Guitar sliding finger
48	Guitar cutting noise (down)
49	Guitar cutting noise (up)
50	String slap of double bass
51	Fl. Key Click
52	Laughing
53	Screaming
54	Punch
55	Heart Beat
56	Footsteps1
57	Footsteps2
58	Applause ★
59	Door Creaking
60	Door
61	Scratch
62	Windchime ★
63	Car-Engine
64	Car-Stop
65	Car-Pass
66	Car-Crash ★
67	Siren
68	Train
69	Jetplane ★
70	Helicopter ★
71	Starship ★
72	Gun Shot
73	Machine Gun
74	Lasergun
75	Explosion ★
76	Dog
77	Horse-Gallop
78	Birds ★
79	Rain ★
80	Thunder
81	Wind
82	Seashore
83	Stream ★
84	Bubble ★

- ★ : Tones which are created using two voices.
(All other tones are created by one voice.)
- : No sound
- [EXC] : Percussion sounds of the same number cannot be heard at the same time.

※ The CM-64/32L set is the MT-32 drum set with SFX sounds added.

● CM - 64/32L set (Program number 128)

Note number	PC 128:CM-64/32L Set
34	-----
35	Acoustic Bass Drum
36	Acoustic Bass Drum
37	Rim Shot
38	Acoustic Snare Drum
39	Hand Clap
40	Electronic Snare Drum
41	Acoustic Low Tom
42	Closed High Hat [EXC1]
43	Acoustic Low Tom
44	Open High Hat 2
45	Acoustic Middle Tom
46	Open High Hat 1 [EXC1]
47	Acoustic Middle Tom
48	Acoustic High Tom
49	Crash Cymbal
50	Acoustic High Tom
51	Ride Cymbal
52	-----
53	-----
54	Tambourine
55	-----
56	Cowbell
57	-----
58	-----
59	-----
60	High Bongo
61	Low Bongo
62	Mute High Conga
63	High Conga
64	Low Conga
65	High Timbale
66	Low Timbale
67	High Agogo
68	Low Agogo
69	Cabasa
70	Maracas
71	Short Whistle
72	Long Whistle
73	Oujada
74	-----
75	Claves
76	Laughing
77	Screaming
78	Punch
79	Heartbeat
80	Footsteps 1
81	Footsteps 2
82	Applause ★
83	Creaking
84	Door
85	Scratch
86	Windchime ★
87	Engine
88	Car-Stop
89	Car-Pass
90	Crash ★
91	Siren
92	Train
93	Jet ★
94	Helicopter ★
95	Starship ★
96	Pistol
97	Machine Gun
98	Lasergun
99	Explosion ★
100	Dog
101	Horse-Gallop
102	Birds ★
103	Rain ★
104	Thunder
105	Wind
106	Waves
107	Stream ★
108	Bubble ★

1. Receive data**■ Channel Voice Messages**

When the MINUS ONE function is set to ON, the MIDI channel number of the message from MIDI IN 2 is converted to that of the selected part.

● Note off

Status	Second	Third
8nH	kkH	vvH
9nH	kkH	00H

n = MIDI channel number : 0H - FH (ch.1 - ch.16)
 kk = Note number : 00H - 7FH (0 - 127)
 vv = Velocity : 00H - 7FH (0 - 127)

- *Ignored when "Rx.Note message = OFF".
- *In the drum part, ignored when "Rx.Note off = Off" for each instrument.
- *Velocity is ignored.
- *Ignored when the MINUS ONE function is set to ON and the MIDI channel number of the message from MIDI IN is the same as the selected part.

● Note on

Status	Second	Third
9nH	kkH	vvH

n = MIDI channel number : 0H - FH (ch.1 - ch.16)
 kk = Note number : 00H - 7FH (0 - 127)
 vv = Velocity : 01H - 7FH (1 - 127)

- *Ignored when "Rx.Note message = OFF".
- *In the drum part, ignored when "Rx.Note on = OFF" for each instrument.
- *Ignored when the MINUS ONE function is set to ON and the MIDI channel number of the message from MIDI IN is the same as the selected part.

● Polyphonic key pressure

Status	Second	Third
AnH	kkH	vvH

n = MIDI channel number : 0H - FH (ch.1 - ch.16)
 kk = Note number : 00H - 7FH (0 - 127)
 vv = Value : 00H - 7FH (0 - 127)

- *Ignored when "Rx.POLY PRESSURE (PAF) = OFF".
- *Effect to the parameter set on "PAF controller function". The default setting has no effect.
- *Ignored when the MINUS ONE function is set to ON and the MIDI channel number of the message from MIDI IN is the same as the selected part.

● Control change

- *Ignores all control change messages (other than channel mode messages) when "Rx.Control change = OFF".
- *The values set by Control change messages won't be reset by receiving new Program change messages.

○ Bank select

Status	Second	Third
BnH	00H	mmH
BnH	20H	llH

n = MIDI channel number : 0H - FH (ch.1 - ch.16)
 mm,ll = Bank number : 00H,00H - 7FH,7FH (bank1 - bank16384)
 Default Value = 00 00H (bank.1)

- *Ignored when "Rx.Bank Select = OFF".
- "Rx.Bank Select" is set to OFF by "Turn General MIDI System On".
- *The LSB 7 - bits are ignored (always regards as llH = 00H) in this Model. However, when sending Bank Select messages, you have to send both the MSB (mm) and LSB (ll) together.
- *"Bank select" is suspended until receiving "Program change". To select a Timbre of another bank, you have to send a Bank select (mm, ll) before sending the Program change.
- *The "Variation number" of GS Format is defined as the decimal expression of the MSB value (Control change number 00H) of the Bank select.
- *Ignored when "Rx.Inst Chg : Off" or USER function (⌘P.28) is ON.
- *In Drum Parts, Bank Select messages will be ignored.

○ Modulation

Status	Second	Third
BnH	01H	vvH

n = MIDI channel number : 0H - FH (ch.1 - ch.16)
 vv = Modulation depth : 00H - 7FH (0 - 127)

- *Ignored when "Rx.Modulation = OFF".
- *Effect to the parameter set on "MOD controller function". The default setting is pitch modulation depth.
- *Ignored when the MINUS ONE function is set to ON and the MIDI channel number of the message from MIDI IN is the same as the selected part.

○ Portamento time

Status	Second	Third
BnH	05H	vvH

n = MIDI channel number : 0H - FH (ch.1 - ch.16)
 vv = Portamento time : 00H - 7FH (0 - 127)
 Default Value = 00H (0)

- *The Portamento time value changes the rate of pitch change when Portamento is ON or when using portamento control messages. Value 0 is the fastest.

○ Data entry

Status	Second	Third
BnH	06H	mmH
BnH	26H	llH

n = MIDI channel number : 0H - FH (ch.1 - ch.16)
 mm,ll = Value of the parameter specified with RPN and/or NRPN

○ Volume

Status	Second	Third
BnH	07H	vvH

n = MIDI channel number : 0H - FH (ch.1 - ch.16)
 vv = Volume : 00H - 7FH (0 - 127)

- *Volume messages control the volume level of the specified channel (part). Use Volume messages to control volume balance of each part.
- *Ignored when "Rx.Volume = OFF".
- *Ignored when USER function (⌘P.28) is ON.

○ Panpot

Status	Second	Third
BnH	0AH	vvH

n = MIDI channel number : 0H - FH (ch.1 - ch.16)
 vv = Panpot : 00H - 40H - 7FH (Left - Center - Right)

- *127 steps from Left to Center to Right.
- *Within the Drum Part, the panpot provides overall control of a stereophonic image.
- *Ignored when "Rx.Panpot = OFF".
- *Ignored when USER function (⌘P.28) is ON.

○ Expression

Status	Second	Third
BnH	0BH	vvH

n = MIDI channel number : 0H - FH (ch.1 - ch.16)
 vv = Expression : 00H - 7FH (0 - 127)

- *Expression and Volume messages are cumulative, and the result will control the overall volume. Use Expression messages for expression pedal, or creating expressive effects, such as crescendo, decrescendo, while playing.
- *Ignored when "Rx.Expression = OFF".
- *Ignored when the MINUS ONE function is set to ON and the MIDI channel number of the message from MIDI IN is the same as the selected part.

○ Hold1

Status Second Third
 BnH 40H vvH

n = MIDI channel number : 0H - FH (ch.1 - ch.16)
 vv = Control Value : 00H - 7FH (0 - 127)
 0 - 63 = OFF, 64 - 127 = ON

*Ignored when "Rx.Hold1 = OFF".
 *Ignored when the MINUS ONE function is set to ON and the MIDI channel number of the message from MIDI IN is the same as the selected part.

○ Portamento

Status Second Third
 BnH 41H vvH

n = MIDI channel number : 0H - FH (ch.1 - ch.16)
 vv = Control Value : 00H - 7FH (0 - 127) 0 - 63 = OFF 64 - 127 = ON

*Ignored when "Rx.Portamento = OFF".

○ Sostenuto

Status Second Third
 BnH 42H vvH

n = MIDI channel number : 0H - FH (ch.1 - ch.16)
 vv = Control Value : 00H - 7FH (0 - 127) 0 - 63 = OFF 64 - 127 = ON

*Ignored when "Rx.Sostenuto = OFF".
 *Ignored when the MINUS ONE function is set to ON and the MIDI channel number of the message from MIDI IN is the same as the selected part.

○ Soft

Status Second Third
 BnH 43H vvH

n = MIDI channel number : 0H - FH (ch.1 - ch.16)
 vv = Control Value : 00H - 7FH (0 - 127)

*Ignored when "Rx.Soft = OFF".
 *Ignored when the MINUS ONE function is set to ON and the MIDI channel number of the message from MIDI IN is the same as the selected part.

○ Portamento Control

Status Second Third
 BnH 54H kkH

n = MIDI channel number : 0H - FH (ch.1 - ch.16)
 kk = source note number for pitch reference : 00H - 7FH (0 - 127)

*When a Note On message is received after a Portamento Control message, the voice's pitch will glide from the pitch specified by the source note number of the Portamento Control message at the rate set by the portamento time controller (regardless portamento on/off).
 If there is a currently sounding voice whose note number is coincident with the source note number, the voice's pitch will glide to the new Note On's pitch according to the portamento time without re-triggering (played legato).
 Then no new voice should be assigned.

Example 1.

On MIDI	Description	Result
90 3C 40	Note on C4	C4 on
B0 54 3C	Portamento Control from C4	no change
90 40 40	Note on E4	Re-tuning (glide) from C4 to E4
80 3C 40	Note off C4	no change
80 40 40	Note off E4	E4 off

Example 2.

On MIDI	Description	Result
B0 54 3C	Portamento Control from C4	no change
90 40 40	Note on E4	E4 on with glide from C4
80 40 40	Note off E4	E4 off

○ Effect1 depth (Reverb send level)

Status Second Third
 BnH 5BH vvH

n = MIDI channel number : 0H - FH (ch.1 - ch.16)
 vv = Reverb send level : 00H - 7FH (0 - 127)

*Effect1 depth messages control the Send Level of the specified channel (part) to the internal Reverb unit.

○ Effect3 depth (Chorus send level)

Status Second Third
 BnH 5DH vvH

n = MIDI channel number : 0H - FH (ch.1 - ch.16)
 vv = Chorus send level : 00H - 7FH (0 - 127)

*Effect3 depth messages control the Send Level of the specified channel (part) to the internal Chorus unit.

○ NRPN MSB/LSB

Status Second Third
 BnH 63H mmH
 BnH 62H llH

n = MIDI channel number : 0H - FH (ch.1 - ch.16)
 mm = MSB of the NRPN
 ll = LSB of the NRPN

*Recognized when "Rx.NRPN = ON". "Rx.NRPN" is set to OFF by receiving "Turn General MIDI System On", and it is set to ON by "GS RESET".
 *The values set by NRPN won't reset by receiving new Program Change messages or Reset All Controllers.

** NRPN **
 An NRPN (Non Registered Parameter Number) is an expanded control change message.
 Each function of an NRPN is described by the individual manufacturer.
 To use NRPN, set NRPN number (MSB/LSB) before sending data. Then send data by Data entry message (Control Change # 6/3B). And then, it is recommended to send RPN null (RPN number = 7FH/7FH) to prevent the data from being unexpectedly change. For more explanation, refer to Chapter 4. Useful Information, Example of actual MIDI messages <EXAMPLE 4 >.

You can change the following parameters using an NRPN.

NRPN MSB	NRPN LSB	Data entry MSB	Description
01H	08H	mmH	Vibrato rate relative change on specified channel mm: 0EH - 40H - 72H (-50 - 0 - +50)
01H	09H	mmH	Vibrato depth relative change on specified channel mm: 0EH - 40H - 72H (-50 - 0 - +50)
01H	0AH	mmH	Vibrato delay relative change on specified channel mm: 0EH - 40H - 72H (-50 - 0 - +50)
01H	20H	mmH	TVF cutoff frequency relative change on specified channel mm: 0EH - 40H - 72H (-50 - 0 - +50)
01H	21H	mmH	TVF resonance relative change on specified channel mm: 0EH - 40H - 72H (-50 - 0 - +50)
01H	63H	mmH	TVF & TVA Env. Attack time relative change on specified channel mm: 0EH - 40H - 72H (-50 - 0 - +50)
01H	64H	mmH	TVF & TVA Env. Decay time relative change on specified channel mm: 0EH - 40H - 72H (-50 - 0 - +50)
01H	66H	mmH	TVF & TVA Env. Release time relative change on specified channel mm: 0EH - 40H - 72H (-50 - 0 - +50)
18H	rrH	mmH	Pitch coarse of drum instrument relative change on specified drum instrument rr : key number of drum instrument mm: 00H - 40H - 7FH (-64 - 0 - +63 semitone)
1AH	rrH	mmH	TVA level of drum instrument absolute change on specified drum instrument rr : key number of drum instrument mm: 00H - 7FH (zero - maximum)
1CH	rrH	mmH	Panpot of drum instrument absolute change on specified drum instrument rr : key number of drum instrument mm: 00H, 01H - 40H - 7FH (Random, Left - Center - Right)
1DH	rrH	mmH	Reverb send level of drum instrument absolute change on specified drum instrument rr : key number of drum instrument mm: 00H - 7FH (zero - maximum)
1EH	rrH	mmH	Chorus send level of drum instrument absolute change on specified drum instrument rr : key number of drum instrument mm: 00H - 7FH (zero - maximum)

*Data entry LSB is ignored.
 *The relative change means that the parameter value (e.g. -50 - 0 - +50) will be added to the preset value.
 *The absolute change means that the parameter value will be replaced by the received value.

○ RPN MSB/LSB

Status	Second	Third
BnH	65H	mmH
BnH	64H	llH

n = MIDI channel number : 0H - FH (ch.1 - ch.16)
 mm = MSB of the RPN
 ll = MSB of the RPN

*Ignored when "Rx.RPN = OFF".
 *The values set by an RPN won't be reset by receiving new Program Change messages or Reset All Controllers.

** RPN **

An RPN (Registered Parameter Number) is an expanded control change message. Each function of an RPN is described by the MIDI Standard. To use an RPN, set the RPN number (MSB/LSB) before sending data. Then send data by Data entry message (Control Change # 6/3B). It is then recommended to send RPN null (RPN number = 7FH/7FH) to prevent the data from being unexpectedly change. For more explanation, refer to Chapter 4. Useful Information, Example of actual MIDI messages < EXAMPLE 4 >.

You can change the following parameters using an RPN.

RPN	Data entry	Description
MSB LSB	MSB LSB	
00H 00H	mmH ---	Pitch bend sensitivity mm : 00H - 18H (0 - 24 semitone) ll : ignored (value = 00H) (Up to 2 octaves)
Default value = 02H (two semitones)		
00H 01H	mmH llH	Master fine tuning mm, ll : 00 00H - 40 00H - 7F 7FH (- 8192 x 100/8192 - 0 - + 8191 x 100/8192 cents)
00H 02H	mmH ---	Master coarse tuning mm : 28H - 40H - 58H (- 24 - 0 - + 24 semitones) ll : ignored (value = 00H)
7FH 7FH	--- ---	RPN null Return to disable condition. The parameter already set retains its value. mm, ll : ignored

● Program change

Status	Second
CnH	ppH

n = MIDI channel number : 0H - FH (ch.1 - ch.16)
 pp = Program number : 00H - 7FH (prog.1 - prog.128)

*The voices already ON before receiving a program change message aren't affected. The Tone will be changed by a new Note-on message after the program change is received.
 *Ignored when "Rx.Program change = OFF".
 *In the drum part, Program change messages are ignored when the Bank is set at 129 - 16384 (ie. the value of the control change number 0 is not 00H).
 *Ignored when "Rx.Inst Chg : Off" or USER function (P.28) is On.

● Channel pressure

Status	Second
DnH	vvH

n = MIDI channel number : 0H - FH (ch.1 - ch.16)
 vv = Value : 00H - 7FH (0 - 127)

*Effect to the parameter set on "MOD controller function". The default setting has no effect.
 *Ignored when "Rx.Channel pressure = OFF".
 *Ignored when the MINUS ONE function is set to ON and the MIDI channel number of the message from MIDI IN 1 is the same as the selected part.

● Pitch bend change

Status	Second	Third
EnH	llH	mmH

n = MIDI channel number : 0H - FH (ch.1 - ch.16)
 mm, ll = Value : 00 00H - 40 00H - 7F 7FH
 (- 8192 - 0 - + 8191)

*Effect to the parameter set on "MOD controller function". The default setting is pitch bend.
 *Ignored when "Rx.Pitch bend change = OFF".
 *Ignored when the MINUS ONE function is set to ON and the MIDI channel number of the message from MIDI IN 1 is the same as the selected part.

■ Channel Mode Messages

When the MINUS ONE function is set to ON, the MIDI channel number of the message from MIDI IN 2 is converted to that of the selected part.

● All sounds off

Status	Second	Third
BnH	78H	00H

n = MIDI channel number : 0H - FH (ch.1 - ch.16)

*When "All sounds off" is received, all sounds on a specified channel turn off immediately. However, the state of channel messages does not change. You must not use "All sound off" message for "Note off".
 *Ignored when the MINUS ONE function is set to ON and the MIDI channel number of the message from MIDI IN 1 is the same as the selected part.

● Reset all controllers

Status	Second	Third
BnH	79H	00H

n = MIDI channel number : 0H - FH (ch.1 - ch.16)

*When "reset all controllers" is received, the controller value of a specified channel returns to the default values as follows.

Controller	Default Value
Pitch bend change	± 0 (Center)
Polyphonic key pressure	0 (off)
Channel pressure	0 (off)
Modulation	0 (off)
Expression	127 (maximum)
Hold1	0 (off)
Portamento	0 (off)
Sostenuto	0 (off)
Soft	0 (off)
RPN	disabled. The parameter already set retains its old value.
NRPN	disabled. The parameter already set retains its old value.

*Ignored when the MINUS ONE function is set to ON and the MIDI channel number of the message from MIDI IN 1 is the same as the selected part.

● All notes off

Status	Second	Third
BnH	7BH	00H

n = MIDI channel number : 0H - FH (ch.1 - ch.16)

*When "All notes off" is received, all notes are turned off in the specified channel. However, sound continues while hold1 and/or sostenuto is on.
 *Ignored when the MINUS ONE function is set to ON and the MIDI channel number of the message from MIDI IN 1 is the same as the selected part.

● OMNI OFF

Status	Second	Third
BnH	7CH	00H

n = MIDI channel number : 0H - FH (ch.1 - ch.16)

*OMNI OFF is only recognized as "all notes off"; the Mode doesn't change.

● OMNI ON

Status	Second	Third
BnH	7DH	00H

n = MIDI channel number : 0H - FH (ch.1 - ch.16)

*OMNI ON is only recognized as "all notes off". Mode doesn't change (OMNI OFF remains).

● MONO

Status	Second	Third
BnH	7EH	mmH

n = MIDI channel number : 0H - FH (ch.1 - ch.16)
mm = number of mono : 00H - 10H (0 - 16)

*MONO is recognized as "all sounds off". The specified channel turns to Mode4 (M = 1), even if mm is not equal to 1 (mm is ignored).

● POLY

Status	Second	Third
BnH	7FH	00H

n = MIDI channel number : 0H - FH (ch.1 - ch.16)

*POLY is recognized as "all sounds off". The specified channel turns to Mode3.

■ System Realtime Message

● Active sensing

Status
FEH

*Having received an "active sensing" message, GS expects to receive additional active sensing messages at 300ms intervals. If the interval is greater than 420ms, GS executes "All sounds off", "All notes off" and "Reset all controllers" and returns to normal operation. (Monitoring of active sensing messages will terminate.)

■ System Exclusive Message

Status	Data	Status
F0H	iiH, ddH, ..., eeH	F7H

F0H : System Exclusive
ii = ID number : The ID number identifies the manufacturer of a MIDI device that triggers an Exclusive message. Value 7EH and 7FH are reserved to use as universal messages which are used for extension of the MIDI Standard.
41H : Roland's Manufacturer - ID.
7EH : Universal Non - Realtime Message
7FH : Universal Realtime Message
dd, ..., ee = data : 00H - 7FH (0 - 127)
F7H : EOX (End of Exclusive/System common)

● System Exclusive Messages of Mode Change

System Exclusive Messages of Mode Change are the messages used to initialize the internal parameters of the device to General MIDI mode or GS default mode.

"GS reset" use a form of Roland Exclusive Message. "Turn General MIDI System On" uses a form of Universal Non - real Time Message.

○ GS reset

Status	Data Byte	Status
F0H	41H, 10H, 42H, 12H, 40H, 00H, 7FH, 00H, 41H	F7H

Byte	Description
F0H	Exclusive status
41H	ID number (Roland)
10H	Device ID
42H	Model ID (GS)
12H	Command ID (DT1)
40H	Address MSB
00H	:
7FH	Address LSB
00H	Data (GS reset)
41H	Checksum
F7H	EOX (End of exclusive)

*Upon receiving this message, all the internal parameters are set to the default settings of the GS Format. (Rx.NRPN SW and Rx.Bank sel SW will be turned ON by this message.)

*It takes about 50ms to execute this message.

*Ignored when "Rx.GS Reset : Off" or "Rx.SysEx : Off".

○ Turn General MIDI System On

Status	Data Byte	Status
F0H	7EH, 7FH, 09H, 01H	F7H

Byte	Description
F0H	Exclusive status
7EH	ID number (Universal non - real time message)
7FH	ID of target device (Broadcast)
09H	sub - ID # 1 (General MIDI message)
01H	sub - ID # 2 (General MIDI On)
F7H	EOX (End of exclusive)

*Upon receiving this message, all the internal parameters are set to the default settings of General MIDI System Level 1. (Rx.NRPN SW and Rx.Bank sel SW will be turned OFF by this message.)

*It takes about 50ms to execute this message.

*Ignored when "Rx.GM On : Off" or "Rx.SysEx : Off".

● Universal Realtime System Exclusive Message

○ Master Volume

Status	Data Byte	Status
F0H	7FH, 7FH, 04H, 01H, 01H, mmH	F7H

Byte	Description
F0H	Exclusive status
7FH	ID number (Universal Realtime message)
7FH	ID of target device (Broadcast)
04H	sub - ID # 1 (Device Control Message)
02H	sub - ID # 2 (Master Volume)
mm, ll	Master Volume (00 00H - 7F 7FH (0 - 16383))
F7H	EOX (End of exclusive)

*The LSB (llH) is ignored (value = 0).

*Devices whose "Rx.Sys.Ex.SW = OFF" won't recognize this message.

● Data Transfer

SC - 55mk II can transmit and receive the various parameters using System Exclusive messages of the following data format.

SC - 55mk II have a unique Exclusive communication function which has it's own Model IDs in addition to the GS Common Exclusive messages. GS Common Exclusive messages use Model ID = 42H and Device ID = 17 (10H). SC - 55mk II's Exclusive messages use Model ID = 45H. SC - 55mk II can change the Device ID number.

○ Request data 1 RQ1

This message is sent out to request the remote device to send back the required data. It contains data for the address and size that specify designation and length, respectively. On receiving a proper RQ1 message for the device, the device will transmit a "Data set 1 (DT1)" message, which contains the requested data. Otherwise, the device will not send anything.

Status	Data Byte	Status
F0H	41H, dev, 42H, 11H, aaH, bbH, ccH, ssH, ttH, uuH, sum	F7H
Byte	Description	
F0H	Exclusive status	
41H	Manufacturer's ID	(Roland)
dev	Device ID	(dev: 00H - 1FH (1 - 32) The default value is 10H (17).)
42H	Model ID	(GS), 45H (SC - 55, 155)
11H	Command ID	(RQ1)
aaH	Address MSB	
bbH	:	
ccH	Address LSB	
ssH	Size MSB	
ttH	:	
uuH	Size LSB	
sum	Checksum	
F7H	EOX	(End of exclusive)

*SC-55mk II only recognizes the RQ1 messages whose address and size match the Parameter Address Map (Section 3).
*The error checking process uses a Checksum. Refer to Section 4 to calculate a Checksum.

○ Data set 1 DT1

This message corresponds to the actual data transfer process. On receiving a DT1 message, the device writes the data to internal memory according to the address.

Status	Data Byte	Status
F0H	41H, dev, 42H, 12H, aaH, bbH, ccH, ddH, ... eeH, sum	F7H
Byte	Description	
F0H	Exclusive status	
41H	Manufacturer's ID	(Roland)
dev	Device ID	(dev: 00H - 1FH (1 - 32) The default value is 10H (17).)
42H	Model ID	(GS), 45H (SC - 55, 155)
12H	Command ID	(DT1)
aaH	Address MSB	
bbH	:	
ccH	Address LSB	
ddH	Data	
:	:	
eeH	Data	
sum	Checksum	
F7H	EOX	(End of exclusive)

*SC-55mk II only recognizes the DT1 messages whose address and size match the Parameter Address Map (Section 3).
*To send large DT1 messages at a time, insert 40ms - intervals at least in between each packet.
*The error checking process uses a Checksum. Refer to Section 4 to calculate a Checksum.

2. Transmit data

The Transmit function is a optional specification of the GS Format. This implementation is for the models which have the Transmit function.

■ Channel Voice Message

● Control change

This message is transmitted with the respective MIDI channel number which is assigned to each part.

○ Bank select

Status	Second	Third
BnH	00H	mmH
BnH	20H	llH
n = MIDI channel number	: 0H - FH (ch.1 - ch.16)	
mm, ll = Bank number	: 00H, 00H - 7FH, 7FH (bank1 - bank16384)	

*The "Variation number" of the SC-55mk II is written as the decimal number that is the value of MSB (Control change number 00H) of the Bank select. value of MSB (Control change number 00H) of the Bank select.
*This message is transmitted when "Send GS SETUP" is executed.

○ Volume

Status	Second	Third
BnH	07H	vvH
n = MIDI channel number	: 0H - FH (ch.1 - ch.16)	
vv = Volume	: 00H - 7FH (0 - 127)	

*This message is transmitted when "Send GM/GS SETUP" is executed.

○ Panpot

Status	Second	Third
BnH	0AH	vvH
n = MIDI channel number	: 0H - FH (ch.1 - ch.16)	
vv = Panpot	: 00H - 40H - 7FH (Left - Center - Right)	

*Resolution of panpot is approx. 7-bit (127 steps).
*This message is transmitted when "Send GM/GS SETUP" is executed.

○ Effect1 depth(Reverb send level)

Status	Second	Third
BnH	5BH	vvH
n = MIDI channel number	: 0H - FH (ch.1 - ch.16)	
vv = Reverb send depth	: 00H - 7FH (0 - 127)	

*This message is transmitted when "Send GM/GS SETUP" is executed.

○ Effect3 depth(Chorus send level)

Status	Second	Third
BnH	5DH	vvH
n = MIDI channel number	: 0H - FH (ch.1 - ch.16)	
vv = Chorus send depth	: 00H - 7FH (0 - 127)	

*This message is transmitted when "Send GM/GS SETUP" is executed.

○ Program change

Status	Second	Third
CnH	ppH	
n = MIDI channel number	: 0H - FH (ch.1 - ch.16)	
pp = Program number	: 00H - 7FH (prog.1 - prog.128)	

*This message is transmitted when "Send GM/GS SETUP" is executed.

■ System Realtime Message

● Active sensing

Status
FEH

*Transmits at about 250ms intervals.

■ System Exclusive Message

● System Exclusive Messages of Mode Change

System Exclusive Messages of Mode Change are the messages used to initialize the internal parameters of the device to General MIDI mode or GS default mode. "GS reset" uses a form of Roland Exclusive Message. "Turn General MIDI System On" use a form of Universal Non-real Time Message.

○ Turn General MIDI System On

Status	Data Byte	Status
FOH	7EH, 7FH, 09H, 01H	F7H
Byte	Description	
FOH	Exclusive status	
7EH	ID number (Universal non - real time message)	
7FH	ID of target device (Broadcast)	
09H	sub - ID # 1 (General MIDI message)	
01H	sub - ID # 2 (General MIDI On)	
F7H	EOX (End of exclusive)	

*Upon receiving this message, all the internal parameters are set to the default settings of General MIDI System Level 1. (Rx.NRPN SW and Rx.Bank sel SW will be turned OFF by this message.)
 *It takes about 50ms to execute this message.
 *This message is transmitted when "Send GM SETUP" is executed.

○ GS reset

Status	Data Byte	Status
FOH	41H, 10H, 42H, 12H, 40H, 00H, 7FH, 00H, 41H	F7H
Byte	Description	
FOH	Exclusive status	
41H	ID number (Roland)	
10H	Device ID	
42H	Model ID (GS)	
12H	Command ID (DT1)	
40H	Address MSB	
00H	:	
7FH	Address LSB	
00H	Data (GS reset)	
41H	Checksum	
F7H	EOX (End of exclusive)	

*This message is transmitted when "Send GS SETUP" is executed.

● Universal Realtime System Exclusive Message

○ Master Volume

Status	Data Byte	Status
FOH	7FH, 7FH, 04H, 01H, 0H, mmH	F7H
Byte	Description	
FOH	Exclusive status	
7FH	ID number (Universal Realtime message)	
7FH	ID of target device (Broadcast)	
04H	sub - ID # 1 (Device Control Message)	
02H	sub - ID # 2 (Master Volume)	
mmH	Master Volume 00 00H - 7F 7FH (0 - 16383)	
F7H	EOX (End of exclusive)	

*This message is transmitted when "Send GM SETUP" is executed.
 *This message is transmitted when "Use Univ Rt" is On and "Send GS SETUP" is executed.

● Data Transfer

SC - 55mk II transmits "Data set 1 (DT1)" message when receiving a proper "Request Data 1 (RQ1)" message. Refer to section 1 (System Exclusive Message)

○ Data set 1 DT1 (12H)

Status	Data Byte	Status
FOH	41H, dev, 42H, 12H, aaH, bbH, ccH, ddH, ... eeH, sum	F7H
Byte	Description	
FOH	Exclusive status	
41H	Manufacturer's ID (Roland)	
dev	Device ID (dev : 00H - 1FH (1 - 32) The default value is 10H (17).)	
42H	Model ID (GS), 45H (SC - 55, 155)	
12H	Command ID (DT1)	
aaH	Address MSB	
bbH	Address	
ccH	Address LSB	
ddH	Data	
:	:	
eeH	Data	
sum	Checksum	
F7H	EOX (End of exclusive)	

*SC - 55mk II only sends the DT1 messages whose address and size match the Parameter Address Map (Section 3).
 *If the amount of data to send is large (more than 128 bytes), then the data will be sent out in separate packets.
 *Refer to Section 4 to calculate a Checksum (P.103).

3. Parameter address map (Model ID=42H or 45H)

This map indicates address, size, Data (range), Parameter, Description, and Default Value of parameters which can be transferred using "Request data 1 (RQ1)" and "Data set 1 (DT1)".
 All the numbers of address, size, Data, and Default Value are indicated in 7 - bit Hexadecimal - form.

■ Address Block map

An outlined address map of the Exclusive Communication is shown below :

<Model ID = 45H>

Address (H)	Block	Sub Block	Notes
10 00 00	+-----+ Display data +-----+		Individual (DT1 only)
10 10 00	+-----+ Function Control Parameter +-----+		Individual (DT1 only)

<Model ID = 42H>

Address (H)	Block	Sub Block	Notes
40 00 00	+-----+ System parameters +-----+		Individual
40 01 00	+-----+ Patch parameters +-----+ +-----+ Patch common +-----+ +-----+ Patch block 0 +-----+ +-----+ +-----+ Patch block F +-----+	Individual
41 00 00	+-----+ Drum setup parameters +-----+ +-----+ Drum map name +-----+ +-----+ Drum inst parameters +-----+	Individual
48 00 00	+-----+ Bulk dump +-----+ +-----+ System parameters +-----+ +-----+ Patch common +-----+ +-----+ Patch block 0 +-----+ +-----+ +-----+ Patch block F +-----+	Bulk
49 00 00	+-----+ Bulk dump (Drum setup parameters) +-----+ +-----+ Drum inst parameters +-----+ +-----+ Drum map name +-----+	Bulk

There are two types of GS Exclusive message. One is an individual parameter communication, the other is a bulk dump communication.

■ Individual parameter

You can use individual parameter communication to send or request an individual parameter value.
 One packet of System Exclusive messages "F0 F7" can only have one parameter (which may contain several bytes).
 You cannot use any address having "*" for the top address in a System Exclusive message.

<MODEL ID = 45H>

● Display Data

Address(H)	SIZE(H)	Data(H)	Parameter	Description	Default Value (H)
10 00 00	00 00 20	20 - 7F	DISPLAYED LETTER	32 - 127 (ASCII)	--
10 00 01 #					
10 00 02 #					
10 00 :					
10 00 1F #					

*When this message is received, the string of characters which is based on the received data is displayed for a few seconds.
 Data size is recognized through 1 - 32 bytes. When data size is more than 17 bytes, the display scrolls automatically.

Address(H)	SIZE(H)	Data(H)	Parameter	Description	Default Value (H)
10 01 00	00 00 40	00 - 1F	DISPLAYED DOT DATA	d00 00 - 31	--
10 01 01 #				d01	
10 01 02 #				d02	
10 01 :				:	
10 01 3F #				d63	

*When this message is received, the image of 16 x 16 dots which is based on the received data is displayed for a few seconds.
 The relation of data and dot is as follows:

bit	4	3	2	1	0	4	3	2	1	0	4	3	2	1	0	4
[***	***	d00	***	***]	[***	***	d16	***	***]	[***	***	d32	***	***]	[d48]	
[***	***	d01	***	***]	[***	***	d17	***	***]	[***	***	d33	***	***]	[d49]	
[***	***	d02	***	***]	[***	***	d18	***	***]	[***	***	d34	***	***]	[d50]	
[***	***	d03	***	***]	[***	***	d19	***	***]	[***	***	d35	***	***]	[d51]	
[***	***	d04	***	***]	[***	***	d20	***	***]	[***	***	d36	***	***]	[d52]	
[***	***	d05	***	***]	[***	***	d21	***	***]	[***	***	d37	***	***]	[d53]	
[***	***	d06	***	***]	[***	***	d22	***	***]	[***	***	d38	***	***]	[d54]	
[***	***	d07	***	***]	[***	***	d23	***	***]	[***	***	d39	***	***]	[d55]	
[***	***	d08	***	***]	[***	***	d24	***	***]	[***	***	d40	***	***]	[d56]	
[***	***	d09	***	***]	[***	***	d25	***	***]	[***	***	d41	***	***]	[d57]	
[***	***	d10	***	***]	[***	***	d26	***	***]	[***	***	d42	***	***]	[d58]	
[***	***	d11	***	***]	[***	***	d27	***	***]	[***	***	d43	***	***]	[d59]	
[***	***	d12	***	***]	[***	***	d28	***	***]	[***	***	d44	***	***]	[d60]	
[***	***	d13	***	***]	[***	***	d29	***	***]	[***	***	d45	***	***]	[d61]	
[***	***	d14	***	***]	[***	***	d30	***	***]	[***	***	d46	***	***]	[d62]	
[***	***	d15	***	***]	[***	***	d31	***	***]	[***	***	d47	***	***]	[d63]	
	1	2	3	4	5	6	7	8	9	10	11	12	13	14	15	16

*The bit4 - 0 (lower 5 bit) in the data byte are the displayed dots except that bit4 is the displayed dot in d48 - d63.

```
d00: 0--*****
d01: 0--*****
|
d47: 0--*****
d48: 0--*-----
|
d63: 0--*-----
```

*: When the value of bit is 0, the dot is turned off.
 When the value of bit is 1, the dot is turned on.
 -: don't care

● Display Mode

Address(H)	SIZE(H)	Data(H)	Parameter	Description	Default Value (H)	Description
10 08 00	00 00 01	00 - 07	Display type	Type 1 - 8	00	Type 1
10 08 01	00 00 01	00 - 03	Peak Hold Type	Off / 1 - 3	01	1
10 08 10	00 00 01	00 - 06	Displayed Parameter	00: Standard 01: LEVEL 02: PAN 03: REVERB 04: CHORUS 05: K.SHIFT 06: MIDI CH	00	Standard

● Function Control Parameter

To send or request a Function Control Parameter, don't use the part number (which is usually same as the MIDI channel number) but the BLOCK NUMBER in the message.

```
* x...BLOCK NUMBER (0 - F),  Part 1 (default MIDIch = 1) x = 1
                             Part 2 (default MIDIch = 2) x = 2
                             :
                             :
                             Part 9 (default MIDIch = 9) x = 9
                             Part10 (default MIDIch = 10) x = 0
                             Part11 (default MIDIch = 11) x = A
                             Part12 (default MIDIch = 12) x = B
                             :
                             :
                             Part16 (default MIDIch = 16) x = F
```

Address (H)	Size (H)	Data (H)	Parameter	Description	Default Value (H)	Description
10 10 00	00 00 01	00 - 10	Select BLOCK (Part Select)	00 : PART10 01 : PART 1 02 : PART 2 . . 0F : PART16 10 : ALL	01	PART1
10 10 01	00 00 01	00 - 01	Minus One	Off / On	00	Off
10 10 02	00 00 01	00 - 01	Solo (Part Monitor)	Off / On	00	Off
10 11 00	00 00 01	00 - 01	ALL Mute	Off / On	00	Off
10 11 1x	00 00 01	00 - 01	Block x Mute (Part Mute)	Off / On	00	Off

*These messages are received when Function Control switch is set to On.

<MODEL ID = 42H>

● System Parameters

Parameters related to the system of the device are called "System" Parameters.

Address (H)	Size (H)	Data (H)	Parameter	Description	Default Value (H)	Description
40 00 00	00 00 04	0018 - 07E8	MASTER TUNE	- 100.0 - + 100.0 [cent] Use nibblized data.	00 04 00 00	0 [cent]
40 00 01 #						
40 00 02 #						
40 00 03 #						
40 00 04	00 00 01	00 - 7F	MASTER VOLUME	0 - 127 (= F0 7F 7F 04 01 00 vv F7)	7F	127
40 00 05	00 00 01	28 - 58	MASTER KEY - SHIFT	- 24 - + 24 [semitones]	40	0 [semitones]
40 00 06	00 00 01	01 - 7F	MASTER PAN		40	center
40 00 7F	00 00 01	00, 7F	MODE SET	00 = GS Reset (Rx. only)		

Refer to "System Exclusive Messages of Mode Change" (Page 93)

For example : If you set + 100.0 cents for master tune, you must send the message as follows.
F0 41 10 42 12 40 00 00 00 07 0E 08 23 F7

If you set 100 (decimal) for master volume, you must send the message as follows.
F0 41 10 42 12 40 00 04 64 58 F7

● Patch Parameters

SC - 55mk II has 16 parts. The parameters of each part are called PATCH PARAMETERS.

To send or request a PATCH PARAMETER, don't use the part number (which is usually same as the MIDI channel number) but the BLOCK NUMBER in the message.

```
*x...BLOCK NUMBER (0 - F),      Part 1 (default MIDIch = 1)  x = 1
                                Part 2 (default MIDIch = 2)  x = 2
                                :
                                :
                                Part 9 (default MIDIch = 9)  x = 9
                                Part10 (default MIDIch = 10) x = 0
                                Part11 (default MIDIch = 11) x = A
                                Part12 (default MIDIch = 12) x = B
                                :
                                :
                                Part16 (default MIDIch = 16) x = F
```

*n...MIDI channel number (0 - F) of the BLOCK.

Address (H)	Size (H)	Data (H)	Parameter	Description	Default Value (H)	Description
40 01 00	00 00 10	20 - 7F	PATCH NAME	16 ASCII Characters		
40 01 : #						
40 01 0F #						
40 01 10	00 00 10	00 - 1C	VOICE RESERVE	Part 10 (Drum part)	02	2
40 01 11 #				Part 1	06	6
40 01 12 #				Part 2	02	2
40 01 13 #				Part 3	02	2
40 01 14 #				Part 4	02	2
40 01 15 #				Part 5	02	2
40 01 16 #				Part 6	02	2
40 01 17 #				Part 7	02	2
40 01 18 #				Part 8	02	2
40 01 19 #				Part 9	02	2
40 01 1A #				Part 11	00	0
40 01 1B #				Part 12	00	0
40 01 1C #				Part 13	00	0
40 01 : #				:		
40 01 1F #				Part 16	00	0

*The sum total of voices in the voice reserve function must be equal to or less than the number of the maximum polyphony. The maximum polyphony of SC - 55mk II is 28.

*For compatibility with other GS models, it is recommended that the maximum polyphony be equal to or less than 24.

40 01 30	00 00 01	00 - 07	REVERB MACRO	00 : Room 1 01 : Room 2 02 : Room 3 03 : Hall 1 04 : Hall 2 05 : Plate 06 : Delay 07 : Panning Delay	04	Hall 2
40 01 31	00 00 01	00 - 07	REVERB CHARACTER 0 - 7		04	4
40 01 32	00 00 01	00 - 07	REVERB PRE - LPF 0 - 7		00	0
40 01 33	00 00 01	00 - 7F	REVERB LEVEL 0 - 127		40	64
40 01 34	00 00 01	00 - 7F	REVERB TIME 0 - 127		40	64
40 01 35	00 00 01	00 - 7F	REVERB DELAY FEEDBACK 0 - 127		00	0
40 01 36	00 00 01	00 - 7F	REVERB SEND LEVEL TO CHORUS 0 - 127		00	0

*REVERB MACRO is a parameter used to select the preset type of the effect.

*When set to another REVERB MACRO, all other reverb parameters will be reset to the values set for each type of REVERB MACRO.

40 01 38	00 00 01	00 - 07	CHORUS MACRO	00 : Chorus 1 01 : Chorus 2 02 : Chorus 3 03 : Chorus 4 04 : Feedback Chorus 05 : Flanger 06 : Short Delay 07 : Short Delay (FB)	02	Chorus 3
40 01 39	00 00 01	00 - 07	CHORUS PRE - LPF 0 - 7		00	0
40 01 3A	00 00 01	00 - 7F	CHORUS LEVEL 0 - 127		40	64
40 01 3B	00 00 01	00 - 7F	CHORUS FEEDBACK 0 - 127		08	8
40 01 3C	00 00 01	00 - 7F	CHORUS DELAY 0 - 127		50	80
40 01 3D	00 00 01	00 - 7F	CHORUS RATE 0 - 127		03	3
40 01 3E	00 00 01	00 - 7F	CHORUS DEPTH 0 - 127		13	19
40 01 3F	00 00 01	00 - 7F	CHORUS SEND LEVEL TO REVERB 0 - 127		00	0

*CHORUS MACRO is a parameter used to select the preset type of effect.

*When set to another CHORUS MACRO, then all other chorus parameters will be reset to the values set for each type of CHORUS MACRO.

Address (H)	Size (H)	Data (H)	Parameter	Description	Default Value (H)	Description
40 1x 00	00 00 02	00 - 7F	TONE NUMBER	CC #00 VALUE (0 - 127)	00	0
40 1x 01 #		00 - 7F		P.C. VALUE (1 - 128)	00	1
*Ignored when "Rx.Inst Chg : Off" or USER function (P.28) is ON.						
40 1x 02	00 00 01	00 - 10	Rx. CHANNEL	1 - 16, OFF		same as the Part Number
40 1x 03	00 00 01	00 - 01	Rx. PITCH BEND	OFF / ON	01	ON
40 1x 04	00 00 01	00 - 01	Rx. CH PRESSURE (CA)	OFF / ON	01	ON
40 1x 05	00 00 01	00 - 01	Rx. PROGRAM CHANGE	OFF / ON	01	ON
40 1x 06	00 00 01	00 - 01	Rx. CONTROL CHANGE	OFF / ON	01	ON
40 1x 07	00 00 01	00 - 01	Rx. POLY PRESSURE (PA)	OFF / ON	01	ON
40 1x 08	00 00 01	00 - 01	Rx. NOTE MESSAGE	OFF / ON	01	ON
*Ignored when "MUTE Lock : On"						
40 1x 09	00 00 01	00 - 01	Rx. RPN	OFF / ON	01	ON
40 1x 0A	00 00 01	00 - 01	Rx. NRPN	OFF / ON	00 (01 *)	OFF (ON *)
*Rx. NRPN is set to OFF by "Turn General MIDI system On", and it is set to ON by "GS RESET" .						
40 1x 0B	00 00 01	00 - 01	Rx. MODULATION	OFF / ON	01	ON
40 1x 0C	00 00 01	00 - 01	Rx. VOLUME	OFF / ON	01	ON
40 1x 0D	00 00 01	00 - 01	Rx. PANPOT	OFF / ON	01	ON
40 1x 0E	00 00 01	00 - 01	Rx. EXPRESSION	OFF / ON	01	ON
40 1x 0F	00 00 01	00 - 01	Rx. HOLD1	OFF / ON	01	ON
40 1x 10	00 00 01	00 - 01	Rx. PORTAMENTO	OFF / ON	01	ON
40 1x 11	00 00 01	00 - 01	Rx. SOSTENUTO	OFF / ON	01	ON
40 1x 12	00 00 01	00 - 01	Rx. SOFT	OFF / ON	01	ON
*The OFF/ON setting of the receiving switch (40 1n 03 - 40 1n 12) must be executed while the unit is not sounding.						
40 1x 13	00 00 01	00 - 01	MONO/POLY MODE	Mono / Poly (= Bn 7E 01 / Bn 7F 00)	01	Poly
40 1x 14	00 00 01	00 - 02	ASSIGN MODE	0 = SINGLE 1 = LIMITED - MULTI 2 = FULL - MULTI	00 at x = 0 01 at x ≠ 0	SINGLE LIMITED - MULTI
*ASSIGN MODE is a parameter used to select the voice assign manner when "multiple Note Ons" occur (the same note number on the same channel at the same time).						
*The best assign modes (SINGLE (0) for the Drum part and LIMITED - MULTI (1) for the other parts) are selected automatically, so you need not reset this parameter.						
40 1x 15	00 00 01	00 - 02	USE FOR RHYTHM PART	0 = OFF 1 = MAP1 2 = MAP2	00 at x ≠ 0 01 at x = 0	OFF MAP1
*USE FOR RHYTHM PART is a parameter to define the part to be used as a normal part (0), as a drum part using DRUM MAP1 (1), or a drum part using DRUM MAP2 (2). The default is MAP1 (1) for Part10 (MIDI CH = 10, x = 0), and all other parts are set to normal parts (OFF (0)).						
40 1x 16	00 00 01	28 - 5B	PITCH KEY SHIFT	- 24 - + 24 [semitones]	40	0 [semitone]
40 1x 17	00 00 02	08 - FB	PITCH OFFSET FINE	- 12.0 - + 12.0 [Hz]	08 00	0 [Hz]
40 1x 18 #				Use nibblized data.		
40 1x 19	00 00 01	00 - 7F	PART LEVEL	0 - 127 (= Bn 07 vv)	64	100
*Ignored when USER function (P.28) is ON.						
40 1x 1A	00 00 01	00 - 7F	VELOCITY SENSE DEPTH	0 - 127	40	64
40 1x 1B	00 00 01	00 - 7F	VELOCITY SENSE OFFSET	0 - 127	40	64
40 1x 1C	00 00 01	00 - 7F	PART PANPOT	- 64 (Random), - 63 (LEFT) - + 63 (RIGHT) (= Bn 0A vv, except random)	40	0 (center)
*Ignored when USER function (P.28) is ON.						
40 1x 1D	00 00 01	00 - 7F	KEY RANGE LOW	C - 1 - G9	00	C - 1
40 1x 1E	00 00 01	00 - 7F	KEY RANGE HIGH	C - 1 - G9	7F	G9
40 1x 1F	00 00 01	00 - 5F	CC1 CONTROLLER NUMBER	0 - 95	10	16
40 1x 20	00 00 01	00 - 5F	CC2 CONTROLLER NUMBER	0 - 95	11	17
40 1x 21	00 00 01	00 - 7F	CHORUS SEND LEVEL	0 - 127 (= Bn 5D vv)	00	0
40 1x 22	00 00 01	00 - 7F	REVERB SEND LEVEL	0 - 127 (= Bn 5B vv)	28	40
40 1x 23	00 00 01	00 - 01	Rx.BANK SELECT	OFF / ON	01 (00 *)	ON (OFF *)
*Ignored when USER function (P.28) is ON.						
*Rx. BANK SELECT is set to ON by "GS RESET", and set to OFF by "Turn General MIDI System On".						

Address (H)	Size (H)	Data (H)	Parameter	Description	Default Value (H)	Description
40 1x 30	00 00 01	0E - 72	TONE MODIFY 1	- 50 - + 50	40	0
			Vibrato rate	(= Bn 63 01 62 08 06 vv)		
40 1x 31	00 00 01	0E - 72	TONE MODIFY 2	- 50 - + 50	40	0
			Vibrato depth	(= Bn 63 01 62 09 06 vv)		
40 1x 32	00 00 01	0E - 72	TONE MODIFY 3	- 50 - + 50	40	0
			TVF cutoff freq.	(= Bn 63 01 62 20 06 vv)		
40 1x 33	00 00 01	0E - 72	TONE MODIFY 4	- 50 - + 50	40	0
			TVF resonance	(= Bn 63 01 62 21 06 vv)		
40 1x 34	00 00 01	0E - 72	TONE MODIFY 5	- 50 - + 50	40	0
			TVF & TVA Env.attack	(= Bn 63 01 62 63 06 vv)		
40 1x 35	00 00 01	0E - 72	TONE MODIFY 6	- 50 - + 50	40	0
			TVF & TVA Env.decay	(= Bn 63 01 62 64 06 vv)		
40 1x 36	00 00 01	0E - 72	TONE MODIFY 7	- 50 - + 50	40	0
			TVF & TVA Env.release	(= Bn 63 01 62 66 06 vv)		
40 1x 37	00 00 01	0E - 72	TONE MODIFY 8	- 50 - + 50	40	0
			Vibrato delay	(= Bn 63 01 62 0A 06 vv)		
40 1x 40	00 00 0C	00 - 7F	SCALE TUNING C	- 64 - + 63 [cent]	40	0 [cent]
40 1x 41 #	00 - 7F	00 - 7F	SCALE TUNING C #	- 64 - + 63 [cent]	40	0 [cent]
40 1x 42 #	00 - 7F	00 - 7F	SCALE TUNING D	- 64 - + 63 [cent]	40	0 [cent]
40 1x 43 #	00 - 7F	00 - 7F	SCALE TUNING D #	- 64 - + 63 [cent]	40	0 [cent]
40 1x 44 #	00 - 7F	00 - 7F	SCALE TUNING E	- 64 - + 63 [cent]	40	0 [cent]
40 1x 45 #	00 - 7F	00 - 7F	SCALE TUNING F	- 64 - + 63 [cent]	40	0 [cent]
40 1x 46 #	00 - 7F	00 - 7F	SCALE TUNING F #	- 64 - + 63 [cent]	40	0 [cent]
40 1x 47 #	00 - 7F	00 - 7F	SCALE TUNING G	- 64 - + 63 [cent]	40	0 [cent]
40 1x 48 #	00 - 7F	00 - 7F	SCALE TUNING G #	- 64 - + 63 [cent]	40	0 [cent]
40 1x 49 #	00 - 7F	00 - 7F	SCALE TUNING A	- 64 - + 63 [cent]	40	0 [cent]
40 1x 4A #	00 - 7F	00 - 7F	SCALE TUNING A #	- 64 - + 63 [cent]	40	0 [cent]
40 1x 4B #	00 - 7F	00 - 7F	SCALE TUNING B	- 64 - + 63 [cent]	40	0 [cent]

*SCALE TUNING enables you to slightly raise or lower each note in the same octave range. This setting can be enabled for all pitches of the same note name. 0 cent (40H) is equivalent to "Equal Tempelament".

40 2x 00	00 00 01	28 - 58	MOD PITCH CONTROL	- 24 - + 24 [semitones]	40	0 [semitones]
40 2x 01	00 00 01	00 - 7F	MOD TVF CUTOFF CONTROL	- 9600 - + 9600 [cent]	40	0 [cent]
40 2x 02	00 00 01	00 - 7F	MOD AMPLITUDE CONTROL	- 100.0 - + 100.0 [%]	40	0 [%]
40 2x 03	00 00 01	00 - 7F	MOD LFO1 RATE CONTROL	- 10.0 - + 10.0 [Hz]	40	0 [Hz]
40 2x 04	00 00 01	00 - 7F	MOD LFO1 PITCH DEPTH	0 - 600 [cent]	0A	47 [cent]
40 2x 05	00 00 01	00 - 7F	MOD LFO1 TVF DEPTH	0 - 2400 [cent]	00	0 [cent]
40 2x 06	00 00 01	00 - 7F	MOD LFO1 TVA DEPTH	0 - 100.0 [%]	00	0 [%]
40 2x 07	00 00 01	00 - 7F	MOD LFO2 RATE CONTROL	- 10.0 - + 10.0 [Hz]	40	0 [Hz]
40 2x 08	00 00 01	00 - 7F	MOD LFO2 PITCH DEPTH	0 - 600 [cent]	00	0 [cent]
40 2x 09	00 00 01	00 - 7F	MOD LFO2 TVF DEPTH	0 - 2400 [cent]	00	0 [cent]
40 2x 0A	00 00 01	00 - 7F	MOD LFO2 TVA DEPTH	0 - 100.0 [%]	00	0 [%]
40 2x 10	00 00 01	40 - 58	BEND PITCH CONTROL	0 - 24 [semitone]	42	2 [semitones]
40 2x 11	00 00 01	00 - 7F	BEND TVF CUTOFF CONTROL	- 9600 - + 9600 [cent]	40	0 [cent]
40 2x 12	00 00 01	00 - 7F	BEND AMPLITUDE CONTROL	- 100.0 - + 100.0 [%]	40	0 [%]
40 2x 13	00 00 01	00 - 7F	BEND LFO1 RATE CONTROL	- 10.0 - + 10.0 [Hz]	40	0 [Hz]
40 2x 14	00 00 01	00 - 7F	BEND LFO1 PITCH DEPTH	0 - 600 [cent]	00	0 [cent]
40 2x 15	00 00 01	00 - 7F	BEND LFO1 TVF DEPTH	0 - 2400 [cent]	00	0 [cent]
40 2x 16	00 00 01	00 - 7F	BEND LFO1 TVA DEPTH	0 - 100.0 [%]	00	0 [%]
40 2x 17	00 00 01	00 - 7F	BEND LFO2 RATE CONTROL	- 10.0 - + 10.0 [Hz]	40	0 [Hz]
40 2x 18	00 00 01	00 - 7F	BEND LFO2 PITCH DEPTH	0 - 600 [cent]	00	0 [cent]
40 2x 19	00 00 01	00 - 7F	BEND LFO2 TVF DEPTH	0 - 2400 [cent]	00	0 [cent]
40 2x 1A	00 00 01	00 - 7F	BEND LFO2 TVA DEPTH	0 - 100.0 [%]	00	0 [%]
40 2x 20	00 00 01	28 - 58	CAf PITCH CONTROL	- 24 - + 24 [semitone]	40	0 [semitones]
40 2x 21	00 00 01	00 - 7F	CAf TVF CUTOFF CONTROL	- 9600 - + 9600 [cent]	40	0 [cent]
40 2x 22	00 00 01	00 - 7F	CAf AMPLITUDE CONTROL	- 100.0 - + 100.0 [%]	40	0 [%]
40 2x 23	00 00 01	00 - 7F	CAf LFO1 RATE CONTROL	- 10.0 - + 10.0 [Hz]	40	0 [Hz]
40 2x 24	00 00 01	00 - 7F	CAf LFO1 PITCH DEPTH	0 - 600 [cent]	00	0 [cent]
40 2x 25	00 00 01	00 - 7F	CAf LFO1 TVF DEPTH	0 - 2400 [cent]	00	0 [cent]
40 2x 26	00 00 01	00 - 7F	CAf LFO1 TVA DEPTH	0 - 100.0 [%]	00	0 [%]
40 2x 27	00 00 01	00 - 7F	CAf LFO2 RATE CONTROL	- 10.0 - + 10.0 [Hz]	40	0 [Hz]
40 2x 28	00 00 01	00 - 7F	CAf LFO2 PITCH DEPTH	0 - 600 [cent]	00	0 [cent]
40 2x 29	00 00 01	00 - 7F	CAf LFO2 TVF DEPTH	0 - 2400 [cent]	00	0 [cent]
40 2x 2A	00 00 01	00 - 7F	CAf LFO2 TVA DEPTH	0 - 100.0 [%]	00	0 [%]
40 2x 30	00 00 01	28 - 58	PAf PITCH CONTROL	- 24 - + 24 [semitone]	40	0 [semitones]
40 2x 31	00 00 01	00 - 7F	PAf TVF CUTOFF CONTROL	- 9600 - + 9600 [cent]	40	0 [cent]
40 2x 32	00 00 01	00 - 7F	PAf AMPLITUDE CONTROL	- 100.0 - + 100.0 [%]	40	0 [%]
40 2x 33	00 00 01	00 - 7F	PAf LFO1 RATE CONTROL	- 10.0 - + 10.0 [Hz]	40	0 [Hz]
40 2x 34	00 00 01	00 - 7F	PAf LFO1 PITCH DEPTH	0 - 600 [cent]	00	0 [cent]
40 2x 35	00 00 01	00 - 7F	PAf LFO1 TVF DEPTH	0 - 2400 [cent]	00	0 [cent]
40 2x 36	00 00 01	00 - 7F	PAf LFO1 TVA DEPTH	0 - 100.0 [%]	00	0 [%]
40 2x 37	00 00 01	00 - 7F	PAf LFO2 RATE CONTROL	- 10.0 - + 10.0 [Hz]	40	0 [Hz]
40 2x 38	00 00 01	00 - 7F	PAf LFO2 PITCH DEPTH	0 - 600 [cent]	00	0 [cent]
40 2x 39	00 00 01	00 - 7F	PAf LFO2 TVF DEPTH	0 - 2400 [cent]	00	0 [cent]
40 2x 3A	00 00 01	00 - 7F	PAf LFO2 TVA DEPTH	0 - 100.0 [%]	00	0 [%]

Address (H)	Size (H)	Data (H)	Parameter	Description	Default Value (H)	Description
40 2x 40	00 00 01	28 - 58	CC1 PITCH CONTROL	- 24 - + 24 [semitone]	40	0 [semitones]
40 2x 41	00 00 01	00 - 7F	CC1 TVF CUTOFF CONTROL	- 9600 - + 9600 [cent]	40	0 [cent]
40 2x 42	00 00 01	00 - 7F	CC1 AMPLITUDE CONTROL	- 100.0 - + 100.0 [%]	40	0 [%]
40 2x 43	00 00 01	00 - 7F	CC1 LFO1 RATE CONTROL	- 10.0 - + 10.0 [Hz]	40	0 [Hz]
40 2x 44	00 00 01	00 - 7F	CC1 LFO1 PITCH DEPTH	0 - 600 [cent]	00	0 [cent]
40 2x 45	00 00 01	00 - 7F	CC1 LFO1 TVF DEPTH	0 - 2400 [cent]	00	0 [cent]
40 2x 46	00 00 01	00 - 7F	CC1 LFO1 TVA DEPTH	0 - 100.0 [%]	00	0 [%]
40 2x 47	00 00 01	00 - 7F	CC1 LFO2 RATE CONTROL	- 10.0 - + 10.0 [Hz]	40	0 [Hz]
40 2x 48	00 00 01	00 - 7F	CC1 LFO2 PITCH DEPTH	0 - 600 [cent]	00	0 [cent]
40 2x 49	00 00 01	00 - 7F	CC1 LFO2 TVF DEPTH	0 - 2400 [cent]	00	0 [cent]
40 2x 4A	00 00 01	00 - 7F	CC1 LFO2 TVA DEPTH	0 - 100.0 [%]	00	0 [%]
40 2x 50	00 00 01	28 - 58	CC2 PITCH CONTROL	- 24 - + 24 [semitone]	40	0 [semitones]
40 2x 51	00 00 01	00 - 7F	CC2 TVF CUTOFF CONTROL	- 9600 - + 9600 [cent]	40	0 [cent]
40 2x 52	00 00 01	00 - 7F	CC2 AMPLITUDE CONTROL	- 100.0 - + 100.0 [%]	40	0 [%]
40 2x 53	00 00 01	00 - 7F	CC2 LFO1 RATE CONTROL	- 10.0 - + 10.0 [Hz]	40	0 [Hz]
40 2x 54	00 00 01	00 - 7F	CC2 LFO1 PITCH DEPTH	0 - 600 [cent]	00	0 [cent]
40 2x 55	00 00 01	00 - 7F	CC2 LFO1 TVF DEPTH	0 - 2400 [cent]	00	0 [cent]
40 2x 56	00 00 01	00 - 7F	CC2 LFO1 TVA DEPTH	0 - 100.0 [%]	00	0 [%]
40 2x 57	00 00 01	00 - 7F	CC2 LFO2 RATE CONTROL	- 10.0 - + 10.0 [Hz]	40	0 [Hz]
40 2x 58	00 00 01	00 - 7F	CC2 LFO2 PITCH DEPTH	0 - 600 [cent]	00	0 [cent]
40 2x 59	00 00 01	00 - 7F	CC2 LFO2 TVF DEPTH	0 - 2400 [cent]	00	0 [cent]
40 2x 5A	00 00 01	00 - 7F	CC2 LFO2 TVA DEPTH	0 - 100.0 [%]	00	0 [%]

*As the LFO is used for creating the internal sounds. In some cases, changing the parameters of LFO1 and LFO2 may not affect the sound.

● DRUM SETUP PARAMETERS

*m : Map number (0 = MAP1, 1 = MAP2)

*rr : drum part note number (00H - 7FH)

Address (H)	Size (H)	Data (H)	Parameter	Description
41 m0 00	00 00 0C	20 - 7F	DRUM MAP NAME	ASCII Character
41 m0 0B#				#
41 m1 rr	00 00 01	00 - 7F	PLAY NOTE NUMBER	Pitch coarse
41 m2 rr	00 00 01	00 - 7F	LEVEL	TVA level (= Bn 63 1A 62 rr 06 vv)
41 m3 rr	00 00 01	00 - 7F	ASSIGN GROUP NUMBER	Non, 1 - 127
41 m4 rr	00 00 01	00 - 7F	PANPOT	Random, - 63 (LEFT) - + 63 (RIGHT) (= Bn 63 1C 62 rr 06 vv)
41 m5 rr	00 00 01	00 - 7F	REVERB SEND LEVEL	0.0 - 1.0 Multiplicand of the part reverb level (= Bn 63 1D 62 rr 06 vv)
41 m6 rr	00 00 01	00 - 7F	CHORUS SEND LEVEL	0.0 - 1.0 Multiplicand of the part chorus level (= Bn 63 1E 62 rr 06 vv)
41 m7 rr	00 00 01	00 - 01	Rx. NOTE OFF	OFF / ON
41 m8 rr	00 00 01	00 - 01	Rx. NOTE ON	OFF / ON

*When you change Drum Sets, all values of the DRUM SETUP PARAMETERS will be initialized.

■ Bulk Dump

You can send or request bulk data which contains a large amount of parameter data using Bulk Dump communication. A Bulk dump is used for storing data in a sequencer or a computer.

To send or request bulk data, use the Address and Size indicated in the following map.

You cannot use any address having "#" for the top address in a System Exclusive message except in the following case.

Messages which include large amounts of data (more than 128 bytes) are sent out in separate packets. The top address of the following messages may be the address marked "#".

To send several packets of large DT1 messages at a time, insert intervals of at least 40ms.in between those packets.

● **All Parameters**
(System Parameters and all Patch Parameters)

Address (H)	Size (H)	Description	Number of packets
48 00 00	00 1D 10		
#		ALL	30 packets
48 1D 0F #			

● **System Parameters**

Address (H)	Size (H)	Description	Number of packets
48 00 00	00 00 10		
#		SYSTEM PARAMETERS	1 packet
48 00 0F #			

● **Patch Parameters**

Address (H)	Size (H)	Description	Number of packets
48 00 10	00 01 00		
#		PATCH COMMON	1 packet
48 01 0F #			
48 01 10	00 01 60		
#		BLOCK 0	2 packets
48 02 6F #			
48 02 70	00 01 60		
#		BLOCK 1	2 packets
48 04 4F #			
48 04 50	00 01 60		
#		BLOCK 2	2 packets
48 06 2F #			
48 06 30	00 01 60		
#		BLOCK 3	2 packets
48 08 0F #			
48 08 10	00 01 60		
#		BLOCK 4	2 packets
48 09 6F #			
48 09 70	00 01 60		
#		BLOCK 5	2 packets
48 0B 4F #			
48 0B 50	00 01 60		
#		BLOCK 6	2 packets
48 0D 2F #			
48 0D 30	00 01 60		
#		BLOCK 7	2 packets
48 0F 0F #			
48 0F 10	00 01 60		
#		BLOCK 8	2 packets
48 10 6F #			
48 10 70	00 01 60		
#		BLOCK 9	2 packets
48 12 4F #			
48 12 50	00 01 60		
#		BLOCK A	2 packets
48 14 2F #			
48 14 30	00 01 60		
#		BLOCK B	2 packets
48 16 0F #			
48 16 10	00 01 60		
#		BLOCK C	2 packets
48 17 6F #			
48 17 70	00 01 60		
#		BLOCK D	2 packets
48 19 4F #			
48 19 50	00 01 60		
#		BLOCK E	2 packets
48 1B 2F #			

48 1B 30	00 01 60		
#		BLOCK F	2 packets
48 1D 0F #			

● **DRUM SETUP PARAMETERS**

* m : Map number (0 = MAP1, 1 = MAP2)

Address (H)	Size (H)	Description	Number of packets
49 m0 00	00 02 00		
		PLAY NOTE NUMBER	2 packets
49 m1 7F			
49 m2 00	00 02 00		
		LEVEL	2 packets
49 m3 7F			
49 m4 00	00 02 00		
		ASSIGN GROUP NUMBER	2 packets
49 m5 7F			
49 m6 00	00 02 00		
		PANPOT	2 packets
49 m7 7F			
49 m8 00	00 02 00		
		REVERB SEND LEVEL	2 packets
49 m9 7F			
49 mA 00	00 02 00		
		CHORUS SEND LEVEL	2 packets
49 mB 7F			
49 mC 00	00 02 00		
		Rx. NOTE ON/OFF	2 packets
49 mD 7F			
49 mE 00	00 00 18		
		DRUM MAP NAME	1 packet
49 mE 17			

Micro Edit

Parameter values used in Exclusive messages can be modified directly using panel procedures.

*While in the Micro Edit status, press the INSTRUMENT buttons (◀ and ▶) simultaneously to transmit the displayed parameter values from MIDI OUT.

< Modifying System, Drum Set, and All Part parameters >

- After turning the **ALL** button indicator on, press the PART buttons (◀ and ▶) simultaneously.
- Press **ALL** and **MUTE** simultaneously two times quickly. The value (hexidecimal numbers) will be shown in the upper section of the display indicating the Micro Edit status.
- Use **ALL** **MUTE** to select the parameter address that you want to modify (in the Drum Set's case, use PART (◀ ▶) to select the note number).
- Use INSTRUMENT (◀ ▶) to modify the value.
- After pressing **ALL** and **MUTE** simultaneously, press the PART buttons (◀ and ▶) to finalize.

< Modifying parameters that can be set for each part >

- After turning the **ALL** button indicator off, press the PART buttons (◀ and ▶) simultaneously.
- Press **ALL** and **MUTE** simultaneously two times quickly. The value (hexidecimal numbers) will be shown in the upper section of the display indicating the Micro Edit status.
- Use PART (◀ ▶) to select the part.
- Use **ALL** **MUTE** to select parameter address that you want to modify.
- Use INSTRUMENT (◀ ▶) to modify the value.
- After pressing **ALL** and **MUTE** simultaneously, press the PART buttons (◀ and ▶) to finalize.

4. Useful Information

● Decimal and Hexadecimal

It is common to use 7-bit Hexadecimal numbers in MIDI communication. The following is a conversion table between decimal numbers and 7-bit Hexadecimal numbers.

Dec	Hex	Dec	Hex	Dec	Hex	Dec	Hex
0	00H	32	20H	64	40H	96	60H
1	01H	33	21H	65	41H	97	61H
2	02H	34	22H	66	42H	98	62H
3	03H	35	23H	67	43H	99	63H
4	04H	36	24H	68	44H	100	64H
5	05H	37	25H	69	45H	101	65H
6	06H	38	26H	70	46H	102	66H
7	07H	39	27H	71	47H	103	67H
8	08H	40	28H	72	48H	104	68H
9	09H	41	29H	73	49H	105	69H
10	0AH	42	2AH	74	4AH	106	6AH
11	0BH	43	2BH	75	4BH	107	6BH
12	0CH	44	2CH	76	4CH	108	6CH
13	0DH	45	2DH	77	4DH	109	6DH
14	0EH	46	2EH	78	4EH	110	6EH
15	0FH	47	2FH	79	4FH	111	6FH
16	10H	48	30H	80	50H	112	70H
17	11H	49	31H	81	51H	113	71H
18	12H	50	32H	82	52H	114	72H
19	13H	51	33H	83	53H	115	73H
20	14H	52	34H	84	54H	116	74H
21	15H	53	35H	85	55H	117	75H
22	16H	54	36H	86	56H	118	76H
23	17H	55	37H	87	57H	119	77H
24	18H	56	38H	88	58H	120	78H
25	19H	57	39H	89	59H	121	79H
26	1AH	58	3AH	90	5AH	122	7AH
27	1BH	59	3BH	91	5BH	123	7BH
28	1CH	60	3CH	92	5CH	124	7CH
29	1DH	61	3DH	93	5DH	125	7DH
30	1EH	62	3EH	94	5EH	126	7EH
31	1FH	63	3FH	95	5FH	127	7FH

*To indicate a decimal number for the MIDI channel, Bank number, and Program number, add one to the values in the table.

*The resolution of 7-bit Hexadecimal numbers is 128. Use several bytes for values which require higher resolution.
i.e. The number "ad bbH" in 7-bit Hexadecimal is "ad x 128 + bb" in Decimal form.

*A signed number (with a sign +/−) is indicated as 00H = −64, 40H = +0, 7FH = +63.
So the signed number "aaH" in 7-bit Hexadecimal is "ad − 64" (ad is the decimal number of aaH).

In the case of two bytes, it is regarded as 00 00H = −8192, 40 00H = +0, 7F 7FH = +8191.
So the signed number "ad bbH" in 7-bit Hexadecimal is "ad bbH − 40 00H = ad x 128 + bb − 64 x 128", where, ad and bb is the decimal number of aaH and bbH respectively.

*The data indicated as "nibbled" is a 4-bit Hexadecimal number.
i.e. "0a 0bH" is "a x 16 + b".

< Example 1 > Convert "5AH" in Hexadecimal to a Decimal number.
(By using the table) 5AH = 90

< Example 2 > Convert "12 34H" in 7-bit Hexadecimal to a Decimal number.
(By using the table) 12H = 18, 34H = 52
So, 18 x 128 + 52 = 2356

< Example 3 > Convert "0A 03 09 0D" in nibbled form to a Decimal number.
(By using the table) 0AH = 10, 03H = 3, 09H = 9, 0DH = 13
So, ((10 x 16 + 3) x 16 + 9) x 16 + 13 = 41885

< Example 4 > Convert "1258" in Decimal form to a nibbled number.

```

16 ) 1258
    ) 78...10
16 ) 4...14
    )
    0...4

```

(By using the table) 0 = 00H, 4 = 04H, 14 = 0EH, 10 = 0AH
So, 00 04 0E 0AH

● Example of actual MIDI messages

< Example 1 > 92 3E 5F

"9n" is a status of a Note On message, and "n" is a MIDI channel number.
The second byte is the Note number, and the third is Velocity.
2H = 2, 3EH = 62, 5FH = 95
So, this is a Note On message of MIDI channel = 3, Note number = 62 (D4) and Velocity = 95.

< Example 2 > CE 49

"Cn" is a status of a Program change message, and "n" is a MIDI channel number.
The second byte is a Program number.
EH = 14, 49H = 73
So, this is a Program change message of MIDI channel = 15, Program number = 74 (Flute in GS).

< Example 3 > EA 00 28

"EnH" is a status of a Pitch bend change message, and "n" is a MIDI channel number.
The second byte (00H) is an LSB and the third (28H) is an MSB of a Pitch bend value (± signed).
The Pitch bend value is:
28 00H − 40 00H = 40 x 128 + 0 −
(64 x 128 + 0) = 5120 − 8192 = −3072
So, this is a Pitch bend change message of MIDI channel = 11, Pitch bend value = −3072

If the Pitch bend sensitivity is set to 2 semitones, and the Pitch bend value −8192 (00 00H) is defined as −200 cents.
The actual pitch bend value of this message is:
−200 x (−3072) ÷ (−8192) = −75 cent

< Example 4 > B3 64 00 65 00 06 0C 26 00 64 7F 65 7F

"Bn" is a status of a Control change message, and "n" is a MIDI channel number.
The second byte is a Control number and the third is the value.
This packet uses the running status rule, that is, when you send a series of messages with the same status, you can omit the following status bytes.
This message contains:

```

B3 64 00 MIDI CH = 4  LSB of RPN parameter number : 00H
(B3) 65 00 MIDI CH = 4  MSB of RPN parameter number : 00H
(B3) 06 0C MIDI CH = 4  MSB of Data entry           : 0CH
(B3) 26 00 MIDI CH = 4  LSB of Data entry           : 00H
(B3) 64 7F MIDI CH = 4  LSB of RPN parameter number : 7FH
(B3) 65 7F MIDI CH = 4  MSB of RPN parameter number : 7FH

```

This message string means 'send data "0C 00H" to RPN parameter number "00 00H", after that, set RPN parameter number to "7F 7F".

RPN parameter number "00 00H" is Pitch bend sensitivity and the unit of the MSB value is a semitone, so 0CH = 12 is a value to set the Pitch bend sensitivity = 12 semitones (one octave).

GS devices ignore the LSB value of Pitch bend sensitivity. However, you had better send both MSB and LSB (=00H) to maintain data compatibility.

Once an RPN or NRPN number is set, all the Data entry messages sent after are effective.

Sometimes this rule may cause a problem if the MIDI data is played by a sequencer and it is operated in fast forward or backward mode. It is recommended, therefore, to set the RPN or NRPN number to 7F 7FH after sending the Data entry messages.

*To use running-status for several MIDI events like < example 4 > in song data (e.g. Standard MIDI File data) is not recommended. There may be a sequencer which can not handle such data correctly when it is operated in fast forward or rewind mode. Entering a status byte for every event is the reliable way.

*The parameter number and the value of RPN or NRPN must be sent in correct order. As some sequencers may send the recorded data in a different order (if an event is too close to another), it is recommended to place each event on a different tick. (e.g. 1 tick deviation for TPQN = 92, or 5 ticks for TPQN = 480 is recommended.)

● Example and Checksum of Roland System Exclusive messages

Roland System Exclusive messages (RQ1 and DT1) have a Checksum at the end of the data (just before EOX) to be able to check for communication errors. The Checksum is determined by values of address and data (or size) included in the message.

<How to calculate Checksum> ("H" Indicates Hexadecimal.)

The error checking process employs a sum-check error detection. It provides binary bit figures whose lower 7 bits are zero when values for an address, data (or size) and the Checksum are summed.

One practical equation to determine Checksum is:

If the address is "ad bb ccH" and the data (or the size) is "dd ee ffH"
 $ad + bb + cc + dd + ee + ff = \text{sum}$
 $\text{sum} \div 128 = \text{quotient} \dots \text{remainder}$
 $128 - \text{remainder} = \text{checksum}$

< Example 1 > Set "REVERB MACRO" to "ROOM 3"

According to the Parameter Address Map, the Address of REVERB MACRO is 40 01 30H, and the Value correspond to ROOM 3 is 02H. So, the message should be:

F 0	4 1	1 0	4 2	1 2	4 0	0 1	3 0	0 2	??	F 7							
--	--	--	--	--	--	--	--	--	--	--							
(1)	(2)	(3)	(4)	(5)	address			data	checksum	(6)	(1) Exclusive Status	(2) ID	(3) Device ID	(16)	(4) Model ID (GS)	(5) Command ID (DT1)	(6) End of Exclusive

The Checksum is:

$40H + 01H + 30H + 02H = 64 + 1 + 48 + 2 = 115 \text{ (sum)}$
 $115 \text{ (sum)} \div 128 = 0 \text{ (quotient)} \dots 115 \text{ (remainder)}$
 $\text{checksum} = 128 - 115 \text{ (remainder)} = 13 = 0DH$

Therefore, the message to send is : F0 41 10 42 12 40 01 30 02 0D F7

< Example 2 > To request LEVEL of NOTE NUMBER 75 (D#5; Claves) in DRUM MAP 1

NOTE NUMBER 75 (D#5) is 4BH in Hexadecimal.

The Address of "LEVEL of NOTE NUMBER 75 (D#5; Claves) in DRUM MAP 1" is 41 02 4BH, and the size is 00 00 01H. So, the message should be :

F 0	4 1	1 0	4 2	1 1	4 1	0 2	4 B	0 0	0 0	0 1	??	F 7						
--	--	--	--	--	--	--	--	--	--	--	--	--						
(1)	(2)	(3)	(4)	(5)	address		size	checksum			(6)	(1) Exclusive Status	(2) ID	(3) Device ID	(16)	(4) Model ID (GS)	(5) Command ID (RQ1)	(6) End of Exclusive

The Checksum is:

$41H + 02H + 4BH + 00H + 00H + 01H = 65 + 2 + 75 + 0 + 0 + 1 = 143 \text{ (sum)}$
 $143 \text{ (sum)} \div 128 = 1 \text{ (quotient)} \dots 15 \text{ (remainder)}$
 $\text{checksum} = 128 - 15 \text{ (remainder)} = 113 = 71H$

Therefore, the message to send is : F0 41 10 42 11 41 02 4B 00 00 01 71 F7

< Example 3 > Set "MASTER TUNE" to +23.4 cents by System Exclusive

The Address of "MASTER TUNE" is 40 00 00H.

The Value should be nibblized data whose resolution is 0.1 cents, and which is a signed value

(00 04 00 00H (= 1024) = ± 0).

+ 23.4 [cents] = 234 + 1024 = 1258 = (hexadecimal) => 04 EAH = (nibblized) => 00 04 0E 0AH

So, the message should be :

F 0	4 1	1 0	4 2	1 2	4 0	0 0	0 0	0 0	0 4	0 E	0 A	??	F 7						
--	--	--	--	--	--	--	--	--	--	--	--	--	--						
(1)	(2)	(3)	(4)	(5)	address			data	checksum			(6)	(1) Exclusive Status	(2) ID	(3) Device ID	(16)	(4) Model ID (GS)	(5) Command ID (DT1)	(6) End of Exclusive

The Checksum is:

$40H + 00H + 00H + 00H + 04H + 0EH + 0AH = 64 + 0 + 0 + 0 + 4 + 14 + 10 = 92 \text{ (sum)}$
 $92 \text{ (sum)} \div 128 = 0 \text{ (quotient)} \dots 92 \text{ (remainder)}$
 $\text{checksum} = 128 - 92 \text{ (remainder)} = 36 = 24H$

Therefore, the message to send is : F0 41 10 42 12 40 00 00 04 0E 0A 24 F7

MIDI Implementation Chart

Function ...		Transmitted	Recognized	Remarks
Basic Channel	Default	x	1 - 16	Memorized
	Changed	x	1 - 16	
Mode	Default	x	Mode 3	* 2
	Messages	x	Mode 3, 4 (M = 1)	
	Altered	*****		
Note Number	: True Voice	x	0 - 127	
		*****	0 - 127	
Velocity	Note ON	x	○	
	Note OFF	x	x	
After Touch	Key's	x	○ * 1	
	Ch's	x	○ * 1	
Pitch Bend		x	○ * 1	
Control Change	0, 32	x	○ * 1	Bank select
	1	x	○ * 1	Modulation
	5	x	○ * 3	Portamento time
	6, 38	x	○ * 3	Data entry
	7	x	○ * 1	Volume
	10	x	○ * 1	Panpot
	11	x	○ * 1	Expression
	64	x	○ * 1	Hold1
	65	x	○ * 1	Portamento
	66	x	○ * 1	Sostenuto
	67	x	○ * 1	Soft
	84	x	○ * 1	Portamento control
	91	x	○ (Reverb) * 3	Effect1 depth
	93	x	○ (Chorus) * 3	Effect3 depth
	98, 99	x	○ * 1	NRPN LSB, MSB
	100, 101	x	○ * 1	RPN LSB, MSB
	120	x	○	All sounds off
121	x	○	Reset all controllers	
Prog Change	: True #	○	* 1	Prog.Number 1 - 128
		*****	0 - 127	
System Exclusive		○	* 1	
System Common	: Song Pos	x	x	
	: Song Sel	x	x	
	: Tune	x	x	
System Real Time	: Clock	x	x	
	: Commands	x	x	
Aux Messages	: Local ON/OFF	x	x	
	: All Notes OFF	x	○ (123 - 125)	
	: Active Sense	○	○	
	: Reset	x	x	
Notes		* 1 ○x is selectable. * 2 Recognize as M = 1 even if M ≠ 1. * 3 ○x is selectable, only when using the receive switch control change (all).		

Mode 1 : OMNI ON, POLY
 Mode 3 : OMNI OFF, POLY

Mode 2 : OMNI ON, MONO
 Mode 4 : OMNI OFF, MONO

○ : Yes
 x : No

■ How to read a MIDI Implementation Chart

○ : MIDI data that can be transmitted or received.

× : MIDI data that cannot be transmitted or received.

● Basic Channel

The MIDI channel for transmitting (or receiving) MIDI data can be specified over this range. The MIDI channel setting is retained even when the power is turned off.

● Mode

Most recent keyboards use mode 3 (omni off, poly).

Reception: MIDI data is received only on the specified channels, and played polyphonically.

Transmission: All MIDI data is transmitted on the specified MIDI channel.

* "Mode" refers to MIDI Mode messages.

● Note Number

This is the range of note numbers that can be transmitted (or received). Note number 60 is middle C (C4).

● Velocity

This is the range over which velocity can be transmitted (or received) by Note On and Note Off messages.

● Aftertouch

Key's : Polyphonic Key Pressure

Ch's : Channel Pressure

● Pitch Bend

The bend range setting of each Tone determines the range of pitch change caused by Pitch Bend messages. When set to 0, Pitch Bend messages will be ignored.

● Control Change

This indicates the control numbers that can be transmitted (or received), and what they will control. For details, refer to the MIDI implementation.

● Program Change

The program numbers in the chart indicate the actual data. (This is one less than the instrument program numbers.)

● Exclusive

Exclusive message reception can be turned On/Off.

● Common, Real time

These MIDI messages are used to synchronize sequencers and rhythm machines. The Sound Canvas does not use these messages.

● Aux messages

These messages are mainly used to keep a MIDI system running correctly.

Active sensing transmission can be turned on/off.

TABLE OF OPERATIONS

● All parts and System function settings (When the **[ALL]** indicator is on)

All parts	Volume Level	0— 127	LEVEL ◀▶	P.19
	Pan	L63—0—R63	PAN ◀▶	P.19
	Reverb	0— 64 —127	REVERB ◀▶	P.20
	Chorus	0— 64 —127	CHORUS ◀▶	P.20
	Key Shift	- 24—0— + 24	KEY SHIFT ◀▶	P.21
	All Mute	Off, On	[MUTE]	P.30
	All Monitor	Off, On	[ALL] * [MUTE]	P.32
	Master Tune	415.3— 440.0 —466.2Hz		P.33
	Reverb Type	Room1, 2, 3 Hall1, 2 Plate Delay Panning Delay		P.55
Chorus Type	Chorus1, 2, 3, 4 Feedback Chorus Flanger Short Delay Short Delay (FB)		P.55	
System function	Mute Lock	Off, On	PART ◀ * Part ▶ →	P.31
	Display	Type1~8	◀([ALL][MUTE]): Function selection →	P.43
	Peak Hold	Off, Type1~3	INSTRUMENT ◀▶: Set →	P.43
	LCD Contrast	1~8~16	PART ◀ * Part ▶: Complete	P.44
	Backup	Off, On		P.37
	Rx Remote	Off, On		P.9
	MIDI IN 1 ↔ 2	Off, On		P.35
	Rx SysEx	Off, On		P.79
	Rx GM On	Off, On		P.79
	Rx GS Reset	Off, On		P.79
	Rx Inst Chg	Off, On		P.47
	Rx FuncCtrl	Off, On		P.79
	Use Univ. Rt	Off, On		P.80
	Device ID number	1—17—32	MIDI CH ◀▶	P.76

- : Proceed to the next instruction
- [A] * [B]** : Press **[A]** and **[B]** simultaneously.
- () : Repeat the operation.

* Bold - faced values are the factory presets.

● Settings for each part (When the **ALL** indicator is off)

Instrument Selection	1—128	PART ◀▶ : Part selection → INSTRUMENT ◀▶	P.23
Drum Set Selection	---	PART ◀▶ : Drum part selection → INSTRUMENT ◀▶	P.24
Volume Level	0— 100 —127	PART ◀▶ : Part selection → LEVEL ◀▶	P.27
Pan	Rnd, L63— 0 —R63	PART ◀▶ : Part selection → PAN ◀▶	P.27
Reverb	0— 40 —127	PART ◀▶ : Part selection → REVERB ◀▶	P.27
Chorus	0—127	PART ◀▶ : Part selection → CHORUS ◀▶	P.27
Key Shift	- 24— 0 — + 24	PART ◀▶ : Part selection → KEY SHIFT ◀▶	P.27
MIDI Receive Channel	1—16, Off	PART ◀▶ : Part selection → MIDI CH ◀▶	P.63
Part Mute	Off, On	PART ◀▶ : Part selection → MUTE	P.30
Part Monitor	Off, On	PART ◀▶ : Part selection → ALL * MUTE	P.32
Part Mode	Norm, Drum1, Drum2	PART ◀ * PART ▶ → PART ◀▶ : Part selection → (ALL MUTE): Function selection → INSTRUMENT ◀▶ : Set) → PART ◀ * PART ▶ : Complete	P.25
M/P Mode	Poly , Mono		P.51
Voice Reserve	0—24		P.57
Fine Tune	- 12.0— 0.0 — + 12.0		P.33
Rx Bank Sel	Off, On		P.77
Rx NRPN	Off, On		P.77
Bend Range	- 24— +2 — + 24		P.51
Modulation Depth	0— 10 —127		P.51
Key Range L	C-1 —G9		P.51
Key Range H	C-1 —G9		P.51
Velocity Sens Depth	0— 64 —127		P.51
Velocity Sens Offset	0— 64 —127		P.51
Vib. Rate	- 50— 0 — + 50		P.54
Vib. Depth	- 50— 0 — + 50		P.54
Vib. Delay	- 50— 0 — + 50		P.54
Cutoff Freq.	- 50— 0 — + 16		P.54
Resonance	- 50— 0 — + 50		P.54
Attack Time	- 50— 0 — + 50		P.54
Decay Time	- 50— 0 — + 50		P.54
Release Time	- 50— 0 — + 50		P.54
Modulation	0 —127		P.51
Expression	0— 127		P.51
Portamento	Off, On		P.51
Portamento Time	0 —127	P.51	

- : Proceed to the next instruction
- A** + **B** : While holding **A**, press **B**.
- A** * **B** : Press **A** and **B** simultaneously.
- A** * **B** + power on : While holding **A** and **B**, turn the power on.
- () : Repeat the operation.

* Bold - faced values are the factory presets that are common to each part.

● Other functions

ROM play	Set to ROM play status	PART [◀] * PART [▶] + power on	P.17
	Select song	PART [◀▶]	
	Play start	[ALL]	
	Play stop	[MUTE]	
	Cancel ROM play status	PART [◀] * PART [▶]	
USER function	USER ON, USER OFF	LEVEL [▶] * REVERB [▶]	P.28
	Clear the setting	PAN [◀] * CHORUS [◀] ⇒ [ALL]: execute	P.29
Minus-one Play		LEVEL [◀] * REVERB [◀]	P.34
Storing/calling up the settings of the SOUND Canvas	Store	[ALL]: indicator on ⇒ PART [◀] * INSTRUMENT [◀] ⇒ [ALL]: execute	P.41
	Call	[ALL]: indicator on ⇒ PART [◀] * INSTRUMENT [▶] ⇒ [ALL]: execute	P.41
Sound arrangement of MT-32		INSTRUMENT [◀] + Turn the power on ⇒ [ALL]: execute	P.38
Initialization for GM system		PART [◀] + Turn the power on ⇒ [ALL]: execute	P.36
Initialization for GS format		INSTRUMENT [▶] + Turn the power on ⇒ [ALL]: execute	P.36
Returning to factory presets		INSTRUMENT [◀] * INSTRUMENT [▶] + Turn the power on [ALL]: execute	P.37
Selection of Variation		[ALL]: Indicator light off ⇒ PART [◀▶]: select the part that you want to change ⇒ INSTRUMENT [◀▶]: change to an instrument that has variation ⇒ INSTRUMENT [◀] * [▶] ⇒ INSTRUMENT [◀▶]: Select variation ⇒ INSTRUMENT [◀] * [▶]	P.45
Transmission of basic settings (SETUP SEND)	All parts and settings of the specified part	[ALL]: indicator off {PART [◀▶]: select the part you don't want to transmit ⇒ [MUTE]: Mute on} ⇒ [ALL]: indicator on (GS Setup Send) PART [▶] * INSTRUMENT [◀] ⇒ [ALL]: execute (GM Setup Send) K SHIFT [▶] * MIDI CH [◀] ⇒ [ALL]: execute	P.59
	Specified part settings	[ALL]: indicator off {PART [◀▶]: select the part you don't want to transmit ⇒ [MUTE]: Mute on} ⇒ (GS Setup Send) PART [▶] * INSTRUMENT [◀] ⇒ [ALL]: execute (GM Setup Send) K SHIFT [▶] * MIDI CH [◀] ⇒ [ALL]: execute	P.59
Transmission of Sound Canvas settings	All settings of the Sound Canvas	[ALL]: indicator on ⇒ INSTRUMENT [◀] * INSTRUMENT [▶] ⇒ [ALL]: execute	P.60
	All parts and settings of the specified part	[ALL]: indicator off ⇒ {PART [◀▶]: select the part you don't want to transmit ⇒ [MUTE]: Mute on} ⇒ [ALL]: indicator on ⇒ PART [◀] * PART [▶] ⇒ INSTRUMENT [◀] * INSTRUMENT [▶] ⇒ [ALL]: execute	P.61
	Specified part settings	[ALL]: indicator light off ⇒ {PART [◀▶]: select the part you don't want to transmit ⇒ [MUTE]: Mute on} ⇒ PART [◀] * PART [▶] ⇒ INSTRUMENT [◀] * INSTRUMENT [▶] ⇒ [ALL]: execute	P.62
Changing the Patch name		[ALL]: indicator light on ⇒ PAN [▶] * CHORUS [▶] {PART [◀▶]: move the cursor ⇒ INSTRUMENT [◀▶]: select character PAN [▶] * CHORUS [▶]	P.40

OPERATION BLOCK DIAGRAM

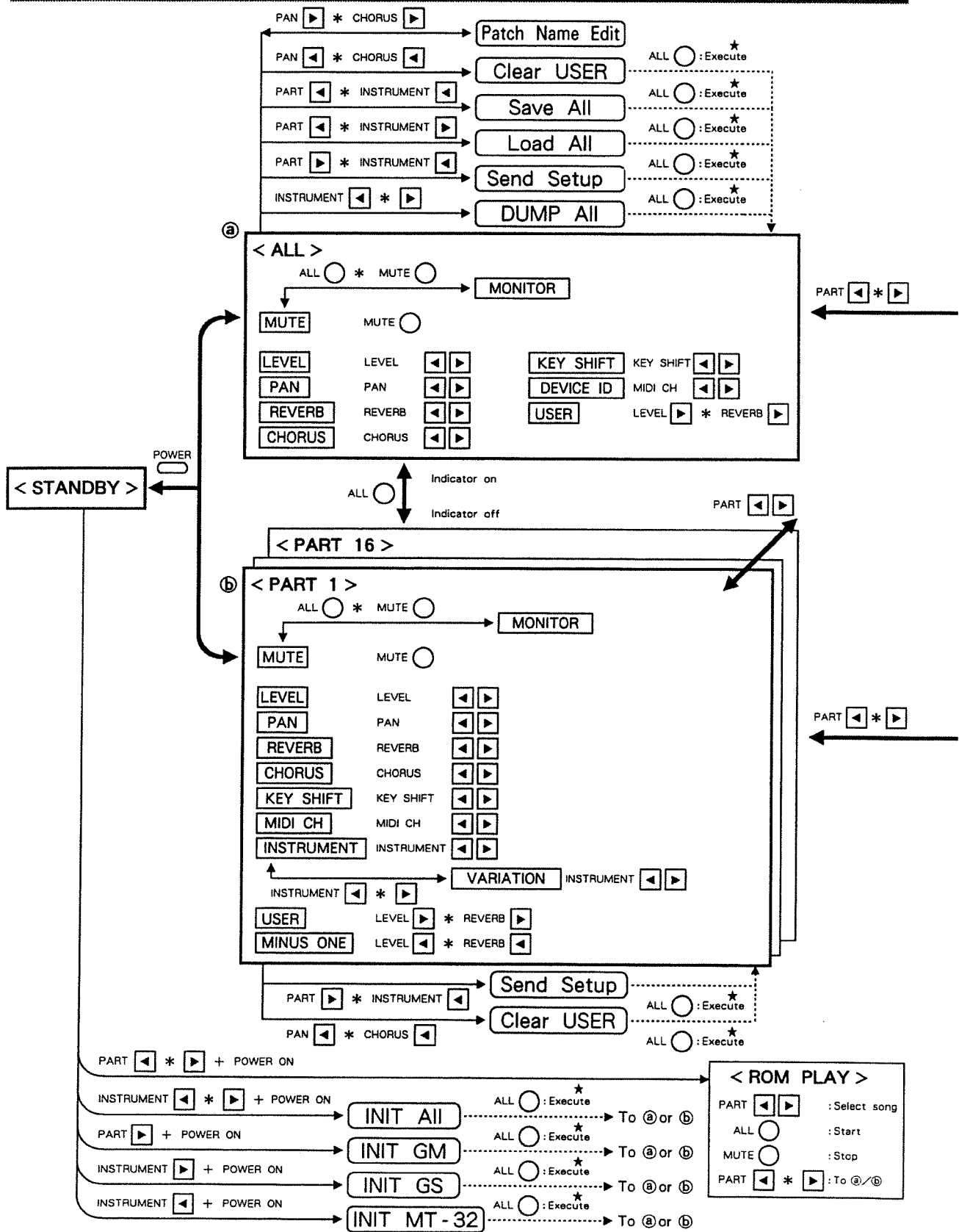

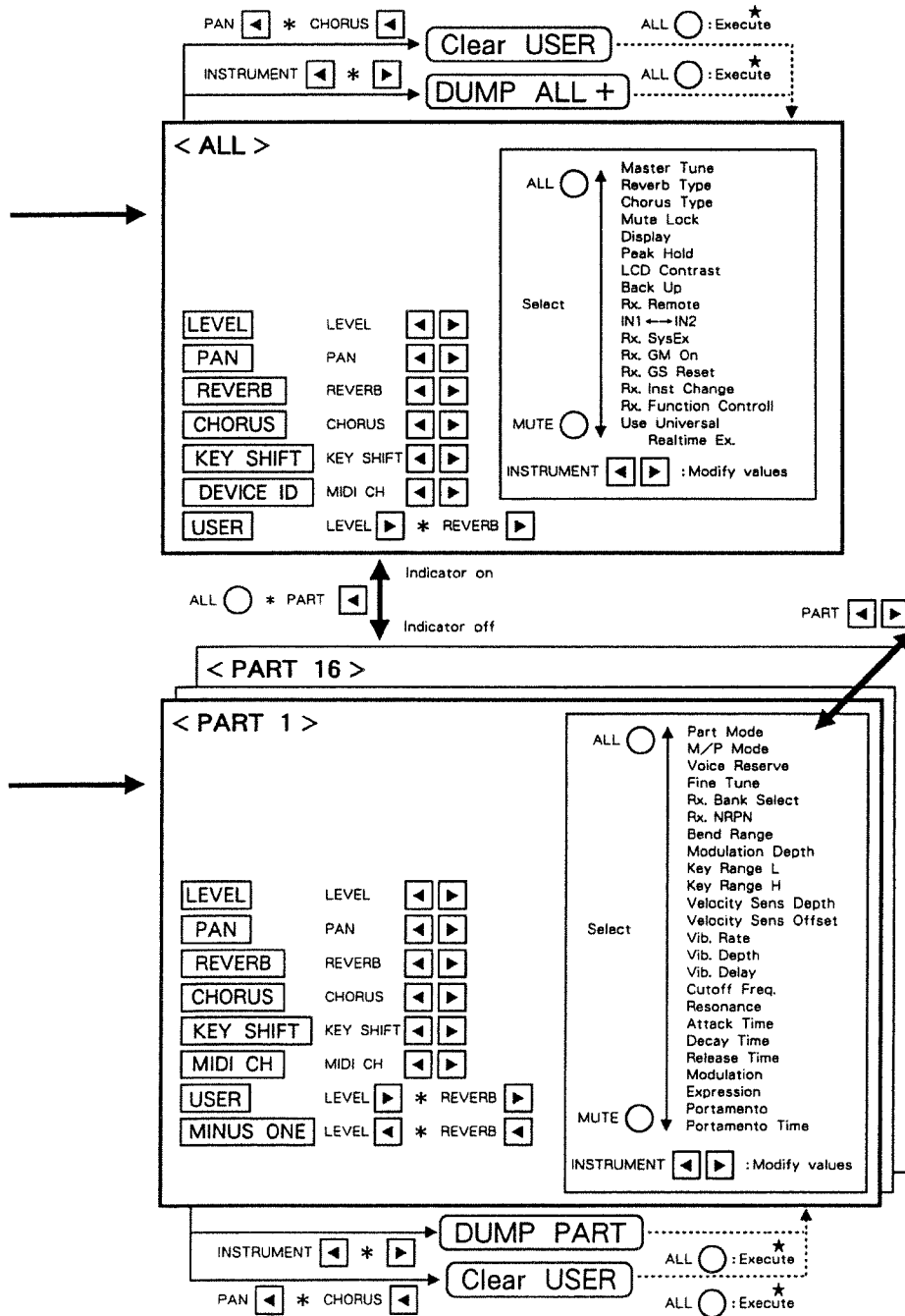

A * B = Press A and B simultaneously
 A + POWER ON = While holding A, turn the power on.
 ★ = MUTE ○ : Cancel

INDEX

[A]

AC adaptor	16
Active Sensing	74
Aftertouch	73
All Note Off	74
All Sound Off	74
Apple Macintosh Series	12
Attack Time	53

[B]

Backup Switch	37
Bank Select	46,77
Bar Display	42
Battery	5
Bend Range	48
Bulk Dump Data	60

[C]

Capital	45
Channel Pressure	74
Chorus	
Chorus Type	55
Part Chorus	27
Chorus Send Level	72
CM – 64/32L	89
Control Change	72
Contrast (Display)	44
Computer Cable	12,82
Computer Switch	15
Cord Hook	16
Cutoff Frequency	53

[D]

Data Entry	73
Decay Time	53
Demo Songs	16
Device ID	76
Display	42
Display Contrast	44
Drum Part	24,69
Drum Set	24
Dump Data	60

[E]

Effect	20,26,55
Error Message	67
Exclusive Message	75,78

Expression	51
------------	----

[F]

Factory Preset	37
Fine Tune	33
Function Control	78

[G]

GM Initialize	36
GM System	81
GM System On	79
GS Format	81
GS Initialize	36
GS Reset	79

[H]

Headphones	16
Hold 1	72

[I]

IBM PC AT Series	13
IN1 ↔ IN2 Switch	35,70
Initialization	36
Instrument	22,78

[K]

Key Pressure	74
Key Range H	48
Key Range L	48
Key Shift	
All Key Shift	21
Part Key Shift	27

[L]

LCD Contrast	44
Level	
All Level	19
Part Level	27

[M]

Maximum Polyphony	56
M/P Mode	50
Master Tune	33
Micro Edit	102

MIDI 68
MIDI IN1 ↔ IN2 switch 35,70
MIDI Implementation 90
MIDI Implementation chart 105
MIDI Channel 63,69
MIDI Connector 68,70
Minus One 34
Modulation 72
Modulation Depth 48
Monitor
 All Monitor 32
 Part Monitor 32
Mono 50
MT - 32 38,89
Multi - Timbral Sound Module 22,69
Mute
 All Mute 30
 Part Mute 30
Mute Lock 31

[N]

Normal Part 25,69
Note Message 71
Note Name 71
Note Number 71
NRPN 73,77

[P]

Pan 72
 All Pan 19
 Part Pan 27
Part 22
Part Mode 25
Patch Name 40
Peak Hold 42
Pitch Bend Change 71
Poly 50
Polyphonic Key Pressure 74
Polyphony(Maximum) 56
Portamento 50,73
Portamento Control 73
Portamento Time 50,73
Positioning 26
Power 7
Program Change 72

[R]

Release Time 54

Remote Control 8
Reset All Controllers 74
Resonance 53
Reverb
 Reverb Type 55
 Part Reverb 26
Reverb Send Level 73
ROM Play 17
RPN 73
Rx.Bank sel 77
Rx.Func Ctrl 78
Rx.GM On 79
Rx.GS Reset 79
Rx.Inst Chg 47,78
Rx.NRPN 77
Rx.Remote 9
Rx.SysEx 78

[S]

Setup Send 58
SFX 89
Soft 72
Soft Thru 15
Sostenuto 72
System Exclusive Message 75,78

[T]

Troubleshooting 66
Tuning 33

[U]

Use Univ.Rt 58,80
User Function 28
Universal Master Volume 80
Universal Realtime Exclusive 80

[V]

Velocity Sens Depth 49
Velocity Sens Offset 49
Vibrato Delay 52
Vibrato Depth 52
Vibrato Rate 52
Voice Reserve 57
Volume 19,26, 72
Variation 45

SPECIFICATIONS

SC-55mk II SOUND Canvas (General MIDI System / GS Format)

SOUND Canvas

● Number of parts

16 (Two parts can be set as drum parts)

● Maximum Polyphony

28 (voices)

● Effects

Reverb

Chorus

● Display

70.6 x 24.5mm (backlit LCD)

● Connectors

MIDI connectors (IN 1, IN 2, OUT, THRU)

Audio Input jack × 2 (L, R)

Audio Output jack × 2 (L, R)

Headphone jack

Computer terminal

● Power supply

DC 9V (AC adaptor)

● Current Draw

600 mA

● Dimensions

218 (W) × 233 (D) × 44 (H) mm

8 - 5/8 (W) × 9 - 3/16 (D) × 1 - 3/4 (H) inches

Half - rack mounting type

● Weight

1.4 kg

3 lbs 2 oz

Remote control unit

● Operating range

Distance: approximately 5 m

Angle: 40 degrees

● Power supply

DC 3V (CR2025 lithium battery)

● Dimensions

54 (W) × 85.5 (D) × 4.9 (H) mm

2 - 1/8 (W) × 3 - 3/8 (D) × 3/16 (H) inches

Accessories

Owner's manual

AC adaptor

MIDI cable (1 m) × 1

Remote control unit

Lithium battery (CR2025)

Audio cable (RCA pin ↔ RCA pin < 1/4 inch phone type >)

* The included MIDI cable is for MIDI only. It cannot be used for other purposes.

Options

Rack mount adaptor (RAD - 50)

Computer cable

RSC - 15AT (For IBM PC AT)

RSC - 15APL (For Apple Macintosh)

* The specifications for this product are subject to change without prior notice.

Program number
(Number of voices)
Instrument name

SOUND Canvas INSTRUMENT TABLE

Piano	1	(1)	3	(1)	4	(2)	5	(1)	6	(1)	7	(1)	8	(1)
	Piano 1		Piano 3		Honky-Tonk Piano		E. Piano 1		E. Piano 2		Harpischord		Clav.	
Chromatic	9	(1)	11	(1)	12	(1)	13	(1)	14	(1)	15	(1)	16	(1)
Percussion	Celesta		Music Box		Vibraphone		Marimba		Xylophone		Tubular-bell		Santur	
Organ	17	(1)	19	(1)	20	(1)	21	(1)	22	(2)	23	(1)	24	(2)
	Organ 1		Organ 3		Church Org. 1		Reed Organ		Accordion Fr		Harmonica		Bandoneon	
Guitar	25	(1)	27	(1)	28	(1)	29	(1)	30	(1)	31	(1)	32	(1)
	Nylon-str. Gt		Jazz Gt.		Clean Gt.		Muted Gt.		Overdrive Gt		DistortionGt		Gt. Harmonics	
Bass	33	(1)	35	(1)	36	(1)	37	(1)	38	(1)	39	(1)	40	(2)
	Acoustic Bs.		Picked Bs.		Fretless Bs.		Slap Bass 1		Slap Bass 2		Synth Bass 1		Synth Bass 2	
Strings/orchestra	41	(1)	43	(1)	44	(1)	45	(1)	46	(1)	47	(1)	48	(1)
	Violin		Cello		Contrabass		Tremolo Str		PizzicatoStr		Harp		Timpani	
Ensemble	49	(1)	51	(1)	52	(2)	53	(1)	54	(1)	55	(1)	56	(2)
	Strings		Syn. Strings1		Syn. Strings2		Choir Aahs		Voice Oohs		SynVox		OrchestraHit	
Brass	57	(1)	59	(1)	60	(1)	61	(2)	62	(1)	63	(2)	64	(2)
	Trumpet		Tuba		MutedTrumpet		French Horn		Brass 1		Synth Brass1		Synth Brass2	
Reed	65	(1)	67	(1)	68	(1)	69	(1)	70	(1)	71	(1)	72	(1)
	Soprano Sax		Tenor Sax		Baritone Sax		Oboe		English Horn		Bassoon		Clarinet	
Pipe	73	(1)	75	(1)	76	(1)	77	(2)	78	(2)	79	(1)	80	(1)
	Piccolo		Recorder		Pan Flute		Bottle Blow		Shakuhachi		Whistle		Ocarina	
Synth lead	81	(2)	83	(2)	84	(2)	85	(2)	86	(2)	87	(2)	88	(2)
	Square Wave		Syn. Calliope		Chiffer Lead		Charang		Solo Vox		5th Saw Wave		Bass&Lead	
Synth pad etc.	89	(2)	91	(1)	92	(2)	93	(2)	94	(2)	95	(2)	96	(1)
	Fantasia		Polysynth		Space Voice		Bowed Glass		Metal Pad		Halo Pad		Sweep Pad	
Synth SFX	97	(2)	99	(2)	100	(2)	101	(2)	102	(2)	103	(1)	104	(2)
	Ice Rain		Crystal		Atmosphere		Brightness		Goblin		Echo Drops		Star Theme	
Ethnic	105	(1)	107	(1)	108	(1)	109	(1)	110	(1)	111	(1)	112	(1)
	Sitar		Shamisen		Kolo		Kalimba		Bag Pipe		Fiddle		Shanai	
Percussive	113	(1)	115	(1)	116	(1)	117	(1)	118	(1)	119	(1)	120	(2)
	Tinkle Bell		Steel Drums		Woodblock		Taiko		Melo. Tom 1		Synth Drum		Reverse Cym.	
SFX	121	(1)	123	(2)	124	(2)	125	(1)	126	(1)	127	(2)	128	(1)
	Gt. FretNoise		Seashore		Bird		Telephone 1		Helicopter		Applause		Gun Shot	

The above items are Capital Instruments. For Variation Instruments see P.84.

SOUND Canvas DRUM SET TABLE

Note number	PC 1:STANDARD Set / PC 33:JAZZ Set	PC 9:ROOM Set	PC 17:POWER Set	PC 25: ELECTRONIC Set	PC 26:TR - 808 Set	PC 41: BRUSH Set	PC 49:ORCHESTRA Set
27	High Q						Closed Hi-Hat [EXC1]
28	Slap						Pedal Hi-Hat [EXC1]
29	Scratch Push [EXC7]						Open Hi-Hat [EXC1]
30	Scratch Pull [EXC7]						Ride Cymbal
31	Sticks						
32	Square Click						
33	Metronome Click						
34	Metronome Ball						
35	Kick Drum 2 / Jazz BD2					Jazz BD2	Concert BD 2
36	Kick Drum 1 / Jazz BD1		MONDO Kick	Elec BD	808 Bass Drum	Jazz BD1	Concert BD 1
37	Side Stick				808 Rim Shot		
38	Snare Drum 1		Gated SD	Elec SD	808 Snare Drum	Brush Tap	Concert SD
39	Hand Clap					Brush Slap	Castanets
40	Snare Drum 2			Gated SD		Brush Swirl	Concert SD
41	Low Tom 2	Room Low Tom 2	Room Low Tom 2	Elec Low Tom 2	808 Low Tom 2		Timpani F
42	Closed Hi - hat [EXC1]				808 CHH [EXC1]		Timpani F#
43	Low Tom 1	Room Low Tom 1	Room Low Tom 1	Elec Low Tom 1	808 Low Tom 1		Timpani G
44	Pedal Hi - hat [EXC1]				808 CHH [EXC1]		Timpani G#
45	Mid Tom 2	Room Mid Tom 2	Room Mid Tom 2	Elec Mid Tom 2	808 Mid Tom 2		Timpani A
46	Open Hi - hat [EXC1]				808 OHH [EXC1]		Timpani A#
47	Mid Tom 1	Room Mid Tom 1	Room Mid Tom 1	Elec Mid Tom 1	808 Mid Tom 1		Timpani B
48	High Tom 2	Room Hi Tom 2	Room Hi Tom 2	Elec Hi Tom 2	808 Hi Tom 2		Timpani c
49	Crash Cymbal 1				808 Cymbal		Timpani c#
50	High Tom 1	Room Hi Tom 1	Room Hi Tom 1	Elec Hi Tom 1	808 Hi Tom 1		Timpani d
51	Ride Cymbal 1						Timpani d#
52	Chinese Cymbal			Reverse Cymbal ★			Timpani e
53	Ride Bell						Timpani f
54	Tambourine						
55	Splash Cymbal						
56	Cowbell				808 Cowbell		
57	Crash Cymbal 2						Concert Cymbal 2
58	Vibra - slap						
59	Ride Cymbal 2						Concert Cymbal 1
60	High Bongo						
61	Low Bongo						
62	Mute High Conga				808 High Conga		
63	Open High Conga				808 Mid Conga		
64	Low Conga				808 Low Conga		
65	High Timbale						
66	Low Timbale						
67	High Agogo						
68	Low Agogo						
69	Cabasa						
70	Maracas				808 Maracas		
71	Short Hi Whistle [EXC2]						
72	Long Low Whistle [EXC2]						
73	Short Guiro [EXC3]						
74	Long Guiro [EXC3]						
75	Claves				808 Claves		
76	High Wood Block						
77	Low Wood Block						
78	Mute Culca [EXC4]						
79	Open Culca [EXC4]						
80	Mute Triangle [EXC5]						
81	Open Triangle [EXC5]						
82	Shaker						
83	Jingle Bell						
84	Bell Tree						
85	Castanets						
86	Mute Surdo [EXC6]						
87	Open Surdo [EXC6]						
88							Applause ★

PC # : Program number (drum set number)
 ★ : Tones which are created using two voices.
 (All other tones are created by one voice.)

Blank : Same as the percussion sound of "STANDARD"
 ----- : No sound
 [EXC] : Percussion sound of the same number will not be heard at the same time.

*In addition to the above, the SFX set and CM-32L (CM-64) set are also available (P.89).

Apparatus containing Lithium batteries

ADVARSEL!

Lithiumbatteri – Eksplosionsfare ved fejlagtig håndtering.
Udskiftning må kun ske med batteri af samme fabrikat og type.
Levér det brugte batteri tilbage til leverandøren.

VARNING!

Explosionsfara vid felaktigt batteribyte
Använd samma batterityp eller en ekvivalent typ som rekommenderas av apparattillverkaren.
Kassera använt batteri enligt fabrikantens instruktion.

ADVARSEL!

Lithiumbatteri – Eksplosjonsfare.
Ved utskifting benyttes kun batteri som anbefalt av apparatfabrikanten.
Brukt batteri returneres apparatleverandøren

VAROITUS!

Paristo voi räjähtää, jos se on virheellisesti asennettu.
Vaihda paristo ainoastaan laitevalmistajan suosittelemaan tyyppiin. Hävitä käytetty paristo valmistajan ohjeiden mukaisesti.

Bescheinigung des Herstellers/Importeurs

Hiermit wird bescheinigt, daß der/die/das

Roland Sound Canvas SC-55mkII

(Gerät. Typ. Bezeichnung)

in Übereinstimmung mit den Bestimmungen der

Amtsbl. Vfg 1046/1984

(Amtsblattverfügung)

funk-entstört ist.

Der Deutschen Bundespost wurde das Inverkehrbringen dieses Gerätes angezeigt und die Berechtigung zur Überprüfung der Serie auf Einhaltung der Bestimmungen eingeräumt.

Roland Corporation Osaka/Japan

Name des Herstellers/Importeurs

FEDERAL COMMUNICATIONS COMMISSION RADIO FREQUENCY INTERFERENCE STATEMENT

This equipment has been tested and found to comply with the limits for a Class B digital device, pursuant to Part 15 of the FCC Rules. These limits are designed to provide reasonable protection against harmful interference in a residential installation. This equipment generates, uses, and can radiate radio frequency energy and, if not installed and used in accordance with the instructions, may cause harmful interference to radio communications. However, there is no guarantee that interference will not occur in a particular installation. If this equipment does cause harmful interference to radio or television reception, which can be determined by turning the equipment off and on, the user is encouraged to try to correct the interference by one or more of the following measures:

- Reorient or relocate the receiving antenna.
- Increase the separation between the equipment and receiver.
- Connect the equipment into an outlet on a circuit different from that to which the receiver is connected.
- Consult the dealer or an experienced radio/TV technician for help.

Unauthorized changes or modification to this system can void the users authority to operate this equipment.

CLASS B

NOTICE

This digital apparatus does not exceed the Class B limits for radio noise emissions set out in the Radio Interference Regulations of the Canadian Department of Communications.

CLASSE B

AVIS

Cet appareil numérique ne dépasse pas les limites de la classe B au niveau des émissions de bruits radioélectriques fixés dans le Règlement des signaux parasites par le ministère canadien des Communications.

 Roland®

26055884

UPC

26055884



10981

