

BocaVision®

Network Devices

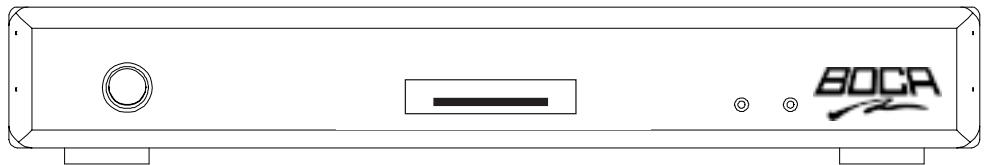

OWNER'S MANUAL

Model: STB121

with Citrix ICA® Support



Congratulations on your Purchase.

You are now the owner of BocaVision™ by Boca Research, Inc. Before you begin surfing the Net or accessing remote applications as a Windows-based terminal, please review the contents of this manual to simplify the installation process. The first section of this manual describes the product's features and how to connect the unit to your television set or a VGA monitor. The balance of the manual will guide you through the features and options of the network software and Internet Service Provider, as well as other useful reference information.

Write down the following information for your reference:

Model No. _____ The model number is located on the front cover of this owner's guide.
Serial No. _____ The serial number is located on the bottom of the unit.

Please locate the enclosed registration card, fill it out, and return it. Registering your product enables us to better serve you in the event your BocaVision unit requires service.

Boca Research is a leading manufacturer of data communications, videoconferencing, multimedia, and networking products to facilitate the transmission of information on PCs, networks, and/or the Internet.

Boca provides hardware products augmented with software for use in the corporate, consumer, and small office/home office marketplaces, and sells these products worldwide. Products are designed and manufactured in the U.S.A. with domestic and foreign parts, backed by a limited warranty, and various technical support options.

Boca Research's WEB address: <http://www.bocaresearch.com>



Avoid electric shock and fire hazard, keep this equipment away from moisture.

READ THESE SAFETY INSTRUCTIONS BEFORE INSTALLING AND OPERATING THIS EQUIPMENT

TO REDUCE THE RISK OF ELECTRIC SHOCK, DO NOT REMOVE COVER (OR BACK). THERE ARE NO USER-SERVICEABLE PARTS INSIDE. OBTAIN SERVICE FROM QUALIFIED SERVICE PERSONNEL.

Do not stack electronic components or any other objects on top of the unit. The slots on top of the unit must be left uncovered to permit necessary airflow to the unit. Obstructing the airflow could impair performance or damage other components.

Do NOT stack the unit on top of any other electrical component which radiates heat (e.g., audio amplifier).

For proper operating voltage, check the identification/rating label on the underside of the unit.

NOTE: FCC regulations state that unauthorized changes to this product could void your authority to operate it.

WARNING: Any changes to this unit, not approved by Boca Research, Inc. may void your warranty.



REGULATORY COMPLIANCE INFORMATION

Your BocaVision unit is registered with the Federal Communications Commission and complies with parts 15B and 68, FCC Rules and Regulations.

1. NOTIFICATION TO THE LOCAL TELEPHONE COMPANY

On the bottom of this equipment is a label indicating, among other information, the FCC Registration number and Ringer Equivalence Number (REN) for the equipment. You must, upon request, provide this information to your local telephone company.

The REN is useful in determining the number of devices you may connect to your telephone line and still have all these device ring when your telephone number is called. In most (but not all) areas, the sum of the RENs of all devices connected to one line should not exceed 5. To be certain of the number of devices you may connect to your line as determined by the REN, you should contact your local telephone company.

Notes: This equipment may not be used on coin service provided by the telephone company.

Party lines are subject to state tariffs, and therefore, you may not be able to use your own telephone equipment if you are on a party line. Check with your local telephone company.

Notice must be given to the telephone company upon permanent disconnection of your equipment from your line.

2. RIGHTS OF THE TELEPHONE COMPANY

Should your equipment cause you trouble on your line which may harm the telephone network, the telephone company, where practicable and the circumstances warrant such action, may temporarily discontinue service immediately. In case of such temporary discontinuance, the telephone company must: (1) promptly notify you of such temporary discontinuance, (2) afford you the opportunity to correct the situation, and (3) inform you of your right to bring a complaint to the Commission pursuant to procedures set forth in Subpart E of Part 68, FCC Rules and Regulations.

The telephone company may make changes in its communications facilities, equipment, operations or procedures where such action is required in the operation of its business and not inconsistent with FCC Rules and Regulations. If these changes are expected to affect the use or performance of your telephone equipment, the telephone company must give you adequate notice, in writing, to allow you to maintain uninterrupted service.

RADIO INTERFERENCE

This equipment has been tested and found to comply with the limits for a **Class B** digital device, in accordance with the specifications in Part 15 of FCC rules. These rules are designed to provide reasonable protection against radio and television interference in a residential installation. This equipment generates, uses, and can radiate radio frequency energy and, if not installed in accordance with the instructions, may cause harmful interference to radio communications. However, there is no guarantee that interference will not occur in a particular installation. If this equipment does cause interference to radio or television reception (which you can determine by turning the equipment off and on), try to correct the interference by one or more of the following measures:

- Re-orient or relocate the receiving antennae (that is, the antenna for radio or television that is "receiving" the interference).
- Change the position of the unit with respect to the radio or television equipment that is receiving interference.
- Move the unit away from the equipment that is receiving interference.
- Plug the unit into a different wall outlet so that the unit and the equipment receiving interference are on different branch circuits.

If these measures do not eliminate interference, please consult your dealer, or an experienced radio/television technician for additional suggestions. Also, the Federal Communications Commission has prepared a helpful booklet, "How to Identify and Resolve Radio/TV Interference Problems". This booklet is available from the U.S. Government Printing Office, Washington D.C. 20202. Please specify stock number 004-000-00345-4 when ordering copies.

Contents

Introduction	6	Browser User Interface	29
Summary of Features	6	Browser Toolbars	29
Getting Started	7	Main Toolbar	29
What's in the Box?	7	Go To	29
Connectors and LEDs	8	Secondary Toolbar	30
Connections	9	History	30
Connecting the Unit - Common Installation	9	Favorites	31
Connecting to a TV or VCR without A/V Jacks	10	Options	32
Connecting to a TV with S-VIDEO	11	Print	32
Connecting to a TV/VCR with A/V Jacks	12	Print Frames	32
Connecting to a Wireless Keyboard	13	Toolbar Buttons	33
Connecting to a PS/2-Compatible Keyboard	15	Progress Indicator	33
Connecting a Mouse	15	Up/Down Arrows	33
Connecting a Printer to the Parallel Port	16	Web Page Links	33
Connecting to a VGA Monitor	16	Button Types	33
Specifications	17	Submit Button	33
Network Software	18	Check Boxes	33
Introduction	18	Radio Buttons	33
On-Screen Display	18	Pop-up Menu Button	33
Color Palette	18	Text Entry Field	33
Screen Saver	18	Codec Controls	33
Power Off Request	18	Secure Socket Layer (SSL) Indicator	34
Smart Card	19	Web Page Password Challenge	34
Start-up Sequence	19	Image Map Cursor	34
Ready to Go Screen	19	Mouse Cursors	34
Welcome Screen	19	System Busy Indicator	34
Smart Card Screens	20	Frame Navigation Graphics	34
Begin Setup	20	Option Screens	35
Change ISP Details	21	Text Options	35
Change PIN	22	Printing Options	36
Invalid New PIN	23	Screen Positioning Options	36
Check for Smart Card	23	Sound Options	36
Smart Card Not Inserted	23	Telephone Options	37
Smart Card Not Valid	24	Call Waiting Options	37
Smart Card Damaged	24	ICA® Support	38
Check for Valid PIN	25	Troubleshooting	41
PIN Screens	25	Compatible Printers	43
Enter PIN	25	Accessories	44
Invalid PIN	25	Limited Warranty	45
Dialing Sequence	26	Servicing your Product	46
Dialing Screens	27	How to get Technical Assistance	47
Modem Status Screens	27		
Modem Error Messages	27		

Welcome...

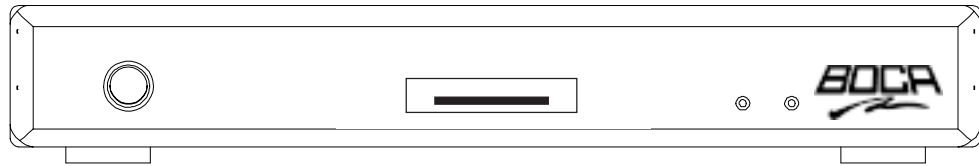

Our thanks for purchasing the Boca Research, Inc. BocaVision® Network Device. Designed as a television accessory or desktop Network access device*, this unit allows you to connect to the Internet via your TV or VGA monitor and a local standard analog telephone line.

* See the section on Citrix ICA® Support (page 38-40)

To access the Internet, you will need to subscribe to an Internet Service Provider (ISP); see pages 18-28. Connection instructions are detailed on pages 8-16.

Summary of Features

Components

- BocaVision STB unit
- IR keyboard with joystick mouse (batteries included)
- Owner's manual
- EZ Setup Guide
- Registration Card
- Smart card
- Cable pack

Cable Pack Includes:

- A/V cable (6 ft.)
- S-Video cable
- Telephone cable (25 ft.)
- Power Cord
- T-splitter
- Batteries (AA)

Connectors/Indicators

- Status LEDs: GREEN (power); RED (connect)
- Telephone jack
- VGA port
- RCA composite video output

- RCA right/left audio channels
- S-Video output
- Parallel port
- PS/2 keyboard port
- PS/2 mouse port
- Smart card slot
- Power connector

Features

Open ISP

Integrator's and/or user's choice for Internet service provider relationship:

- Local Phone #
- Password
- DNS information
- User-designated home page URL and web-based email URL
- User Name
- Domain name

- Video**
- 640x480x8 bits @60Hz
 - NTSC and VGA video mode
 - Vertical flicker control
 - Play AVI files

- Audio**
- Real Audio
 - WAV, AU, MIDI, SND, AIFF sound files

Telephony

- Call-waiting support with one-touch re-dial to ISP connection following incoming call

Printer

- Bidirectional parallel port connection for over 150 models including HP, Epson, Lexmark, Canon, Okidata, and more

Browser

- Full HTML 3.2 compatibility
- Dynamic horizontal scaling of Web pages
- SSL (Secure Socket Layer) encryption. Provides data encryption, server authentication, message integrity, and optional client authentication for a TCP/IP connection.

What's in the Box?

Before making connections, review the list below to ensure your package is complete.

- Network Device

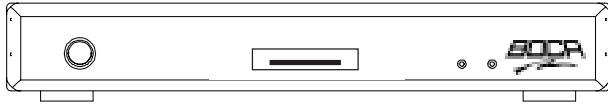

- Wireless keyboard/batteries

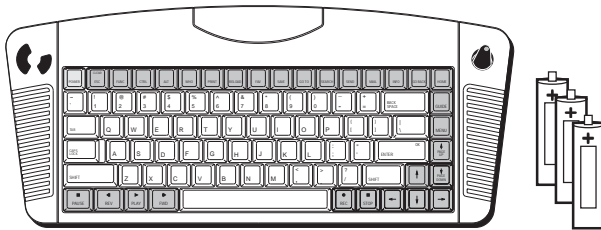

- AC power cord



- Phone cable

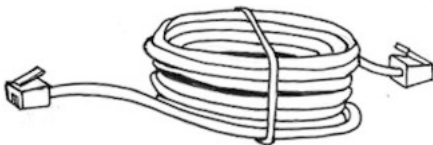

- Audio/Video cable

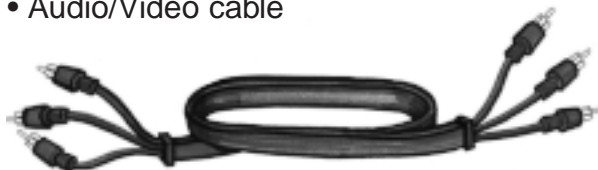

- S-Video cable



- Telephone line splitter

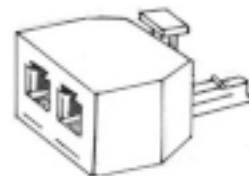

- Owner's Manual, EZ Setup Guide, and Registration Card

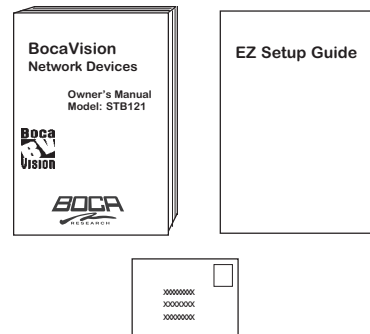

- Smart card



Connectors and LEDs

FRONT VIEW

- IR Receiver* _____
- Smart card Slot* _____
- Status LEDs*
- LED1**—Power (GREEN) _____
- LED2**—Connect (RED) _____

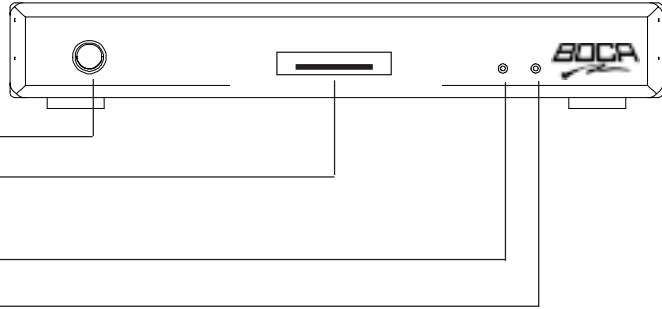

REAR VIEW:

Telephone jack (RJ-11). Attach one end of the supplied telephone cable to this jack and the other end to your phone outlet.

Printer parallel port (DB-25). Allows connection of printer to the unit, for printing of WEB pages.

VGA Monitor port. Use this port if you are connecting the unit to a computer monitor.

S-Video Output. Use this port if your television features an S-Video connector. S-Video may provide improved clarity of video display.

Composite video output. Use the video cable to connect this port to the VIDEO-IN jack on your TV.

Right/Left audio channels. Use the audio cables to connect these ports to the AUDIO-IN jacks on your TV.

Mouse. Connect a PS/2 compatible mouse.

Keyboard jack. Connect a PS/2 compatible personal computer keyboard.

AC Power connector. Connect the AC (110/220V) power cord here. Attach the other end to your wall outlet. **(MAKE THIS CONNECTION LAST).**

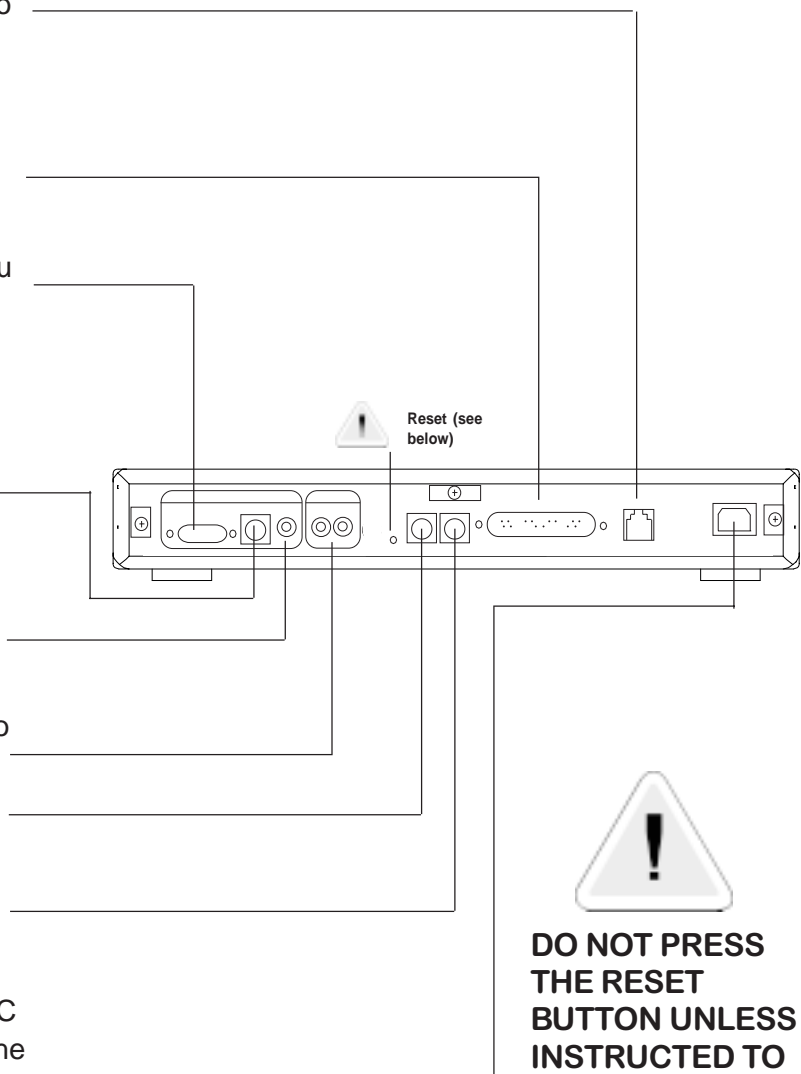



DO NOT PRESS THE RESET BUTTON UNLESS INSTRUCTED TO DO SO BY YOUR MANUFACTURER SERVICE REP.

Connections

Connecting the Unit

Before you can access the Internet, you need to connect the unit to:

- A. Your television set (directly or through your VCR), or VGA monitor.
- B. A telephone wall jack.
- C. An AC electrical outlet.

A common installation (TV or VCR with audio jacks) is depicted below. More detail is provided on page 12. Your connection choice depends on how your TV is set up:

1. Does your TV have S-VIDEO, RCA-type A/V (audio/video), or RF coaxial jacks?
2. Is your TV connected to a VCR?

IF YOU HAVE:	THEN:
A TV/VCR without Audio/ Jacks...	...see page 10
A TV with S-Video Jack...	...see page 11

NOTE: Connection to S-VIDEO may offer improved video display. To enhance audio performance, you may want to integrate the unit into your home entertainment system.

A. Television and VCR

Connect one end of the supplied RCA-type A/V cable to the BocaVision unit as identified and the other end to the A/V IN jacks on your TV or VCR. Make sure you match colors. If there is only one audio jack, connect the white plugs only.

NOTE: If connecting through your VCR, connect the VCR's A/V OUT jacks to the TV's A/V IN jacks. If using a coaxial cable for this connection, connect the coax OUT jack on your VCR to the coax VHF/UHF jack on your TV, using a coaxial connector cable (not supplied). You will need either a coaxial cable, or an RCA-type A/V cable, but not both.

B. Telephone

Connect one end of the telephone cable to the unit's telephone jack. Connect the other end to the telephone wall jack. For best results, connect the unit to a telephone wall jack that you are not currently using. If you have only one telephone wall jack, use the supplied T-splitter so the unit and the phone can share the same line.

C. Power

Connect the proper end of the AC power cord to the unit's power receptacle and then plug in (**DO THIS LAST**).

***NOTE:** For best results, connect the unit to a telephone wall jack that you are not currently using.

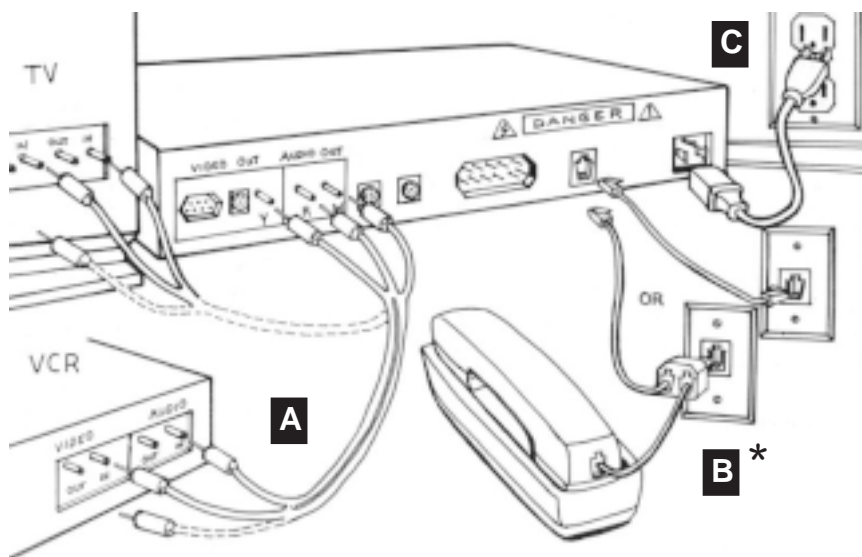

If you have only one telephone wall jack, use the supplied T-splitter so the unit and the phone can share the same line. When the unit is active, an individual calling you will receive a busy signal. If you have Call Waiting, the unit will be disconnected from the Internet and you can take the call in the normal manner. To reconnect to the Internet following the phone call, press GO BACK on your keyboard. You will be re-connected to the Internet and returned to the page you were viewing when you received the phone call. Call Waiting can be disabled in the Options Menu (see page 37).

Connecting to a TV or VCR without Audio/Video Jacks

1. Set the channel switch on the RF modulator (not supplied) (Radio Shack cat. # 15-1283A) to VHF channel 3 or 4, whichever is not used or the least used in your area.
2. Connect the RF modulator to the Composite Video Output and Right/Left audio channel jacks on the unit.
3. Use an RF coaxial cable to connect the TO TV jack on the adapter to the ANTENNA IN jack on the back of your TV.
You may need to disconnect the antenna/cable from your TV to make this connection. Connect the antenna/cable to the ANTENNA IN jack on the RF modulator.
4. Connect one end of the telephone cable to the unit's telephone jack. Connect the other end to the telephone wall jack.
5. Connect the proper end of the AC power cord to the unit's power receptacle.
6. Set your TV to channel 3 or 4, as selected in step 1 above.

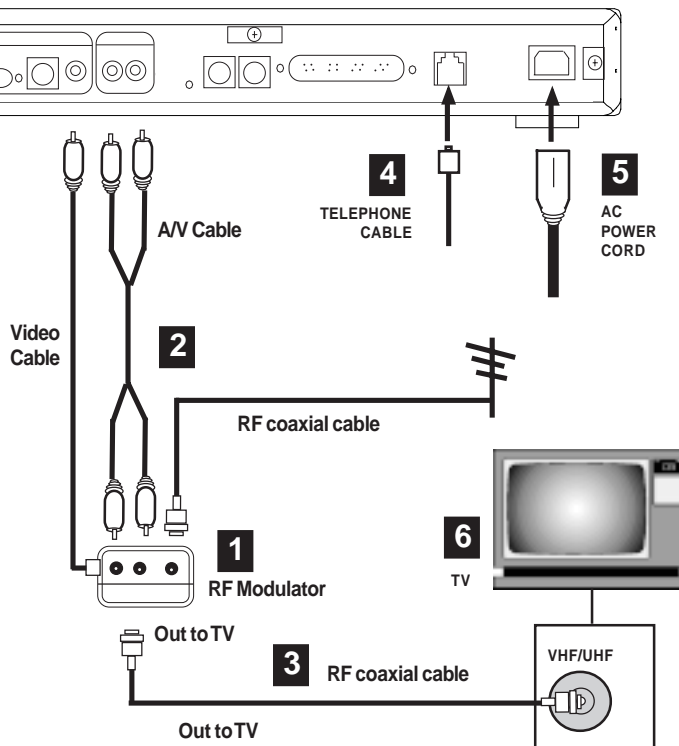

NOTE: If your television or TV remote has a TV/video button, push this button.

Connecting to a TV with an S-VIDEO Jack

NOTE: Connection to S-VIDEO may offer improved video display. To enhance audio performance, you may want to integrate the unit into your home entertainment system.

1. Use the supplied S-VIDEO cable to connect the S-VIDEO OUT jack on the unit to the S-VIDEO In jack on your TV.
2. Connect the Audio (right and left) jacks on the unit to your TV's AUDIO IN jacks, using the supplied audio cables.

NOTE: Do NOT connect the VIDEO cable (usually yellow) to the VIDEO jack when using the S-Video connection.

3. Connect one end of the telephone cable to the unit's telephone jack. Connect the other end to the telephone wall jack.
4. Connect the proper end of the AC power cord to the unit's power receptacle.

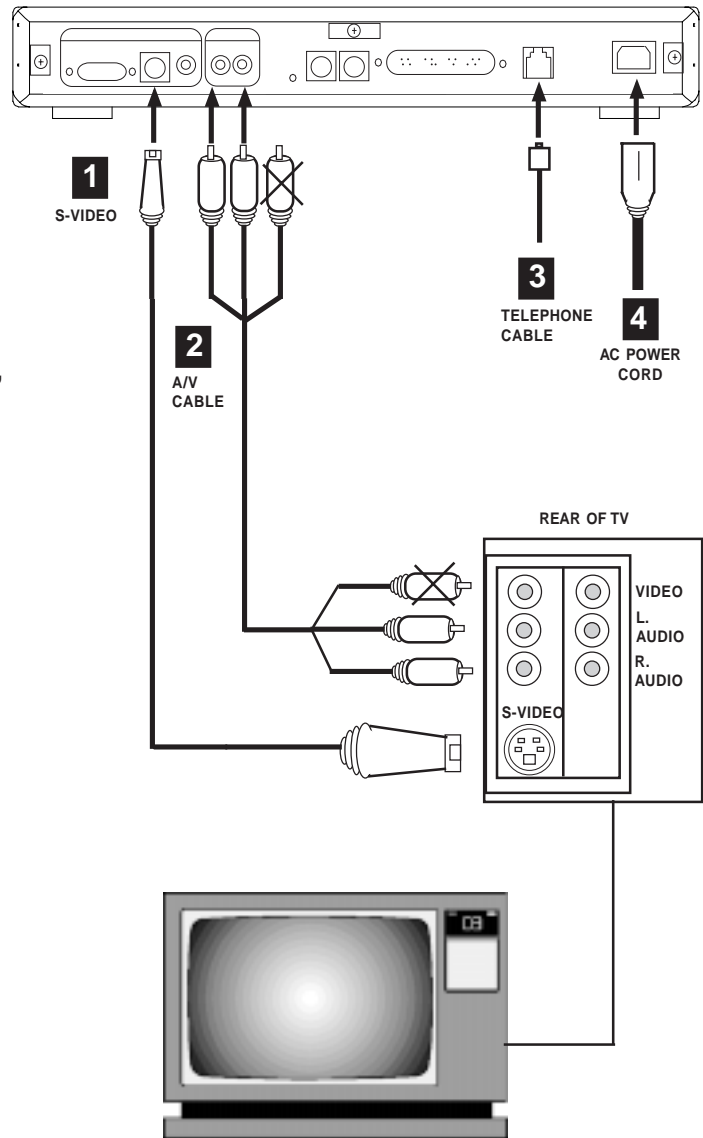

NOTE: If your television or TV remote has a TV/video button, push this button.

Connecting to a TV or VCR with Audio/Video Jacks

1. Connect one end of the supplied RCA-type A/V cable to the unit as identified and other end to the A/V IN jacks on your VCR or TV. Make sure you match colors. If there is only one audio jack, connect the white plugs.
2. Connect one end of the telephone cable to the unit's telephone jack. Connect the other end to the telephone wall jack.
3. Connect the proper end of the AC power cord to the unit's power receptacle.

NOTE: For step 4, you need either a coaxial cable (A), or an RCA-type A/V cable (B), but not both.

4. If connecting through your VCR, connect the VCR's A/V OUT jacks to the TV's A/V IN jacks. If using a coaxial cable for this connection, connect the coax OUT jack on your VCR to the coax VHF/UHF jack on your TV, using a coaxial connector cable (not supplied).

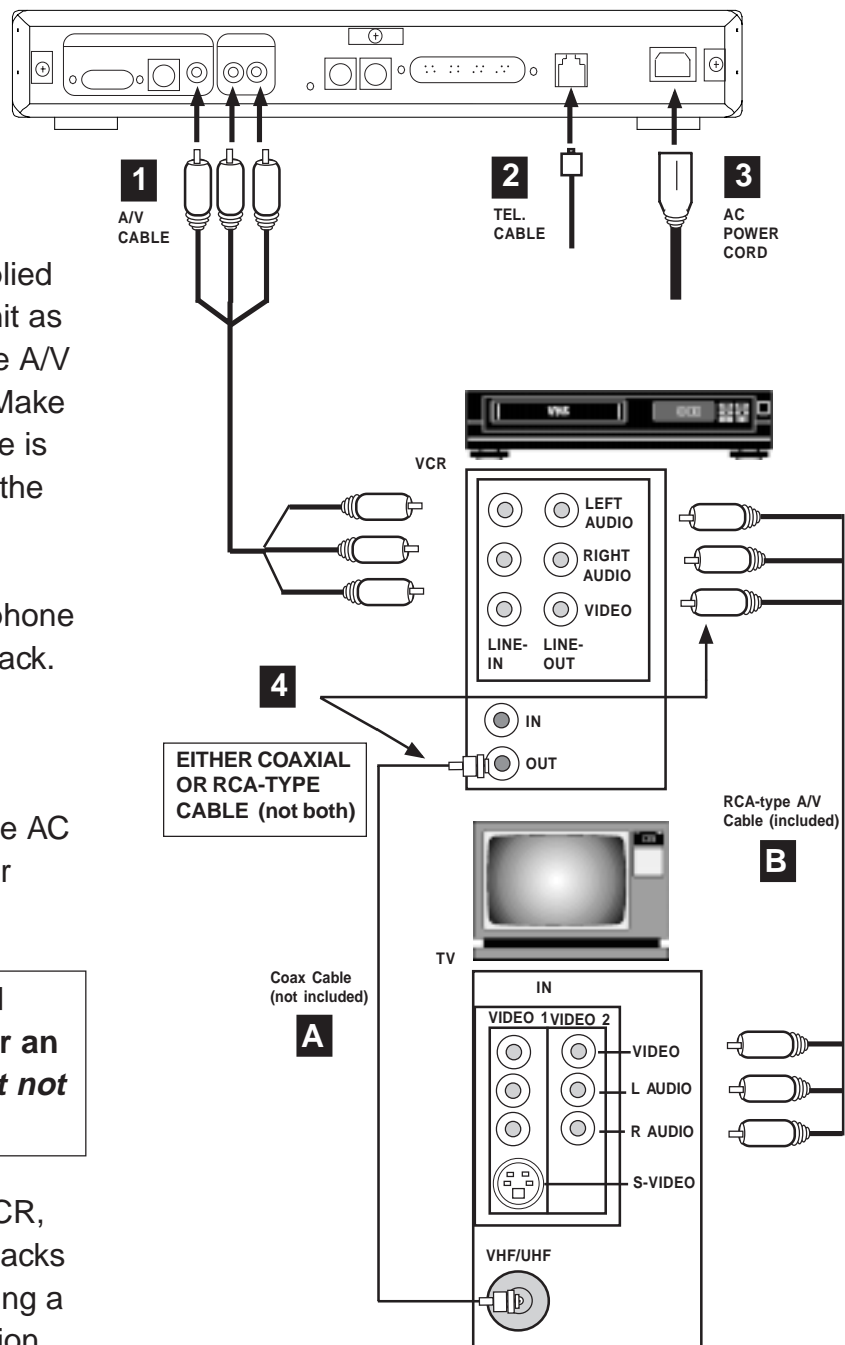

NOTE: If your television or TV remote has a TV/video button, push this button.

Connecting a Wireless Keyboard

Your wireless keyboard installation is fast and easy, as described below.

Inserting the batteries

1. Remove the battery compartment door.
2. Insert batteries (included) as shown in the diagram inside the battery compartment.
3. Replace the battery compartment door.

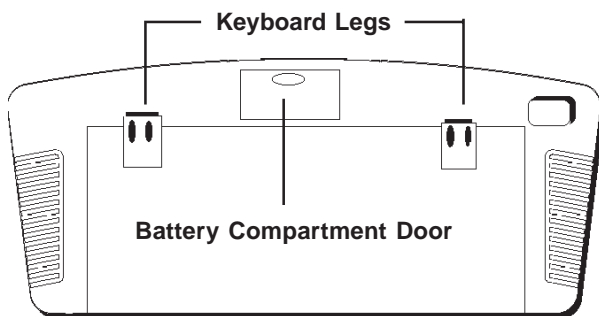

Adjusting the Keyboard Height

To raise the keyboard, lift up the keyboard legs until they snap into place. To lower the keyboard, push each leg down until it fits securely back into its cavity.

Pointing the Keyboard

The wireless keyboard should be used within 25 feet of the unit. For best results it should be pointed at no more than a 45° angle. The keyboard works on “line of sight”. If there are obstructions between the keyboard and the unit, or if the keyboard is tilted at too severe an angle, it may appear as if the keyboard isn’t working.

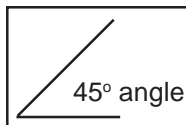

Keyboard Functions and Features

Arrows and ENTER / OK. Use the **arrows** to highlight items on the menu screens, and when surfing the web. Press **ENTER / OK** to select a highlighted item.

ALT. In ICA-application sessions, performs standard keyboard functions.

CLEAR/ESC. In ICA-application sessions, performs standard keyboard functions.

CTRL. In ICA-application sessions, performs standard keyboard functions.

FAV. Displays sites that are stored under ‘Favorites’ (when you are on-line).

FUNC. In combination with number keys, FUNC provides the equivalent function of pressing F1 to F10 on a PS/2-compatible keyboard.

GO BACK. Returns you to the preceding frame, web page, menu, or toolbar.

GO TO. Displays the URL Entry Toolbar so you can type in an URL to “go to” that web page.

GUIDE. Reserved for future applications.

HOME. Takes you back to the URL specified during setup.

INFO. Gives you web page details for a web site.

(continued on next page)

MAIL. Reserved for future applications.

MENU. Brings up the Main menu, or the Toolbar when you're surfing the web.

PAGE UP and PAGE DOWN. Scroll up and down through web content one page at a time.

POWER. Turns the unit on and turns it off (standby mode).

PRINT. Displays the Print Options box.

RELOAD. Reloads the current web page. If you are downloading a page, it stops the download

and loads the preceding page.

SAVE. Reserved for future applications.

SEARCH. Reserved for future applications.

SEND. Reserved for future applications.

Transport Keys (PAUSE, PLAY, STOP).

Controls Internet sound and movie player functions. STOP also stops loading a web page and stops printing. REV and FWD are reserved for future applications.

WHO. Reserved for future applications.

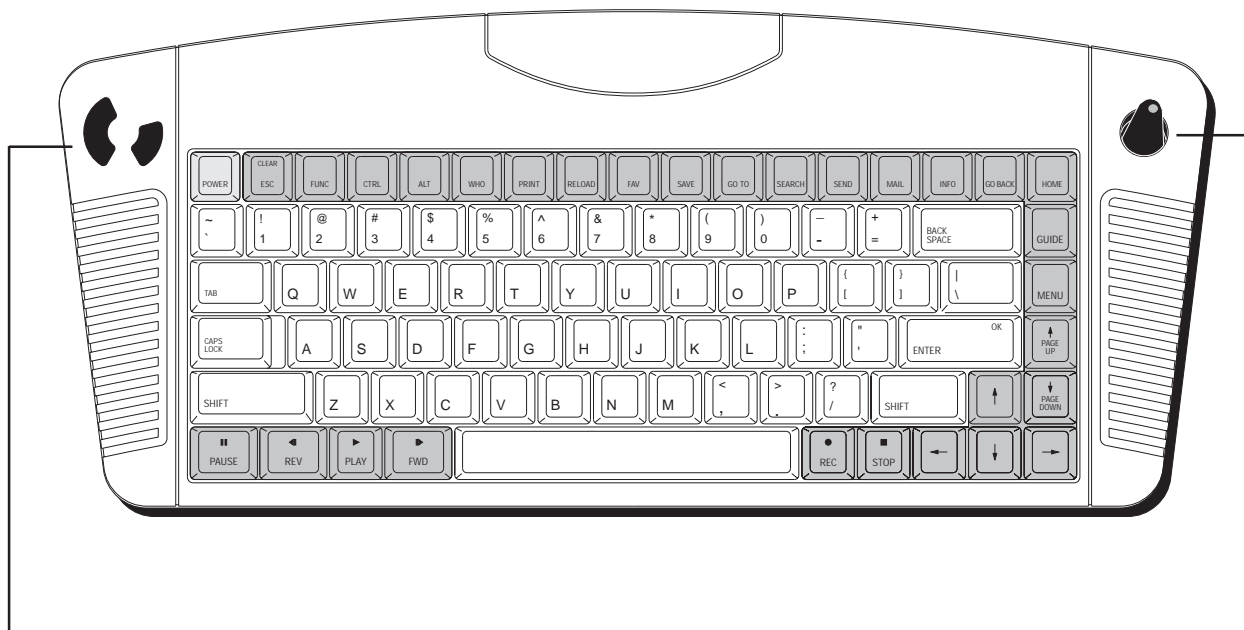

LEFT AND RIGHT MOUSE CONTROLS.

Use the left mouse control to select a highlighted item on menu screen or Internet. The right mouse control is reserved for future applications.

POINTER. Use to highlight items on menu screens and when you're surfing the web and when running software applications.

Connecting a Standard (Wired) PS/2 Compatible Keyboard

Using a PS/2-Compatible Keyboard

You can connect a PS/2-type keyboard to the unit. As with the wireless keyboard, you will be able to type information and responses into various text boxes which appear on the WEB pages.

Connect the keyboard to the keyboard port on the rear of the unit. The keyboard must have a 6-pin DIN connector. Note that the function keys on a personal computer keyboard respond differently once it is connected to the unit.

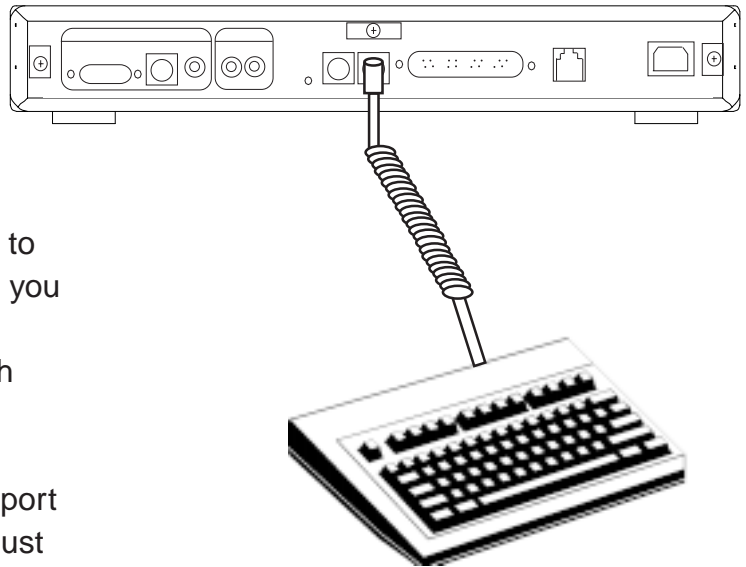

Connecting a Mouse

If you wish to attach a mouse, you will need a PS/2-type mouse (with DIN connector, not 9-pin serial connector).

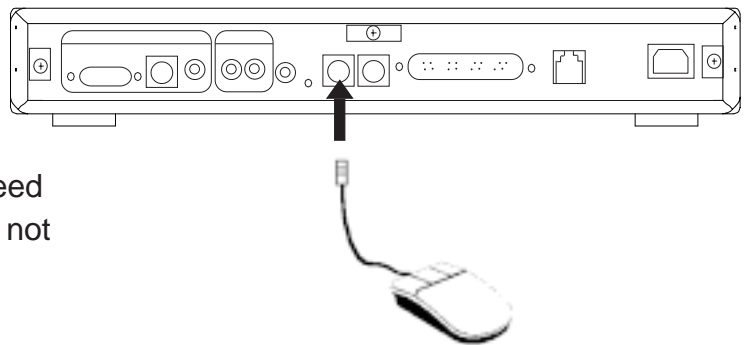

Connecting a Printer to the DB-25 Parallel Port

You will need a 25-pin to 25-pin parallel cable or the equivalent.

1. Connect the male end to the port labelled PRINTER on the unit.
2. Connect the other end to your printer.

NOTE: See page 36 for instructions on setting up your printer with the network software.

See page 43 for a list of compatible printers.

If your printer is not recognized when you enter the code for the particular model, try another code for the same brand, or try a different brand.

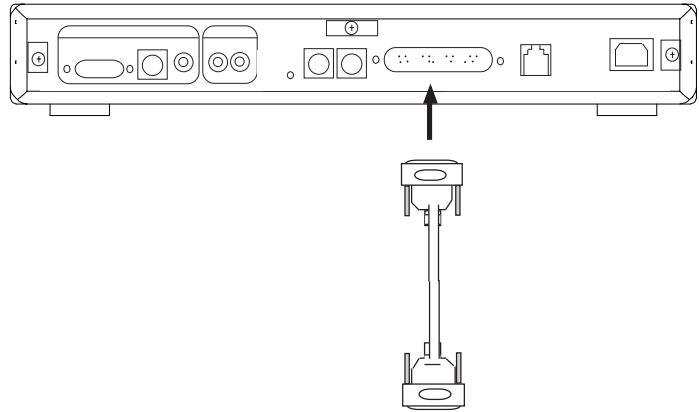

Connecting a VGA Monitor

If you wish to connect to a VGA monitor, connect the VGA monitor cable to the VGA port on the unit as shown.

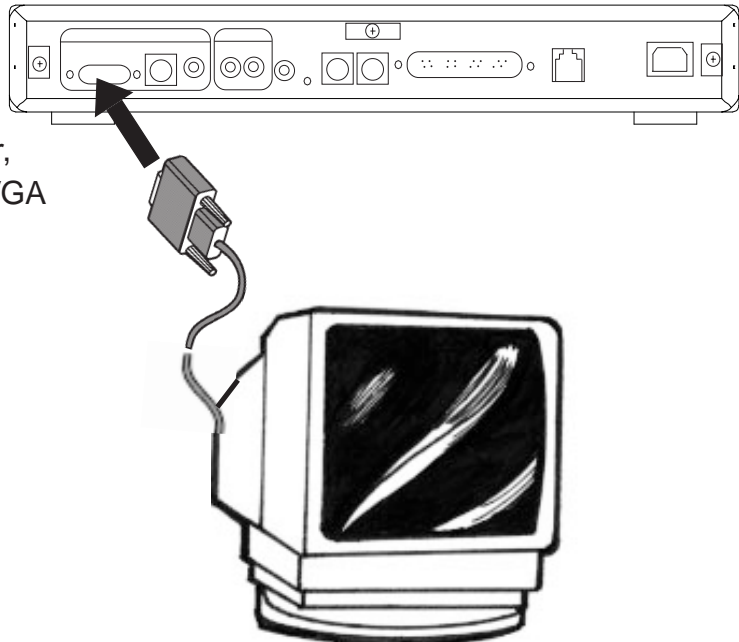

Specifications

Connectors—

- Internal 33.6Kbps Internet modem
- Smart card slot
- Parallel port allowing connection of printer to the unit
- Keyboard and Mouse ports.
- VGA Port.
- S-Video output.
- RCA composite video output.
- RCA right/left audio channels.
- Telephone jack.
- Power connector.

Power Requirements—

110-220V AC power supply

Accessories—

- Audio/Video cables
- S-Video cable
- Phone cable
- Telephone line splitter
- AC power cord
- Wireless keyboard
- AA batteries
- Owner's manual and EZ Setup guide
- Registration card
- Smart card

Dimensions—

Width: 11.75" (29.85cm)
Length: 10.125" (25.72cm)
Height: 1.625" (3.18cm)
Weight: 2.50lbs. (1.13kg)

Miscellaneous Specifications—

- Open ISP Architecture
- 8MB ROM
- 5MB DRAM
- ROM card slot
- Status LEDs:
 - Connect (RED);
 - Power (GREEN)

Network Software

Introduction

This portion of the owner's manual describes the interface for Internet access. Before you begin, please have the following information readily available:

- Your Internet Service Provider (ISP) local phone number
- Your User name (logon name)
- Your password (logon password)
- Your ISP Home Page (URL)
- Your ISP Domain name
- Your ISP primary and secondary DNS numbers

NOTE: If you are new to the Internet and do not have an established relationship with an Internet Service Provider (ISP), you will need to contact one for the adjacent information.

On-Screen Display

The Network screen display is capable of 640 x 480 pixel resolution. All actual interface elements reside within a safe area of 576 x 422 centered within the 640x480 screen. The safe area is 5%, on the left and right edges, and 6%, at the top and bottom edges.

Color Palette

The display will support a maximum of 256 colors.

Screen Saver

If the unit detects no input from you for a period of five minutes, the screen saver image is displayed. Any subsequent input removes the screen saver image. If there is no modem activity for a period of ten minutes, the phone connection is dropped.



Power Off Request

If you press the power button on the wireless (IR) keyboard once more, the following message appears:

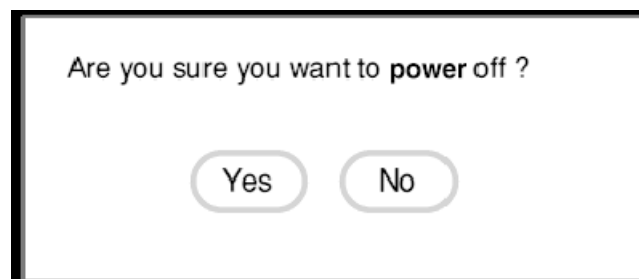

Choose **Yes** to place the unit into standby mode.

Choose **No** to close the power off screen

Smart card

Before powering the unit on, make sure the smart card is properly inserted (logo-side up) in the slot on the front. The card must be properly inserted for the unit to work.

1. Locate the smart card included in the documentation package. It should look similar to the illustration shown here.



NOTE: Actual appearance of card graphics may vary.

2. Insert the card with the logo-side up. Do not remove the card during any session unless instructed to do so.

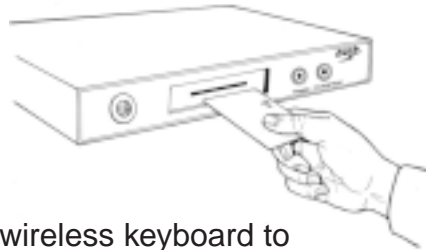

3. Press the Power button on the wireless keyboard to power on your unit. Or, press CTRL+ALT+DEL on a standard PS/2 keyboard

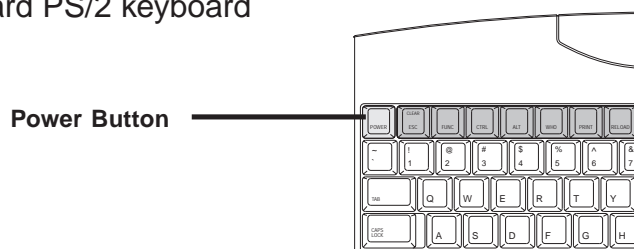

Start-up Sequence

This section describes the screens which are displayed when you first begin to access the Internet and attempt to connect to your Internet Service Provider (ISP).

Ready to Go Screen

This screen allows you to access the Welcome screen where you may set various options, configure your smart card, and connect to your ISP.

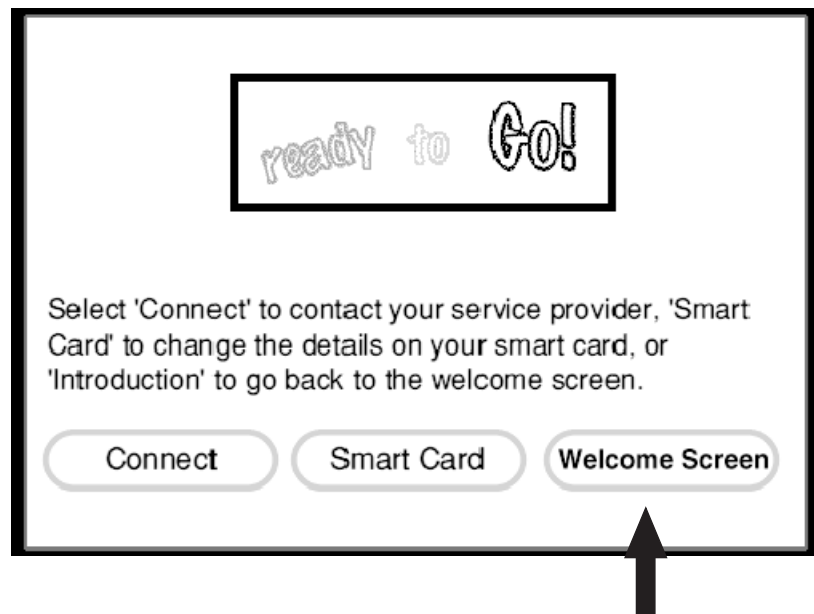

Welcome Screen

When you select the Welcome screen, the following appears.



Choose **Continue** to return to the **Ready to Go** screen.

Choose **Options** to display the main options screen (as described in Options section, pages 35-37). These options include settings for text size and scaling, setting up your printer, adjusting the display, turning sounds on and off, and dialing and call-waiting options.

Smart Card Screens

This section describes the smart card Setup screens that can appear when using a smart card. From the Ready to Go screen, select Smart Card. **If prompted for a PIN, enter '1234' to continue.**

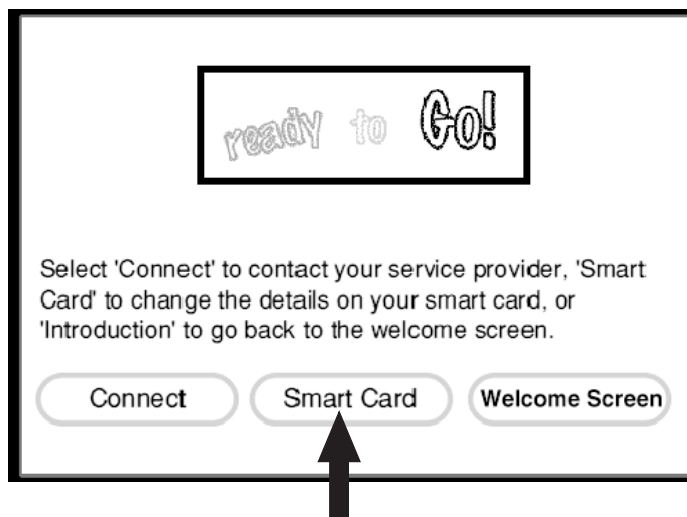

Begin Setup

This screen allows you to set up for the first time or change ISP (Internet Service Provider) and PIN (Personal Identification Number) information on your smart card.



NOTE:
Record your PIN
number here for
future reference.



Choose **Change ISP** to display the Change ISP details screen where you may input ISP account information. **IMPORTANT: A home URL must be entered** (ex. <http://www.bocaresearch.com>)

Examples of web-based Email sites: mailcity.com hotmail.com rocketmail.com yahooemail.com

Choose **Change PIN** to display the Change PIN screen (see next page) . This allows you to set up a Personal Identification Number (PIN) for access security. **DO NOT forget your PIN; if you do, the Smart Card will have to be replaced.**

Choose **Go Back** to return to the Ready to Go Screen.

Change ISP Details Screens

These two screens allow you to edit the ISP details stored on your smart card.

ISP Phone Number:	<input type="text"/>	REQUIRED
User Name:	<input type="text"/>	REQUIRED
Password:	<input type="text"/>	REQUIRED
Home URL:	<input type="text" value="http://www."/>	REQUIRED
Email URL:	<input type="text" value="http://www."/>	OPTIONAL

Next... Cancel

Choose **Next...** to save the details and then display the second smart card details screen.
Choose **Cancel** to return to the Ready to Go screen.

Please enter the dial-up information that is stored on your smart card:

ISP Domain Name:

Primary DNS:

Secondary DNS:

Modem dial script: *DO NOT CHANGE*

IMPORTANT: Do not change the Default Modem Dial Script. If you should erase it inadvertently, the full script is:

`
ATZ

OK
AT&C1&D1&K3W2

OK
ATDT

CONNECT

` and must be typed in exactly as shown here.

Choose **Confirm** to save the information and then display the Ready to Go screen.

Choose **Cancel** to return to the Ready to Go screen.

Change PIN

If you select the **Change PIN** option from the Begin Setup screen, the following message appears. **Make sure to record the PIN number entered.**

Please enter the following:

New PIN:

New PIN (again):

If you enter two different PINs, then the Invalid New PIN screen is displayed; otherwise you are returned to the Connect to Service screen.

Invalid New PIN

If you enter two different PINs on either the Change PIN screen or the Unblock PIN screen, then following message appears:

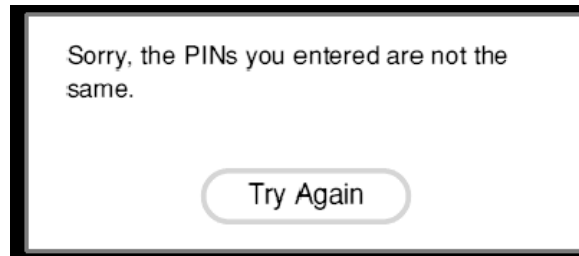

Clicking **Try Again** returns you to the previous screen.

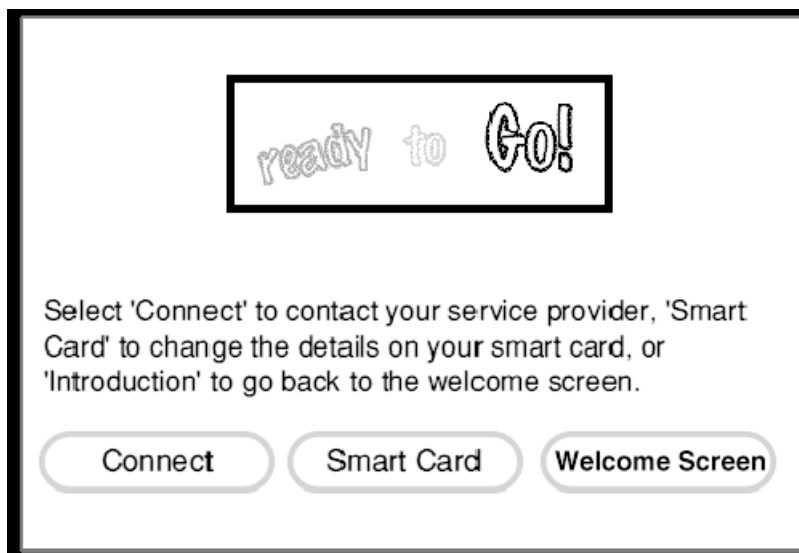

Check for smart card

Clicking 'Connect' on the Welcome screen checks for the presence of a valid smart card.

Smart card Not Inserted

On selecting the 'Connect' option on the Welcome Screen a check is made to see if a smart card is present in the unit. If not, the following screen appears.

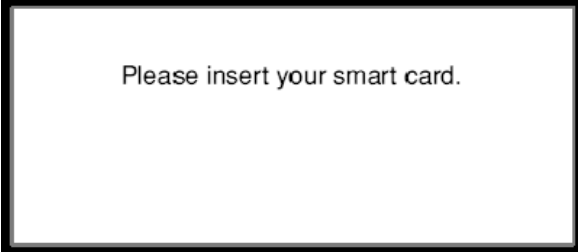

Please insert your smart card.

Smart card Not Valid

If the smart card is not authorized for use with unit, the following message appears.

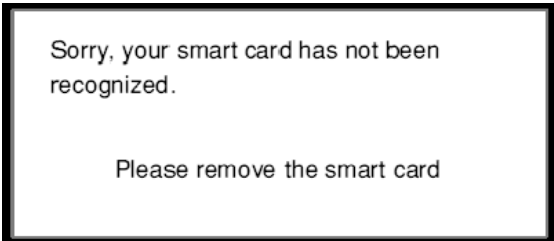

Sorry, your smart card has not been recognized.

Please remove the smart card

Removing the smart card returns you to the Welcome screen.

Smart card Damaged

If the smart card is authorized but is damaged, i.e., only part of the information on the card can be read, the following message appears.

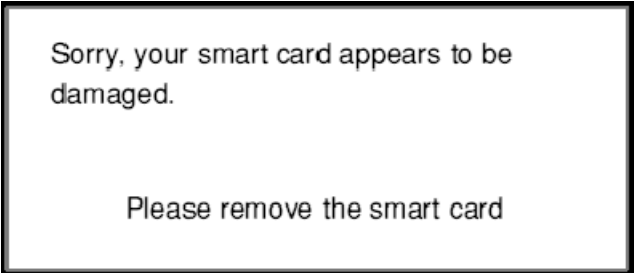

Sorry, your smart card appears to be damaged.

Please remove the smart card

Removing the smart card returns you to the Welcome screen

When a valid smart card is inserted, a check is made to see if the card is PIN protected.

Check for valid PIN

If the smart card is PIN protected you are asked to enter a valid PIN (see PIN Screens section).

PIN Screens

This section describes the PIN protection screens that can appear when using PIN protected cards.

Enter PIN

When you insert the smart card, a check is made to see if the card is PIN protected. If it is, then following screen appears. **Enter '1234' as the default PIN number.**

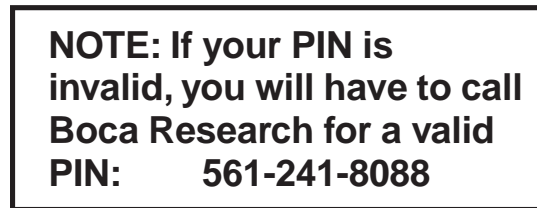
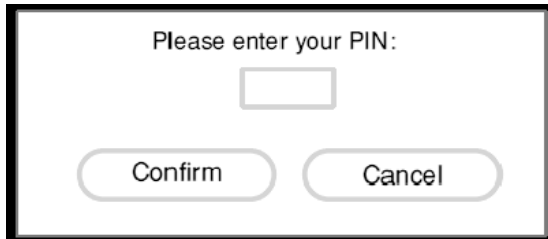

If you enter a correct PIN and click **Confirm**, then the Connect to Screen appears, otherwise the Invalid PIN screen appears. If you click **Cancel** the Welcome screen appears again.

Invalid PIN

If you enter the wrong PIN in the Enter PIN screen, the following message appears.

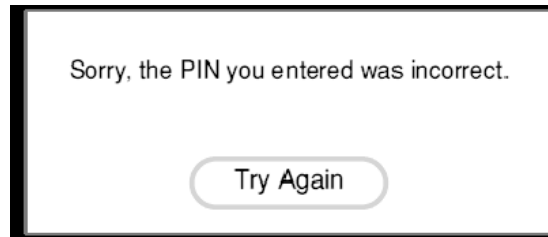

Clicking **Try Again** returns you to the Enter PIN screen.

If you enter an invalid PIN 16 times in a row, then the following screen appears.

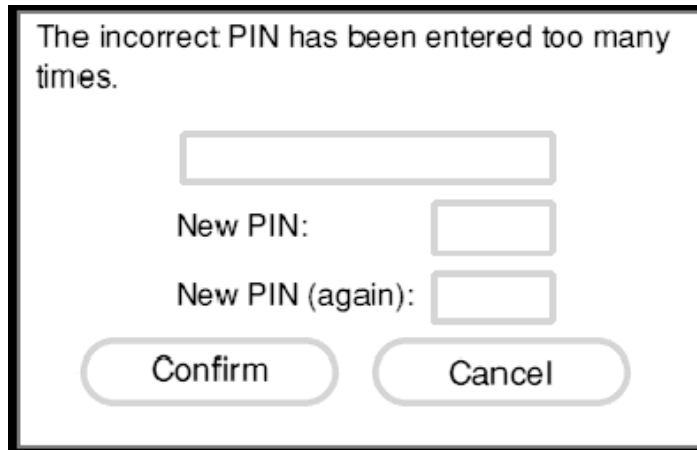

The incorrect PIN has been entered too many times.

New PIN:

New PIN (again):

If the smart card is not PIN protected or a correct PIN is entered then the Ready to Go screen will be displayed where you may choose Connect.

Choose **Connect** to start the dialing sequence.

Choose **Smart card** to display the change smart card details screen. (see smart card screen section, page 20-25).

Choose **Welcome Screen** to return to the Welcome Screen.

Dialing Sequence

Dialing to the ISP is now initiated. During this process the Dialing Screens will appear (see next page). After the system successfully connects, the ISP home page will be displayed and the Browser toolbar will appear.

Dialing Screens

This section describes modem status messages that appear during the connection to your ISP. This is either when you first connect to your ISP or when the line has been dropped due to modem inactivity and a reconnection is initiated.

Modem Status Screens

The modem activity screens appear as in the example below. The screen changes as the modem status changes.



There are three processes in connecting to the ISP and they are reflected in the text highlighted as follows **Dialing**, then **Connecting** and finally **Verifying**.

Modem Error Messages

If no dial tone is detected, the following message appears:

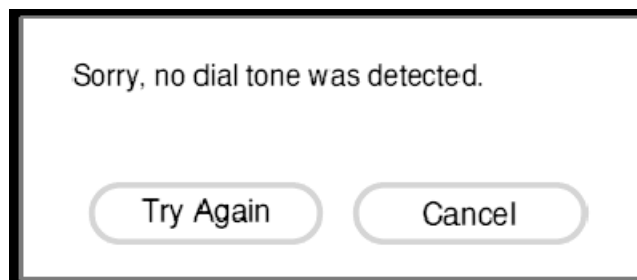

Check your telephone line connection, then
Choose **Try Again** to re-attempt the dialing process.
Choose **Cancel** to quit the dialing process.

If the line to the ISP is busy then the following message will appear:

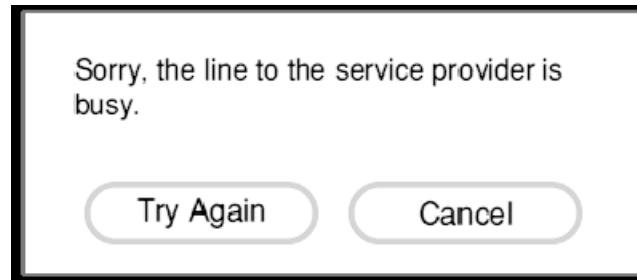

Choose **Try Again** to re-attempt the dialing process.

Choose **Cancel** to quit the dialing process.

If any other problem occurs while trying to connect to the ISP the following message will appear:

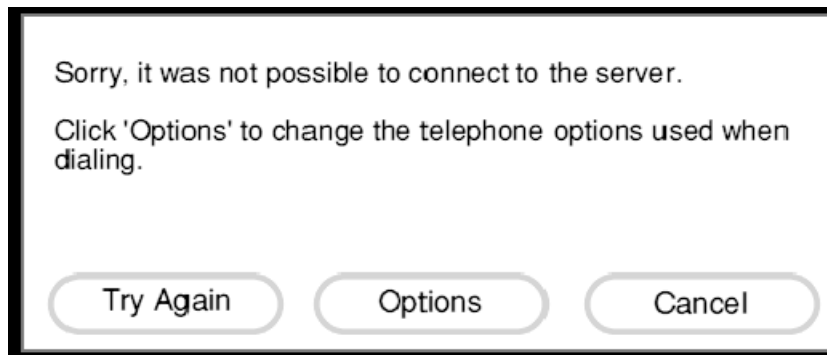

Choose **Try Again** to re-attempt the dialing process.

Choose **Options** to display the telephone options screen (as described in Options section)

Choose **Cancel** to quit the dialing process.

Browser User Interface

This section provides details of the Web Browser user interface.

Browser Toolbars

Main Toolbar

The main toolbar appears when you connect to the ISP. You can toggle the toolbar on and off by pressing the **Menu** button on the remote handset or keyboard.



- | | |
|---------------------------|---|
| Choose Home | To go to the home page specified during setup. |
| Choose Back | To go back to the previous web page in history list. |
| Choose Fwd | To go forward to the next web page in the history list. |
| Choose Go To | To display the URL Web page entry pop-up. |
| Choose Email | To go to the e-mail site specified during setup. |
| Choose More... | To display the secondary toolbar. |
| Use Up/Down Arrows | To page up and down the document. |
| Check Progress Indicator | This moves when the page is loading. If it is not moving selecting this reloads the page. |

Go To

The Go To pop-up appears above the main toolbar when you select **Goto** from the main toolbar. This toolbar allows you to enter a Web Page URL in a text entry field. The text entry field contains the default text <http://www>.



Choose the **URL Entry field** to enter a URL. Pressing OK on the remote or keyboard closes the pop-up and displays the web page requested.

Choose **Last** to insert the URL previously entered in the field.

Choose **Current** to insert the current URL into the field.

Secondary Toolbar

The secondary toolbar appears when you select **More...** from the Browser main toolbar



- | | |
|---------------------------|---|
| Choose History | To display the history page. |
| Choose Favs | To display the Favorites list. |
| Choose Save | To save the current page to the list of favorites. |
| Choose Options | To display the options pages. |
| Choose Print | To display the print pop-up screen. |
| Choose More... | To display the main toolbar. |
| Use Up/Down Arrows | To page up and down in the document. |
| Check Progress Indicator | This moves when the page is loading. If it is not moving selecting this reloads the page. |

History

The History page appears when you select **History** from the secondary toolbar. Two history lists are available. The first is the recent browser history list and the second is the alphabetical browser history list. The button in the top right corner of the page toggles between them.



Clicking on any of the titles in either list will cause the Browser to retrieve and then display the requested page.



Favorites

The Favorites page appears when you select **Favs** from the second toolbar.



Clicking on any of the titles in the list causes to the Browser to retrieve and then display the requested page. Clicking the **Delete Favorites** button displays the following page.



Check the boxes of the pages you wish to remove and then click the **Delete** button. Clicking the **Back to Favorites** button returns you to the Favorites List.

Options

The main options page appears when you select **Options** from the secondary toolbar. This page is described in detail in the Options section.

Print

The Print pop-up appears in the center of the screen when you select **Print** from the secondary toolbar or press print on the keyboard.

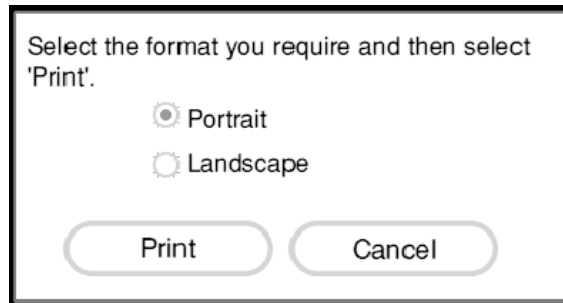

Clicking **Print** prints the page, while clicking **Cancel** closes the pop-up.

Print Frames

If the page you have requested to print contains frames then the following screen appears.

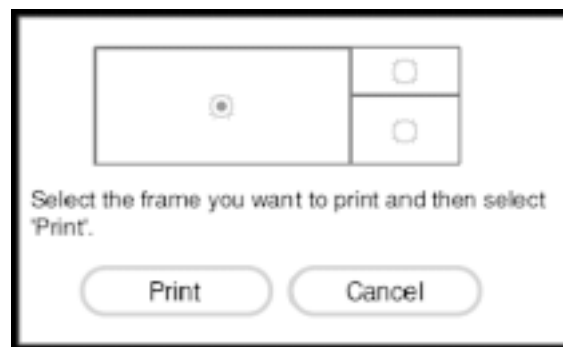

Chooses the frame you wish to print and then click **Print** to print the page. Alternatively clicking **Cancel** closes the pop-up screen.

Toolbar Buttons

Each of the toolbar buttons has two states: unhighlighted and highlighted.



Progress Indicator

While the indicator is moving, indicating that data is being transferred, you can stop the transfer by highlighting the indicator and pressing OK. If the indicator is not moving, highlighting it and pressing OK will reload the web page.

Up/Down Arrows

The up and down arrows allow you to scroll the web page a full screen at a time from the toolbar.



Web Page Links

On web pages the Browser highlights text and image links with a highlight rectangle.

Button Types

A number of standard button types are used by the Browser for displaying web pages containing forms.



Codec Controls

The codec controls appear above the current toolbar when you select a web link to a web resource requiring the controls.



Secure Socket Layer (SSL) Indicator

The appearance of the SSL icon indicates a secure connection. The icon appears above the up and down arrows on the toolbar.

Web Page Password Challenge

Some web pages, e.g., <http://www.timeout.co.uk/TO/Info/> require a password screen.

Enter your user name and password
for Time Out at www.timeout.co.uk *Example*

Name

Password

Image Map Cursor

When you highlight an image map and press OK to navigate over the map, the image map cursor appears.



Mouse Cursors

When you control the unit with a mouse, the following cursors are used.



From left to right: Standard mouse cursor, Page drag cursor, Reposition frame borders left/right, and Reposition frame borders up/down.

System Busy Indicator

The following series of animations are displayed when the system is working and is not accepting input.



Frame Navigation Graphics

The frame navigation controls appear embedded in the frame borders on HTML pages containing frames. They allow you to move between frames using the arrow keys and the OK key. Each arrow has a selected and unselected state.



Option Screens

The Options screen appears when you select **Options** from

- (1) the secondary toolbar.,
- (2) the Welcome Screen, or
- (3) Dial failed screen.

The option pages allow you to configure the system for your personal use.

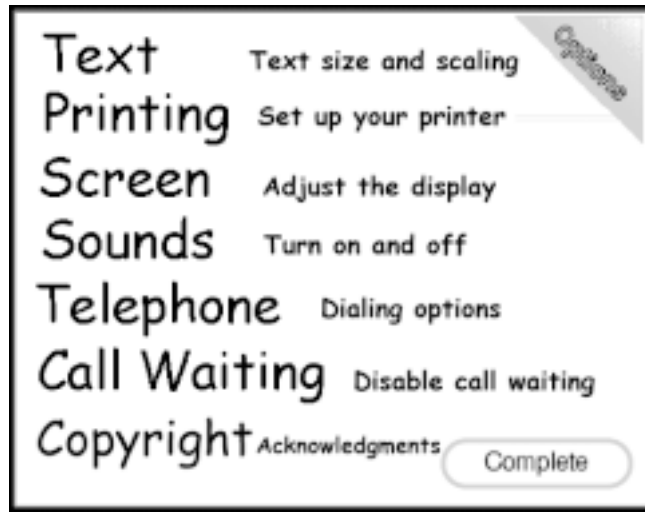

Text Options

This screen allows you to configure the text size and whether web pages should be horizontally scaled to fit the screen.

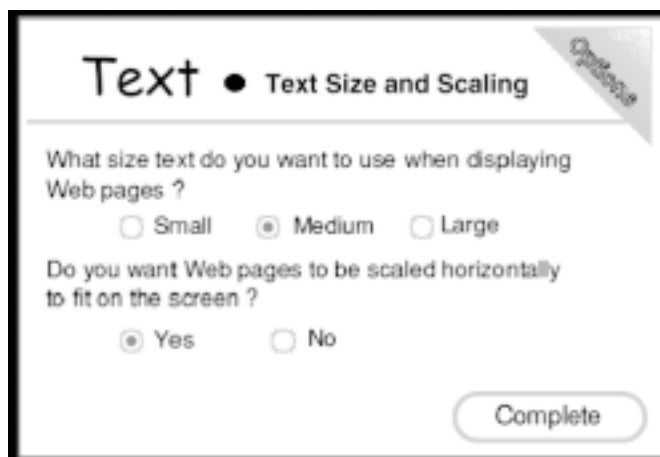

Printing Options

This screen allows you to configure the use of a printer (see codes on p. 43), choose whether you require color or black/white printing, and select the paper size you will use.

Printing ● Set up your printer

Please enter the three digit code that matches your type of printer from the list in your manual.

Do you require colour or black/white printing ?

Color Black/White

What paper size will you use ?

Letter Legal

Complete

Screen Positioning Options

This screen allows you to center the display on your television set.

Screen ● Adjust the display

Use the arrow buttons to position the screen so that it is centralized on your television screen.

↑
← ● →
↓

Complete

- | | |
|--------------------------------|--|
| Choose Arrows | To move the image in the direction of the arrow. |
| Choose Default (Circle) | To return the image location to the default setting. |
| Choose Complete | To return you to the main options page. |

Sound Options

This screen allows you to turn the sound effects and background music on / off.

Sounds ● Turn on and off

Do you want the NC to play sound effects ?

Yes No

Do you want the NC to play background music ?

Yes No

Complete

Telephone Options

This screen allows you to set up your dialing options, including pulse/tone dialing, obtaining an outside line, and waiting for the second dial tone.

Telephone ● Dialing options

Does your phone system use pulse or tone dialing ?

Tone Pulse

Does your phone system require you to enter a dialing prefix to obtain an outside line ?

No Yes - Prefix

Wait for a dial tone before dialing ?

Yes No

Complete

Call Waiting Options

This screen allows you to disable the call waiting feature of your phone system.

Call Waiting ● Disable call waiting

Does your phone system have call waiting?

Yes No

If it does then please enter the two-digit prefix to disable it.

Complete

ICA® Support

The BocaVision Network Device can now extend your network access to include Windows-based applications and data across the Web. By incorporating Citrix's ICA® Webclient for the Web, BocaVision provides remote users with access to business-critical applications residing centrally on a Citrix WinFrame or MetaFrame server.

Performance: Provides LAN-like application performance and responsiveness, even over low-bandwidth connections. "Thin client/server computing"¹ keeps vital information on the network and offers everyone access to the same centralized information. With ICA®, only screen updates, keystrokes and mouse-clicks travel the network—so applications run with blazing speed even over the smallest connections. Access Windows applications from any location. It doesn't matter whether the BocaVision Network Device is at headquarters, in a branch office, at home, in a hotel, airport or anywhere else.

¹Thin-client/server computing is an architecture where 100% of a program's application logic executes on the server. This form of computing provides an efficient, manageable and cost-effective method of distributing and managing applications across a broad-based network. See below.

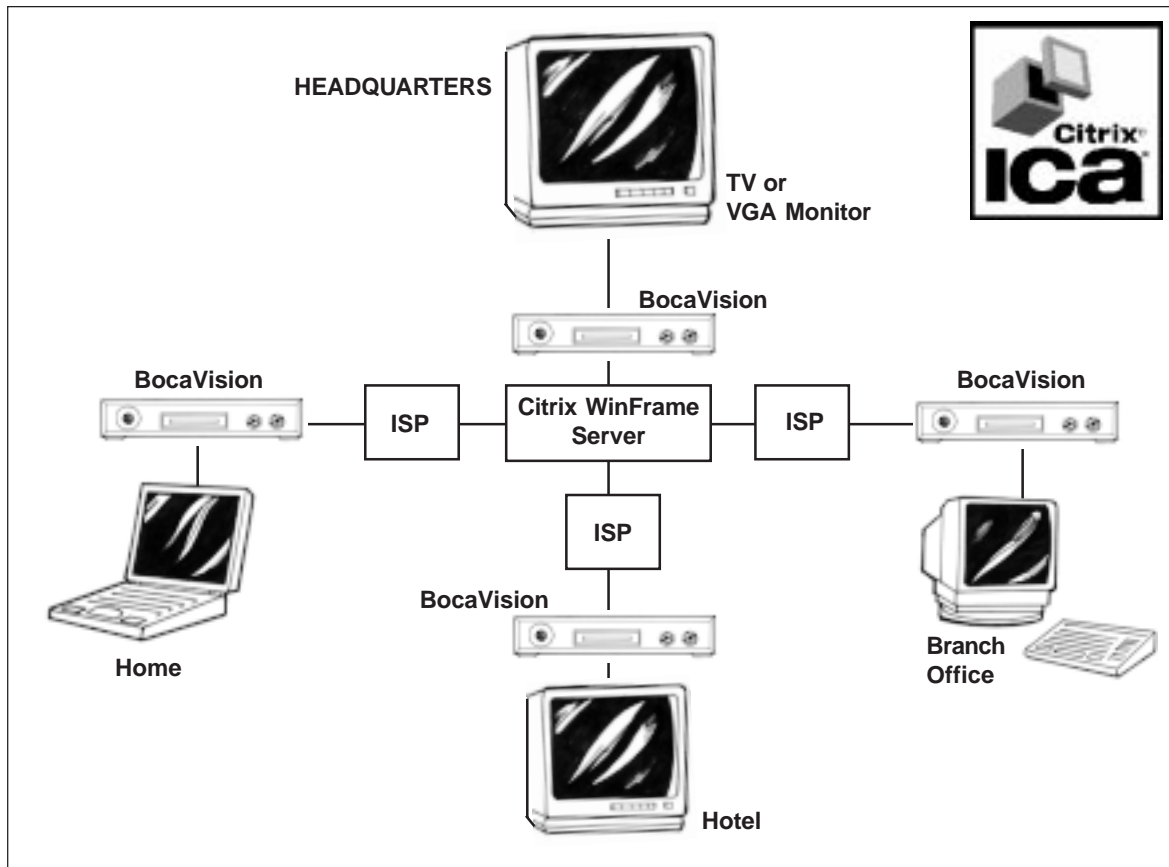

Launch with a URL

NOTE: Connection to a WinFrame server can only be established by dialing into an ISP first, or by dialing into an RAS server residing somewhere on the same network as the WinFrame server.

You may establish a direct ICA® connection using the BocaVision Network Software by first dialing into your ISP. Once connected with the Browser User Interface, select **Go To** from the **Main Toolbar**. The Go To pop-up appears. You may enter the URL in the proper format, as described following. Then select **Current**. (Or press ENTER or OK).



The format of the URL is as follows. Optional sections are within square brackets

ica://server name[/server description][?arg1[&arg2]...]

server name: A name or IP address of a server (the Address field of an ICA file).

server description: As listed in the ApplicationServers section of the AppSrv ini file.

argN: A name=value pair that can be used to set any of the allowed fields in the server section of an ICA file.

A special argument of PassClear can be used to pass in an unencrypted password.

The normal Password entry must be given as an encrypted password. This is most easily generated by a copy of the Remote Application Manager included in the Windows client.

The server name and the args both override the details in the AppSrv file. The server name takes precedence if an Address arg is given also.

Example: **ica:/Test%20Server?username=simon&password=00012jha987sdosd**

would use the connection details of the “Test Server” entry overridden with the given name and password. Note that the space character has to be escaped in the usual manner for URLs.

Example: `ica:?address=nc-nt` or `ica://nc-nt/`

would log on to the server whose name was nc-nt irrespective of what was in the AppSrv file.

Launch with ICA file

The most flexible way of starting a connection is with an ICA file. An ICA file is a text file that when fetched by the NC browser automatically starts up the ICA client and contains the details of what server to connect to and can be used to override default values.

Server configuration

The web server must be configured correctly to launch the client.

1. The file must have a **.ICA** extension
 2. The web server must be set up to send **.ICA** files with a mime type of ***application/x-ica***.
-

Troubleshooting

Problem	Suggested Solution
No screen display.	<ul style="list-style-type: none"> • Make sure the TV is set to the correct input channel (normally “3”). This is usually your Video, AV, AUX, L1, or L2.
Lost or damaged smart card. Forgotten PIN number.	<ul style="list-style-type: none"> • Call Boca Research Technical Support for assistance. (561-241-8088)
Connecting sequence fails.	<ul style="list-style-type: none"> • Make sure the phone line is connected to both the unit and a telephone outlet. • Make sure the smart card is properly inserted (logo-side up). • Make sure that an extension phone is not in use or the line will be busy. Call the local access number from an open phone and listen for modem connection. • Review the following options: <ol style="list-style-type: none"> 1. Make sure your prefix is valid and call waiting is enabled in the Options menu (see page 36). 2. Make sure you have a local phone number and all ISP information is accurately recorded (see p. 21).
Printer won't work	<ul style="list-style-type: none"> • Check the connection. • Did you set up the printer during setup? See page 36. • Make sure you have chosen a compatible printer code (see list of compatible printers on page 43).

Troubleshooting (contd)

Problem	Suggested Solution
<p>When using a TV to view a Windows application, the application's title bar and edges go off the screen.</p>	<p>When using a TV, the edges of the screen are lost due to the overscan mode used by BocaVision. To counteract this effect, the ICA client needs to be placed in underscan mode.</p> <p>Edit the *.ICA file for the application in question and add the following command to the section called out by the [Application Servers]. Example:</p> <pre>[WFCClient] version=2 TCPBrowserAddress=100.2.185.10 [Application Servers] RAS= [RAS] Address=100.2.185.10 . . . UseSafeArea=on (this is the command to add) . . .</pre>
<p>I get a message that reads "Unable to find www.xxx..."</p>	<p>Click on the Continue button that is part of this error box and then either:</p> <ul style="list-style-type: none"> • Click Connect, then Browse to type in a different URL. <p>OR</p> <ul style="list-style-type: none"> • Click on Smart Card to go offline and change URL details on the Smart Card

Printer Codes

Brother

HJ-100i	1
HJ-400	11
HL-10M	11
HL-10V	11
HL-1260	11
HL-630	11
HL-655M	11
HL-660	11
HL-730	11
HL-730X	11
HL-960	11
MFC 3900 ML	11
MFC 4000 ML	11
MFC 4500 ML	11
MFC 4550	11
MFC 5500 ML	11

Canon

BJ-100	1
BJ-10EX	1
BJ-105X	1
BJ-200	1
BJ-200E	1
BJ-200EX	1
BJ-230	1
BJ-30	1
BJ-300	1
BJ-330	1
BJC-210	1
BJC-240	1
BJC-250	2
BJC-4000	2
BJC-4100	2
BJC-4200	2
BJC-4300	2
BJC-4550	2
BJC-600	2
BJC-600E	2
BJC-620	2
BJC-70	2
LBP-1260	11
LBP-430	11
LBP45x	11
MultiPass 800	1
MultiPass 1000	1
MultiPass C2500	2

Citizen

Notebook Printer II	1
PN50 Notebook Printer	1
PN60 Notebook Printer	1
ProJet 3	1
ProJet 11	7
ProLaser 6000	11

Epson

ActionLaser II	11
ActionLaser 1000	11
ActionLaser 1100	11
ActionLaser 1400	11
ActionLaser 1500	11
ActionLaser 1600	11
EPL-5500	15
FX-185	4

FX-286	4
FX-80	3
FX-85	4
FX-86	4
GX-80	3
Stylus 800	5
Stylus 800+	5
Stylus 1000	5
Stylus Color 200	6
Stylus Color 300	6
Stylus Color 400	6
Stylus Color 500	6
Stylus Color 800	6
Stylus Color	6
Stylus Color II	6
Stylus Color IIS	6
Stylus Pro	6
Stylus Pro XL	6

HP

DeskJet 1200C	8
DeskJet 310	7
DeskJet 320	7
DeskJet 340	7
DeskJet 400	8
DeskJet 500	7
DeskJet 500C	8
DeskJet 510	7
DeskJet 540	8
DeskJet 550C	9
DeskJet 560C	9
DeskJet 600	7
DeskJet 600C	8
DeskJet 660C	9
DeskJet 660Cse	8
DeskJet 672C	9
DeskJet 680C	9
DeskJet 682C	9
DeskJet 693C	9
DeskJet 850C	9
DeskJet 855C	9
DeskJet 855Cse	8
DeskJet 855Cxi	8
DeskJet Pro	7
LaserJet 4	11
LaserJet 4L	11
LaserJet 4ML	11
LaserJet 4MP	11
LaserJet 4P	11
LaserJet 4Plus	11
LaserJet 5	11
LaserJet 5L	11
LaserJet 5MP	11
LaserJet 5P	11
LaserJet 6L	11
LaserJet 6P	11
LaserJet II	11
LaserJet III	11
LaserJet IIP Plus	11
OfficeJet	7
OfficeJet 300	7
OfficeJet 330	7
OfficeJet 350	7
OfficeJet LX	7
PaintJet	8
PaintJet XL300	10

IBM/Lexmark

4019 LaserPrinter E	11
4029-010 LaserPrinter	11
4029-020 LaserPrinter	11
4029-030 LaserPrinter	11
4037-SE	11
4039-10R LaserPrinter	11
4039-10 Plus	11
4039-12 Plus	11
4070IJ	1
4072 ExecJet	1
ExecJet II 4076	7
Color Jetprinter 1020BE	8
Color Jetprinter 3000	9
ExecJet IIC	8
Medley 4C	8
Medley 4sx	8
Medley 4X	8
Optra E	11
Optra Ep	11
Optra E+	11
Optra R	11
Optra RX	11
Valuewriter 300	11
Valuewriter 600	11
Winwriter 400	11
Winwriter 600	11

NEC

SilentWriter Model 1097	11
SilentWriter Model 95	11
SilentWriter Model 97fx	11
Superscript 610	11
Superscript 660	11

Okidata

Doc It 3000	11
Doc It 4000	11
OkiPage 16N	11
OL 1200	11
OL1200/PS	11
OL 400	11
OL 400E	11
OL 410E	11
OL 600E	11
OL 610E	11
OL 610E/PS	15
OL 800	11
OL 810	11
OL 810E	11
OL 810E/PS	11
OL 830 Plus	15
OL 850	15

Panasonic

KX-P4400 Sidewriter	11
KX-P4410	11
KX-P4430	11
KX-P4440	11
KX-P5400 Sidewriter	11
KX-P5410	15
KX-P6100	11
KX-P6500	11
KX-P5600	11

Accessories

- Wireless keyboard: Part no. 8600
- AA batteries Part no. 8264
- AC power cord: Part no. 8270
- Phone cable: Part no. 8508
- Audio/Video cable: Part no. 8507
- T-splitter: Part no. 8528
- S-Video Cable: Part no. 8532

To order these items, contact your distributor. For a list of local distributors, contact

Boca Research, Inc.
1601 Clint Moore Road
Boca Raton, Florida 33437-2841
(561) 241-8088

Limited Warranty

Boca Research, Inc. (BRI) warrants to the original buyer of this product that the hardware is free of defects in materials and workmanship for a period as follows:

- Up to 90 days: unit exchange or repair, including parts and labor.
- 91 days to one year: unit exchange or repair plus labor costs.

Should the product fail to be in working order at any time during the specified warranty period, BRI, will at its option, repair or replace this product as described below, provided that in BRI's sole determination the part or product has not been abused, misused, repaired, or modified.

All products will be serviced and returned via ground at no charge to customers.

All returns for limited warranty service require a Return Merchandise Authorization (RMA). All customers are required to demonstrate proof of purchase when requesting an RMA. The period of warranty commences on the date of purchase. A dated copy of the sales slip must be included with the returned merchandise.

Products which require Limited Warranty service during the warranty period should be delivered to BRI at the address in the *Servicing Your Product* section in this manual with proof of purchase, copy of canceled check (if any), and the Return Merchandise Authorization (RMA) number provided by BRI Technical Support. Replacement parts or complete products will be furnished on an exchange basis only. Replaced parts and/or products become the property of BRI.

If the returned product is sent by mail, the purchaser agrees to prepay shipping charges, insure the product or assume the risk of loss or damage which may occur in transit, and to use a shipping container equivalent to the original packaging. BRI does not make any warranties in respect to the product, either expressed or implied, including no implied warranties of merchantability or fitness for a particular purpose, except as expressly provided in this agreement. If any labor, repair, or parts replacement is required because of accident, negligence, misuse, theft, vandalism, fire, water or other peril; or because of conditions outside of specifications, including, but not limited to, electrical power, temperature, humidity or dust; or by moving,

repair relocation, or alteration not performed by BRI, or by any other cause other than normal use, the warranty and maintenance obligations provided herein shall not apply.

BRI SHALL NOT BE LIABLE FOR ANY SPECIAL, INCIDENTAL, OR CONSEQUENTIAL DAMAGES OR FOR LOSS, DAMAGE, OR EXPENSE DIRECTLY OR INDIRECTLY ARISING FROM CUSTOMER'S USE OF OR INABILITY TO USE THE EQUIPMENT EITHER SEPARATELY OR IN COMBINATION WITH OTHER EQUIPMENT, OR FOR PERSONAL INJURY OR LOSS OR DESTRUCTION OF OTHER PROPERTY, OR FROM ANY OTHER CAUSE.

Boca's products are manufactured from new and serviceable used parts tested to Boca Research's quality assurance standards. If the product proves to be defective, Boca Research will bear the costs of labor and materials for hardware replacement or repair during the above specified warranty period. Boca Research or its Authorized Service Providers shall have the option to replace any defective part(s) with new part(s) or, at the option of Boca Research, with serviceable used parts that are equivalent to new parts in performance. Boca Research shall also have the option to replace any defective product(s) with functionally equivalent product(s)

This warranty shall not be applicable to the extent that any provision of this warranty is prohibited by any Federal, state, or municipal law which cannot be preempted. This warranty gives you specific legal rights, and you may also have other rights which vary from state to state.

Servicing your Product

If your product requires service, first contact the authorized dealer from whom you purchased the BocaVision unit. If the dealer is unable to assist you, and you must contact Boca Research, Inc., please follow the instructions below.

If the Troubleshooting section did not resolve your problem, you may call our technical support staff for assistance. If you haven't referred to the Troubleshooting sections, do so now.

NOTE: CALLING TECHNICAL SUPPORT WITHOUT COMPLETE AND ACCURATE INFORMATION CONCERNING YOUR PROBLEM MAY BE BOTH TIME-CONSUMING AND FRUSTRATING FOR YOU.

1. When calling Boca Research Technical Support, have the following information available:

- Model and serial number
- Model of TV to which product is being attached
- Model of VCR

2. Call our Technical Support Department between the hours of 8:00 a.m. and 6:30 p.m. EST Monday through Friday at (561) 241-8088. A technician will be available to discuss the problem(s) you are experiencing.

If factory service is required, you will be given a Return Merchandise Authorization (RMA) number. Please place this number on the outside of the package when you return the item(s) for service and reference it on any correspondence included in the package. Boca Research, Inc. will return any product which is not accompanied by an RMA number.

3. Refer to the Limited Warranty Statement on the previous page to determine if the product is covered under the Boca Research, Inc. Limited Warranty.

4. Certain parts will not be covered under the Boca Research, Inc. Limited Warranty. Dealer installed parts are warranted by the dealer. Parts which you have installed yourself are covered only by

the supplier's warranties. In these cases, Boca Research, Inc. can identify which parts are defective, but will not replace such parts until specific written authorization is received from you. The cost of parts and labor involved in making such repairs will be billed to you C.O.D.

5. When sending the product to Boca Research, Inc. for repairs, please be sure to include:

- the BocaVision product
- your name
- your return street address (for UPS purposes)
- phone number
- the RMA number mentioned above

Package the product securely in a container equivalent to the original packaging, and insure the package to protect against loss or damage during transit. Shipping charges must be prepaid; C.O.D. shipments will not be accepted. Please use the address below for all correspondence:

Boca Research, Inc.
RMA Department - RMA # _____
6500 West Rogers Circle
Suite 3000
Boca Raton, FL 33487-2841

NOTE ON INTERNATIONAL SHIPMENTS:

Customer is responsible for all charges associated with shipping product directly to Boca Research's facility. This includes but is not limited to freight charges, customs charges, freight forwarding fees, storage fees, handling fees, documentation fees, duties, taxes, port charges, etc. Boca Research will NOT pay charges on freight which is not correctly routed directly to Boca Research's facility.

6. If the repairs performed on your modem were covered by the warranty, Boca Research, Inc. will return it prepaid via UPS.

How to get Technical Assistance

The dealer that you purchased this product from is the first place you should go for technical assistance. The dealer is usually the most qualified source of help, and is most familiar with your TV and how this product should be installed. Many dealers have customer service and technical support programs, with varying levels of support offered, depending on your needs and consumer electronic knowledge. **Please contact your dealer first whenever a problem occurs.**

If your Dealer Can't Assist you

If for some reason you are unable to return the product directly to its place of purchase, refer to "Servicing Your Product" on the previous page, or contact us as described here.



Standard Free Technical Support
561-241-8088

For quick answers to technical questions or issues, available M-F 8am-6:30pm (EST).



Priority Service
900-555-4900
(\$2 per minute)

For customers who need immediate access to senior-level technicians.



Boca BBS
561-241-1601

Provides 24-hour a day access to updated drivers and technical notes. Settings are N,8,1 and all speed modems up to 33.6Kbps are supported.



Technical Support Fax
561-997-2163

Fax in detailed questions and ask for solutions to specific installation problems.



Automated Fax
Retrieval 561-995-9456

Provides you with free access to technical documents, installation and configuration tips, and answers to most commonly asked questions.

Copyright

©1998. Boca Research, Inc. All rights reserved. No reproduction of this document in any form is allowed without permission in writing from Boca Research, Inc. Boca Research is not liable for any damages resulting from technical or editorial errors or omissions contained in this document. The information in this manual is subject to change without notice. Revisions to the product(s) in this manual may occur at any time without notice.

Trademarks

All Boca Research products are trademarks of Boca Research, Inc. All other references to computer systems, software, and peripherals use trademarks owned by their respective manufacturers.

Publication Date: July, 1998

Printed in the U.S.A.

9337.P65

On-Line Support!



CompuServe
GO BOCA

Internet: email:

support@bocaresearch.com

on the World Wide Web:

http://www.bocaresearch.com





Manual Part # 9337-01
07/98