

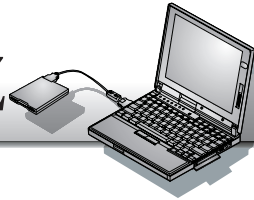

ThinkPad 560Z



Setup Guide

27L2615

This guide provides information for setting up your computer for the first time.

Front View (with external diskette drive)

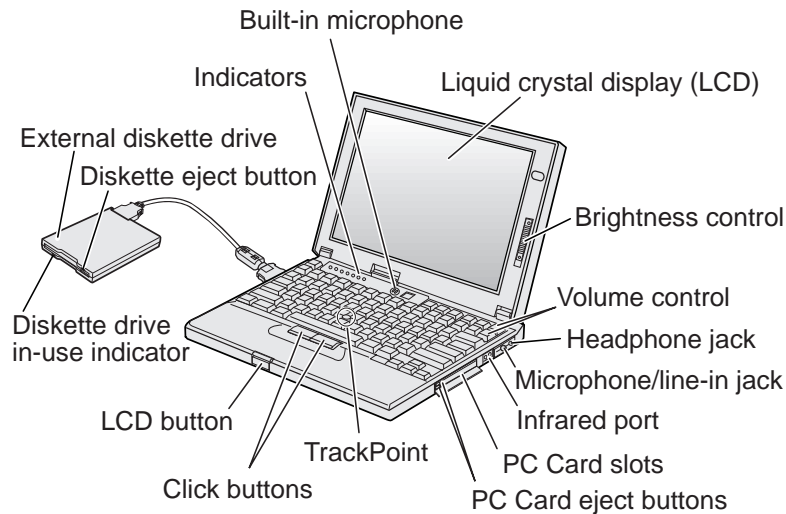

Rear View

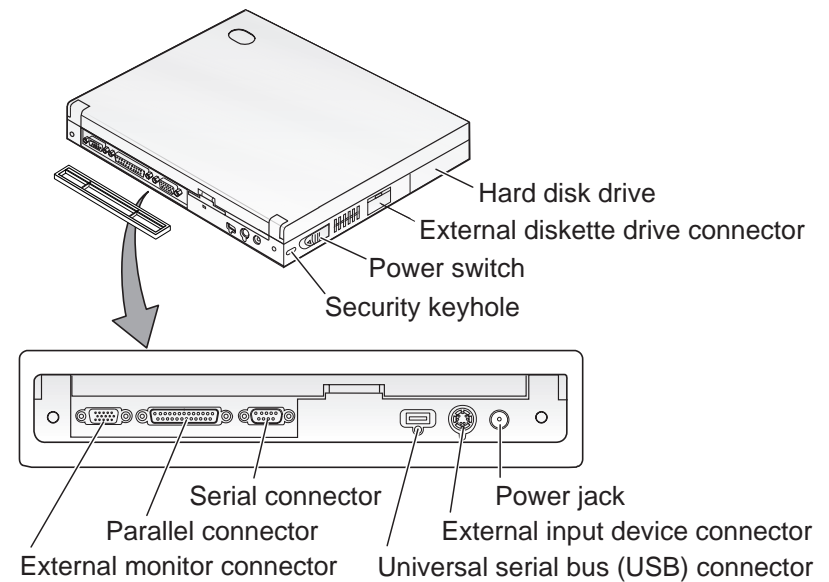

Electrical Safety

DANGER

Electrical current from power, telephone, and communication cable is hazardous. To avoid shock hazard, connect and disconnect cables as shown below when installing, moving, or opening the covers of the product or attached devices. The 3-pin power cord must be used with a proper outlet.

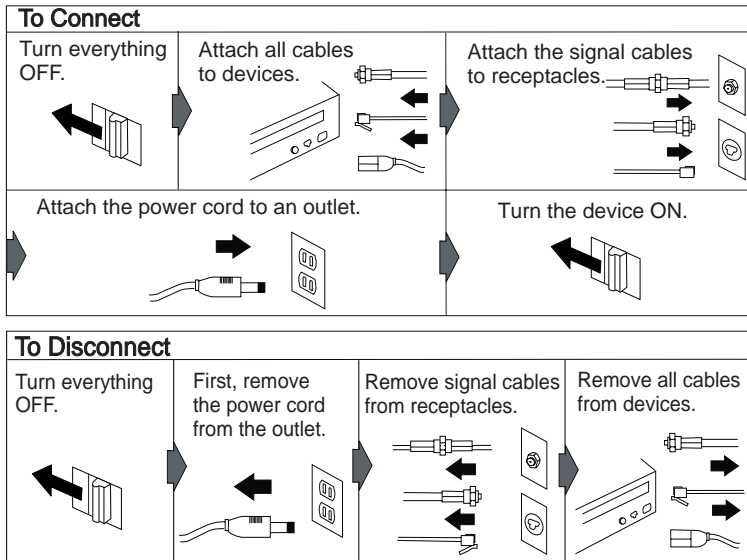

Note: In the U.K., by law:

The telephone line cable must be connected after the power cord.

The power cord must be disconnected after the telephone line cable.

Using the TrackPoint

The TrackPoint is a unique device for moving the cursor on the screen. You can perform all mouse operations with the TrackPoint. The left and right buttons function like the left and right buttons on a mouse.

To move the cursor, use the red-topped stick at the center of the keyboard. Press gently with your left or right index finger in the direction you want to move the cursor. To select and drag an object, press and hold one of the buttons with either thumb as required by your software.

Click means to press the left button once. **Double-click** means to press the left button twice within 1 second.

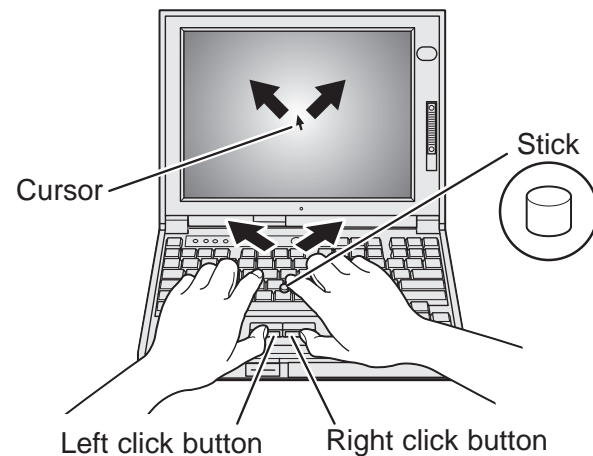

For more information about the TrackPoint, see the *User's Reference*.

Setting Up Your Computer

You are now ready to assemble and start your computer.

1 Connect the external diskette drive.

- a) Open the cover on the external diskette drive connector.
- b) Attach the cable to the external diskette drive, and then to the external diskette drive connector on the side of the computer. Press the sides of the connector 1 as you connect it to the devices 2.

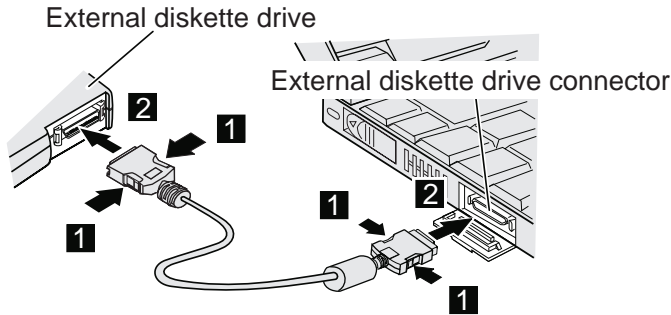

- ## 2
- If you want to connect a printer to your computer, open the connector cover. Connect one end of the printer cable to the parallel connector and the other end to your printer. Then power on the printer.

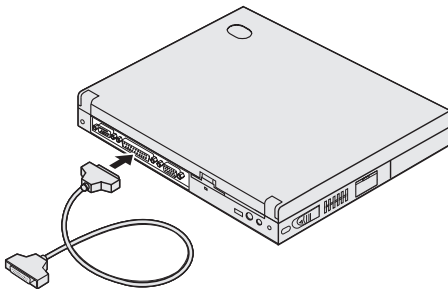

- ## 3
- Connect the AC Adapter to the computer's power jack (at the rear of the computer) in the order shown.

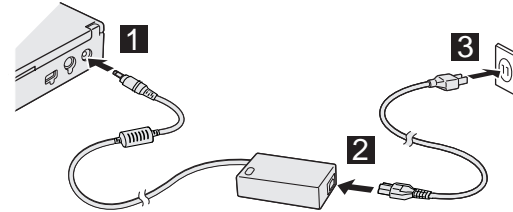

- ## 4
- Open the liquid crystal display (LCD).

Press the LCD button 1 and open the LCD 2. Then position the LCD so that it is convenient for viewing.

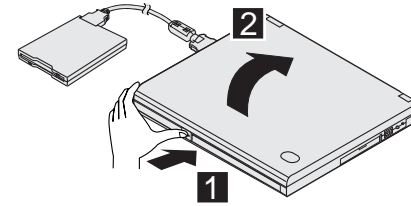

- ## 5
- Power on the computer.

- a) Push and release the power switch 1. The power switch automatically snaps back to its original position.
- b) Adjust the brightness of the display with the brightness control 2.

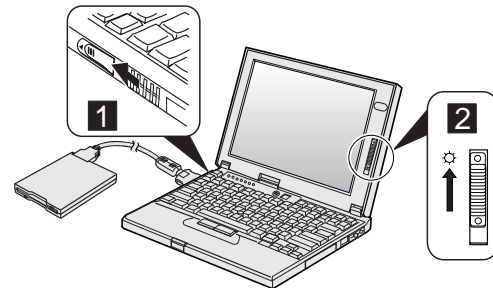

Note: To power off the computer without shutting it down, hold the power switch at least 1.5 seconds.

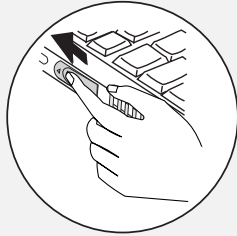

Customizing Your Computer for Windows 98

After you complete the Windows 98 setup by following the instructions on the screen, the **ThinkPad Customization Center** icon is on your Windows 98 desktop. To help you customize your computer for your specific needs, we have provided a collection of setup wizards known as *ThinkPad Customization Center*.

To start the ThinkPad Customization Center, double-click on the **ThinkPad Customization Center** icon. The ThinkPad Customization Center is launched into the browser, Internet Explorer (Version 4.0 or later). Follow the instructions on the screen.

Registering Your Computer

After setting up your computer, take a few moments to complete the ThinkPad registration. The information you provide will help IBM to serve you better in the future.

To register from the Windows 98 or Windows NT desktop, do the following:

- 1** Double-click on **Register**.
- 2** Follow the instructions on the screen to complete the registration.

(If you want to register your computer later, follow the same procedure.)

If your computer uses another operating system, go to the following Web site to complete registration:

<http://www.pc.ibm.com/register>

Getting More Information

If you want to learn more about your computer and its options, see the following:

ThinkPad 560Z User's Reference	Online User's Guide
<ul style="list-style-type: none">Getting familiar with your computerExtending the features of your computerProtecting your computerSolving computer problemsGetting serviceFeatures and specifications	<ul style="list-style-type: none">Using your computer outside your home countryUsing the audio featureUsing your computer with a battery packUsing your computer with a PC CardFrequently asked questionsInstalling softwareUsing system managementUsing PS2 commands
<p>Note: To start the <i>Online User's Guide</i>, click on Start and move the cursor to Programs and ThinkPad 560; then click on ThinkPad 560 User's Guide.</p>	