

Note

Before using this information and the product it supports, be sure to read the general information under Notices on page E-1.

First Edition (August 1997)

This publication could include technical inaccuracies or typographical errors. Changes are periodically made to the information herein; these changes will be incorporated in new editions of the publication. IBM may make improvements or changes in the products or the programs described in this publication at any time.

It is possible that this publication may contain reference to, or information about, IBM products (machines and programs), programming, or services that are not announced in your country. Such references or information must not be construed to mean that IBM intends to announce such IBM products, programming, or services in your country.

Requests for technical information about IBM products should be made to your IBM Authorized Dealer or your IBM Marketing Representative.

No part of this publication may be reproduced or distributed in any form or by any means without prior permission in writing from the International Business Corporation.

© Copyright International Business Machines Corporation 1997. All rights reserved.

Thank You for Selecting an IBM ThinkPad 310E or 310ED Computer

The IBM ThinkPad 310E or 310ED computer
is designed to be convenient for
your mobile computing needs.

We hope you enjoy its fast processing power,
brilliant and colorful DSTN or TFT LCD display,
and multimedia capabilities.

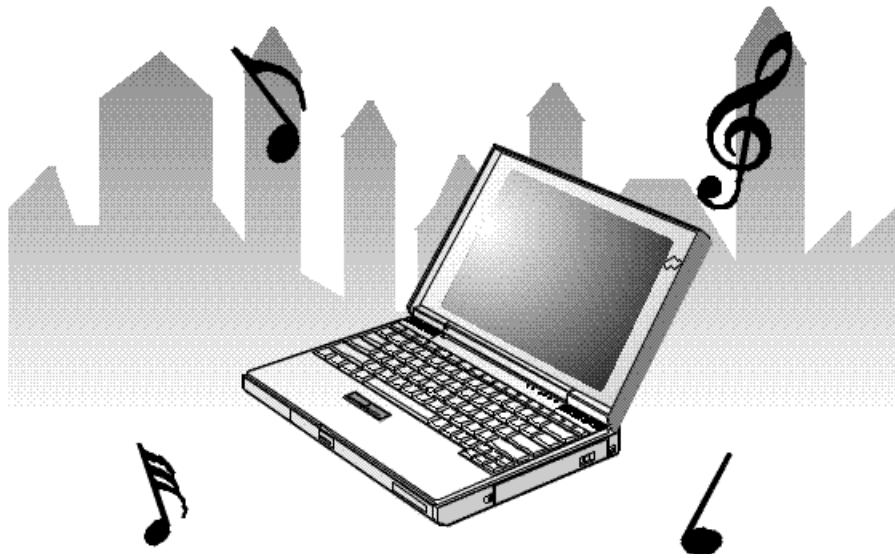

Distinctive System Features

Note:

Not all models support all the features shown here.

The following are the distinctive system features of the IBM ThinkPad 310E or 310ED computer:

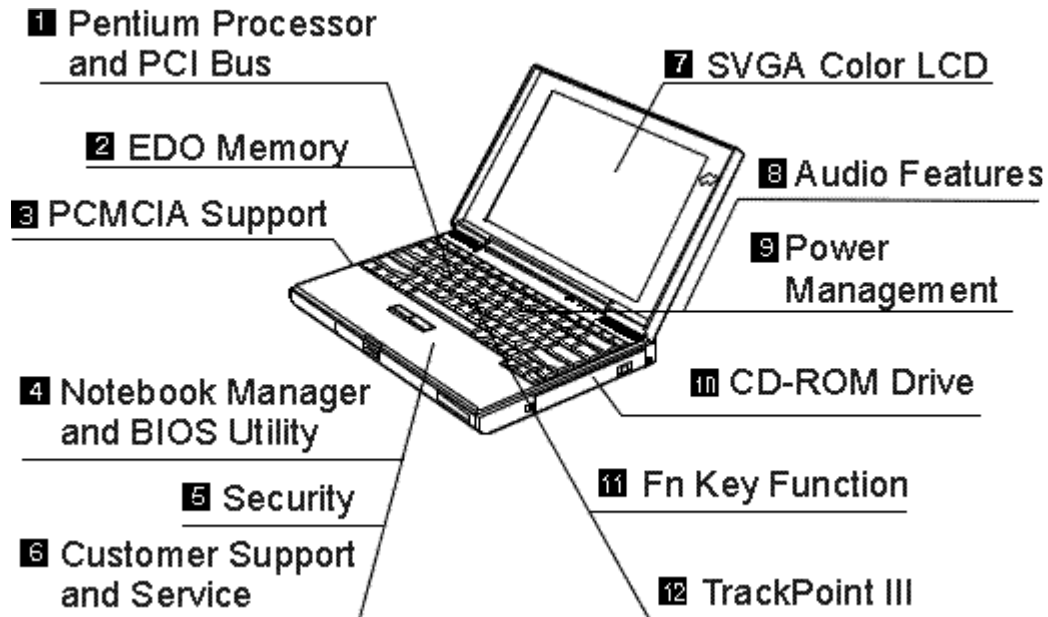

1 Pentium Processor and PCI Bus.

The fast Intel** Pentium** processor with MMX** technology and PCI bus combine to give your computer optimal speed and performance.

2 EDO Memory.

The built-in extended data out (EDO) memory chip enhances performance with fast memory access.

3 PCMCIA Support:**  Page 3-18.

The computer provides two Personal Computer Memory Card International Association (PCMCIA) slots. PCMCIA software also is provided so that you can use PC Cards more easily and conveniently.

4 Notebook Manager:  Page 3-3.

The Notebook Manager program allows you to set various parameters by using a graphical user interface.

BIOS Utility:  Page C-1.

The built-in BIOS Utility let you configure hardware settings for your computer.

5 Security:  Page 5-1.

The computer provides security passwords for the computer. Locking capability is provided for the computer. Personalization is also provided to make it easy to identify your computer.

6 Customer Support and Service:  Page 8-13.

Comprehensive service and support packages for your IBM ThinkPad 310E or 310ED computer are available in most countries.

7 SVGA Color LCD:  Page 3-13.

The DSTN (dual-scan super-twisted nematic) display models offer 256 colors at 800-by-600 SVGA resolution. The TFT (thin-film transistor) display models offer 65,536 colors at 800-by-600 resolution.

8 Audio Features:  Page 3-20.

The system-integrated Yamaha** Sound Chip provides stereo business audio (8 bit to 16 bit) with Sound Blaster** Pro compatibility.

9 Power Management:  Page 4-12.

Power Management sets the computer to different modes to save battery power when you are not using the full power of your computer. It also provides a resume function, which quickly returns you to where you left off.

10 CD-ROM Drive:  Page 3-22.

The built-in CD-ROM model affords access to large databases and multimedia applications. It can even play your favorite music CDs.

11 Fn Key Functions:  Page 2-13.

The combination of this Fn key with a function key is used to control display modes and battery power-saving modes.

12 TrackPoint III:  Page 2-10.

Pointing and selecting all become part of a single process with no need to lift your hands from the keyboard with the TrackPoint III.

About This Book

Note:

The illustrations in this book may be slightly different from your computer.

Be sure to read Chapter 1 and Chapter 2 before using the computer.

Read the following chapters whenever you need to.

This book contains information that will help you operate the IBM ThinkPad 310E or 310ED computer (hereafter called the *310E*, *310ED*, or *computer*).

Chapter 1, “Getting Started,” provides information about how to set up your computer.

Chapter 2, “Getting Familiar with Your Computer,” acquaints you with the basic features of your computer.

Chapter 3, “Operating Your Computer,” provides information on using your computer’s different features.

Chapter 4, “Using Battery Power,” provides power management information and describes how to operate your computer with the battery pack.

Chapter 5, “Protecting Your Computer,” provides information for protecting your computer and internal devices.

Chapter 6, “Installing and Removing Options,” describes how to install or remove IBM options.

Chapter 7, “Installing Software,” provides procedures for installing operating systems and device drivers in your computer.

Chapter 8, “Solving Computer Problems,” describes what to do when you have a computer problem.

Appendix A, “Avoiding Hardware Conflicts,” lists some steps you can take to avoid problems when you add or remove options.

Appendix B, “Advanced Information for PC Cards,” provides additional information when using PC Cards.

Appendix C, “BIOS Utility,” describes how to use the BIOS utility.

Appendix D, “Features and Specifications,” describes the features and specifications associated with your computer.

Appendix E, “Product Warranties and Notices,” contains the warranty statements for your computer and notices for this book.

This book also includes a **glossary**, for the meaning of terms and acronyms used in this book, and an **index**.

Information Notices

This book contains notices that relate to specific information or text.

Note

Provides important hints, tips, guidance, or advice.

Attention

Indicates possible damage to programs, devices, system, or data. It appears next to the related instruction or situation in which possible damage could occur.



Caution

Indicates situations that are potentially hazardous to you. It appears in text before the instruction or situation that could be hazardous.

Danger

Indicates situations that are potentially lethal or extremely hazardous to you. It is indicated

by the symbol  and appears in text before the instruction or situation that could be dangerous.

Treatment of Icons

This book contains the following icons (symbols):

- For procedures or information unique to the operating system installed in your computer:



Information for IBM DOS users.



Information for Microsoft Windows Version 3.11 users.



Information for Microsoft Windows 95 users.

- For procedures or information unique to the computer model or type:



Information only for 310E models.



Information only for 310ED models.

- For information referred to:



Where to go for more information

Ergonomics Information

This is important information to read before using your ThinkPad computer in the virtual office.

Working in the Virtual Office may mean adapting to frequent changes in your environment. Following some simple “rules of the road” will make things easier and bring you the maximum benefits of your ThinkPad computer. Keeping in mind such basics as good lighting and proper seating, for example, can go a long way in helping you enhance your performance and achieve greater comfort wherever you are.

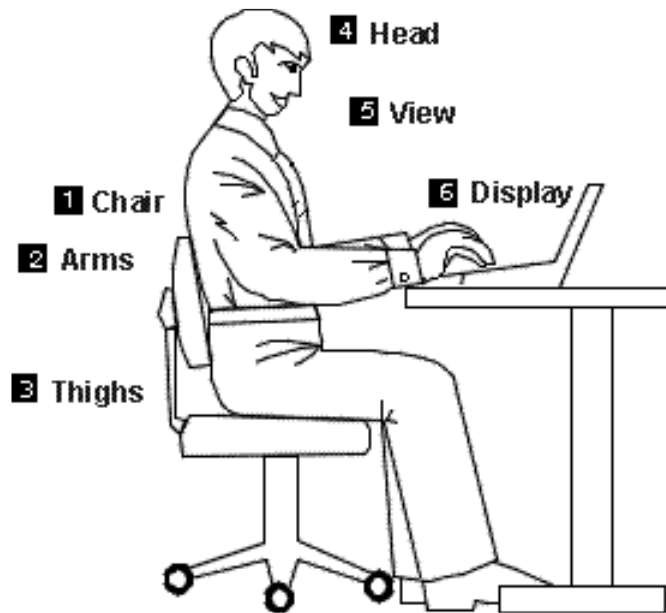

Note: *The example shown here of someone in a traditional setting. Even when not in such a setting, you can follow many of these tips. Develop good habits and they will serve you well.*

1 Chair

Use a chair that gives you good back support.

2 Arms

Keep your forearms, wrists, and hands in a relaxed and neutral position. Don't pound the keys; type with a soft touch.

3 Thighs

Keep your thighs parallel to the floor and your feet flat on the floor or on a footrest.

4 Head

Keep your head in a comfortable and vertical position.

5 View

Maintain a comfortable viewing distance of 20-30 inches.

6 Display

Position the display to avoid glare or reflections from overhead lighting or outside sources of light. Keep the display screen clean and set the contrast and brightness to levels that allow you to see the screen clearly.

What if I am traveling?

It may not be possible to observe the best ergonomic practices when you are using the ThinkPad computer while on the move or in a "casual" setting, such as the seashore or on a mountaintop. Sometimes, your lap may be the only "desk" around. Regardless of the setting, try to observe as many of the tips for proper usage as possible. Sitting properly and using adequate lighting, for example, will help you maintain desirable comfort and performance levels.

Questions about vision?

IBM's visual display screens are designed to meet the highest standards and to provide you with clear, crisp images and large, bright displays that are easy to see, yet easy on the eyes. Of course, any concentrated and sustained visual activity can be tiring. If you have questions on eye fatigue or visual discomfort, consult a vision care specialist for advice.

Safety Notice



DANGER

Do not disassemble, incinerate, or short-circuit the rechargeable battery pack. Do not put it in refuse that is disposed of in landfills. Dispose of it as required by local ordinances and regulations.

CAUTION:

The lithium battery can be replaced only by your dealer or an IBM service representative. It contains lithium and can explode if not properly used, handled, or disposed of. Do not: (1) throw or immerse into water, (2) heat to more than 100°C (212°F), or (3) repair or disassemble. Dispose of it as required by local ordinances or regulations.

CAUTION:

The fluorescent lamp in the liquid crystal display (LCD) contains mercury. Do not put it in refuse that is disposed of in landfills. Dispose of it as required by local ordinances and regulations.

The LCD is made of glass, and rough handling or dropping the computer can cause the LCD to break. If the LCD breaks and the internal fluid gets into your eyes or on your hands, immediately wash the affected areas with water for at least 15 minutes; then get medical care if any symptoms are present after washing.

Laser Compliance Statement (for the 310ED Only)

310ED The CD-ROM drive in the IBM ThinkPad 310ED is a laser product. The CD-ROM drive's classification label (shown below) is located on the top of the drive.

CLASS 1 LASER PRODUCT
LASER KLASSE 1
LUOKAN 1 LASERLAITE
APPAREIL A LASER DE CLASSE 1
KLASS 1 LASER APPARAT

The CD-ROM drive is certified in the U.S. to conform to the requirements of the Department of Health and Human Services 21 Code of Federal Regulations (DHHS 21 CFR) Subchapter J for Class I laser products.

In other countries, the drive is certified to conform to the requirements of EN60825.



CAUTION:

Do not open the CD-ROM drive; no user adjustments or serviceable parts are inside.

Use of controls, adjustments or the performance of procedures other than those specified may result in hazardous radiation exposure.

Class I (1) laser products are not considered to be hazardous. The CD-ROM drive has an internal, Class I (1), 0.5-milliwatt, aluminum gallium-arsenide laser that operates at a wavelength of 760 to 810 nanometers. The design of the laser system and the CD-ROM drive ensures that there is no exposure to laser radiation above a Class I (1) level during normal operation, user maintenance, or servicing conditions.

Distinctive System Features	iv
About This Book	vi
Information Notices.....	vii
Treatment of Icons.....	viii
Ergonomics Information.....	ix
Safety Notice	xi
Laser Compliance Statement (for the 310ED Only)	xii
Chapter 1. Getting Started	1-1
Overall Setup Procedures.....	1-2
Checking Your Items	1-4
Setting Up Your Computer.....	1-6
Chapter 2. Getting Familiar with Your Computer	2-1
Locations	2-2
System Status Indicators	2-6
Providing Power	2-8
Operating the TrackPoint III Pointing Device	2-10
Cleaning the Cap.....	2-12
Using the Fn Key Function.....	2-13
Operating the Numeric Keypad.....	2-15
Keeping the Computer from Being Damaged.....	2-16
Carrying the Computer	2-18
Chapter 3. Operating Your Computer.....	3-1
What Happens When Power Is Turned On?	3-2
Using Notebook Manager	3-3
Starting Notebook Manager.....	3-3
Using the Computer LCD or the External Monitor	3-13
Display Output Type.....	3-13
Points to Consider When Using the DOS Screen on the LCD....	3-14
Attaching a Monitor	3-14
Using SVGA Video Mode	3-16
Using PC Cards.....	3-18
About CardBus PC Cards	3-19
About Zoomed Video Port Cards	3-19
Audio Features	3-20
Using the External Diskette Drive	3-21
Using the CD-ROM Drive	3-22
Handling Compact Discs	3-23

Chapter 4. Using Battery Power	4-1
Charging the Battery Pack.....	4-2
Charging with the AC Adapter	4-2
Battery Pack Maintenance	4-4
Replacing the Battery Pack	4-5
Monitoring the Battery-Power Status	4-7
Using the Battery-Power Status Indicator	4-7
Using the Fuel-Gauge Icon	4-8
Preserving Battery-Pack Life.....	4-9
Maximizing Battery-Powered Operation	4-9
Using Advanced Power Management.....	4-9
Decreasing LCD Brightness	4-11
Using the Battery Power-Management Function.....	4-12
Chapter 5. Protecting Your Computer	5-1
Using the Power-On Password	5-2
Setting the Power-On Password.....	5-2
Changing the Power-On Password.....	5-3
Removing the Power-On Password.....	5-3
Entering the Power-On Password.....	5-3
Using the Setup Password.....	5-5
Setting the Setup Password	5-5
Changing the Setup Password	5-6
Removing a Setup Password	5-6
Entering the Setup Password	5-6
Using Locks	5-8
Using Locking Devices.....	5-8
Affixing a Nameplate.....	5-9
Chapter 6. Installing and Removing Options	6-1
Upgrading the Hard Disk Drive	6-2
Installing PC Cards	6-4
Removing PC Cards	6-7
Increasing Memory Capacity	6-8
Installing a DIMM	6-8
Removing a DIMM.....	6-10
Attaching an External Numeric Keypad or a Mouse.....	6-11
Attaching an External Keyboard	6-12
Attaching a Printer	6-13

Chapter 7. Installing Software	7-1
What You Need for Your Computer	7-2
Installing the Operating System and Device Drivers	7-3
Accessing Remote Software Services.....	7-4
Creating Installation Diskettes.....	7-5
Installing Software for DOS	7-6
Installing IBM PC DOS Version 7.0	7-7
Installing the CD-ROM Device Driver for DOS	7-7
Installing the Sleep Manager Program for DOS	7-7
Installing the Audio Device Driver for DOS.....	7-8
Installing the PC Card Driver for DOS	7-8
Installing Software for Windows 3.11	7-9
Installing Microsoft Windows 3.11.....	7-10
Installing the Display Driver for Windows 3.11.....	7-11
Installing the PC Card Program for DOS and Windows 3.11.....	7-12
Installing the Audio Support Software for Windows 3.11	7-13
Installing Software for Windows 95	7-14
Installing Microsoft Windows 95	7-15
Installing the Display Driver for Windows 95.....	7-15
Updating the PC Card Driver with Zoomed Video Support....	7-16
Installing the Audio Support Software for Windows 95	7-17
Installing the Sleep Manager Program for Windows 95.....	7-18
Installing the Notebook Manager Program.....	7-18
Installing the SafeOFF Program	7-18
Installing the TDial Program	7-19
 Chapter 8. Solving Computer Problems.....	 8-1
Frequently Asked Questions and Problems.....	8-2
Troubleshooting Charts.....	8-6
POST Error Codes	8-6
Runtime Error Codes.....	8-9
Getting Service.....	8-10
Recording your Computer Problem.....	8-11
Listing Installed Options	8-12
Recording Identification Numbers.....	8-12
How to Receive Customer Support and Service	8-13
Purchasing Additional Services	8-16
Obtaining IBM Operating System Updates	8-19
About Your Warranty.....	8-19

Appendix A. Avoiding Hardware Conflicts	A-1
Avoiding System Resource Conflicts	A-1
List of System Resources	A-2
Appendix B. Advanced Information for PC Cards.....	B-1
Phoenix Card Manager	B-2
PCMSsetup For Windows	B-3
Adding Options	B-3
Specifying a Fax/Modem Communications Port.....	B-3
Specifying the Flash File System Path.....	B-4
Setting Advanced Options.....	B-5
Event Processor Daemon (EPD) Utility	B-7
PCMRman For DOS	B-8
Displaying Resources.....	B-8
Modifying Resources.....	B-8
CardAgent Utility	B-10
Viewing the Client Driver List	B-10
Viewing the Event Log	B-11
Performing PC Card Diagnostics.....	B-12
Configuring PC Cards	B-13
Resolving PC Card Conflicts.....	B-14
Understanding Event-Triggered Associations	B-15
Appendix C. BIOS Utility.....	C-1
When to Use the BIOS Utility	C-2
Entering the BIOS Utility	C-3
Using the BIOS Utility	C-4
Exiting the BIOS Utility.....	C-4
Basic System Settings.....	C-5
System Security	C-7
Power Management Settings.....	C-13
Load Setup Default Settings.....	C-16
Appendix D. Features and Specifications	D-1
Specifications.....	D-3
Diskette Standards	D-4
IBM Power Cords	D-5

Appendix E. Notices	E-1
Notices	E-4
Trademarks.....	E-4
Electronic Emission Notices.....	E-5
Energy Star Logo Statement	E-6
Glossary	G-1
Index	I-1

Welcome to the world of ThinkPad computers!

The IBM ThinkPad 310E/310ED computer is designed to meet many multimedia and mobile computing needs. Its various features, unique to IBM products, can help your everyday work go easily and smoothly. You can use your IBM ThinkPad 310E/310ED computer in the office or at home as a desktop computer by attaching an external keyboard, display, or other external devices. And, of course, your computer can be easily carried wherever you need a computer “on the go.”

This chapter provides step-by-step instructions to help you set up your new computer.

Overall Setup Procedures.....	1-2
Checking Your Items	1-4
Setting Up Your Computer.....	1-6

Overall Setup Procedures

Before using the computer for the first time, review these overall setup procedures:

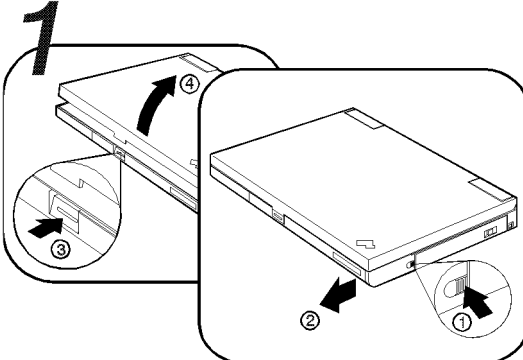
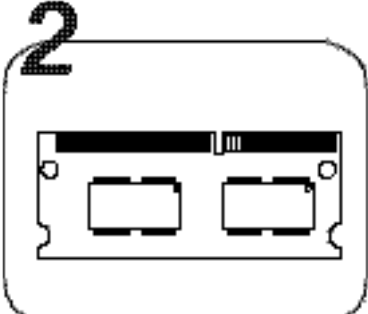
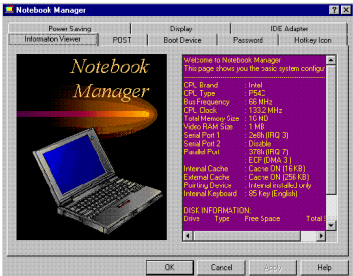
	<h3>Set Up the Computer</h3> <p>First, check whether you have all the necessary items with your computer.</p> <p>➔ Page 1-4.</p> <p>Then, install the battery pack in the computer. Now you are ready to turn on the computer.</p> <p>➔ Page 1-6.</p>
	<h3>Install Options</h3> <p>If you have any options, such as memory cards, install them now.</p> <p>➔ Chapter 6.</p> <p>Caution</p> <div style="border: 1px solid black; padding: 5px;"><p>Do not use any memory cards other than the IBM ThinkPad 310 memory cards.</p></div>
	<h3>Customize Your Computer</h3> <p>You can use Notebook Manager, a built-in system function, to set passwords to prevent your computer from unauthorized use, or use its other features to customize your computer.</p> <p>➔ Chapter 3.</p>

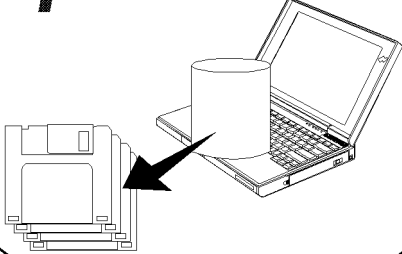
<p>4</p> 	<p>Make a Backup of Your System</p> <p>Some computers come with the necessary software already installed for you to use the computer right out of the box. Or, you may have installed the operating system and software yourself. Whichever is the case for you, remember to make a backup copy of your hard disk drive software.</p>
---	--

Do you need more hard disk space?

If your computer did not come with the utility and device driver diskettes, and you have already made a backup copy of all necessary software using a backup program, you can delete any preinstalled software you do not want to use to have more free hard disk space.

Run the backup program; then follow the instructions on the screen.

You can delete the demonstration program.



<p>You are ready to use your computer.</p> <p>If you have any application programs to install, follow the instructions in the documentation that came with those programs.</p>	<p>If you are reinstalling the operating system...</p> <p>If you are reinstalling the operating system to customize your computer, follow the instructions in Chapter 7, "Installing Software".</p>
---	--

 If you have any problems after you have customized your computer, refer to Chapter 8, "Solving Computer Problems" for troubleshooting help.

Checking Your Items

Remove everything from the shipping box and check that all necessary items were shipped with your computer.

1 Match the items, one by one, with the following figures.

If any item is missing or damaged, contact your place of purchase.

 **Computer**

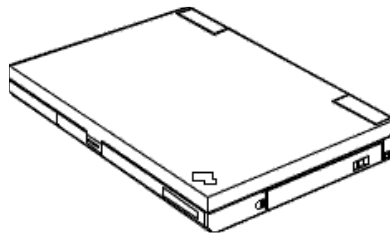

 **Battery Pack**

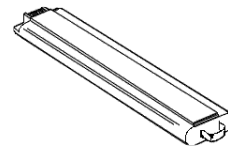

 **Power Cord**



 **AC Adapter**

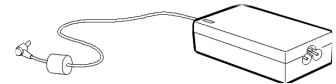

Caution

Do not use any batteries and AC Adapters other than the IBM ThinkPad 310 battery and the IBM ThinkPad 310 AC Adapter.

 **Diskette Drive**



**Windows 95 User's Guide with
the Certificate of Authenticity**

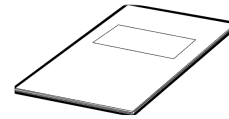

310E The *internal diskette drive* is installed in the computer.

310ED To use the *external diskette drive* and the CD-ROM drive at the same time, use the external diskette drive.

In some countries, the Certificate of Authenticity of Windows 95 is on the front cover of the Windows 95 user's guide. **The product ID number (ten digits) is in the Certificate. Keep it in a safe place in case you reinstall Windows 95.**

2 Turn the computer upside down and record the identification numbers on page 8-12.

- The machine type has a prefix of **Type**.
- The serial number has a prefix of **S/N**.

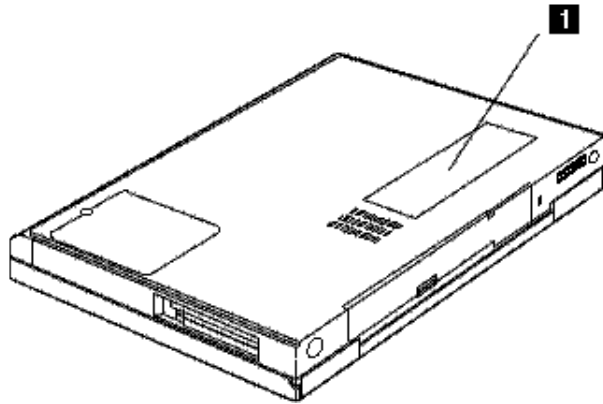

Setting Up Your Computer

You are now ready to assemble and start your computer. The steps on the next few pages guide you through the process. The following conventions are used in the steps and illustrations that appear in this book.

- 1** Indicates a main sequence of actions. This refers to the same number in the figure.
- ① Indicates a sequence of actions within a main action. An arrow accompanying a circled number shows the direction of movement.

Note

Battery packs shipped from the factory are in an almost-discharged state, so ***you must charge them fully before use.***

To install the battery pack:

- 1** Press the latch on the battery cover ①, and slide out the cover ②.
- 2** Slide the battery pack into the battery compartment until you feel the connectors engage ①. Then replace the cover ②.

1

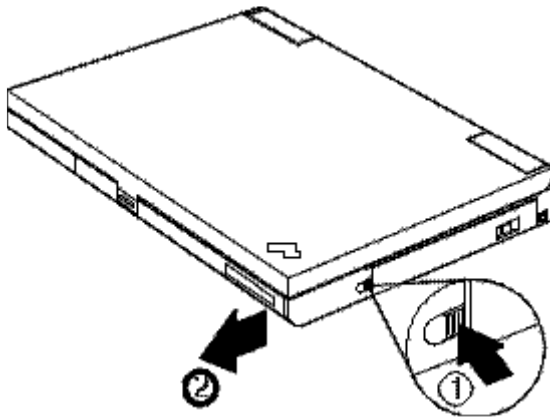

2

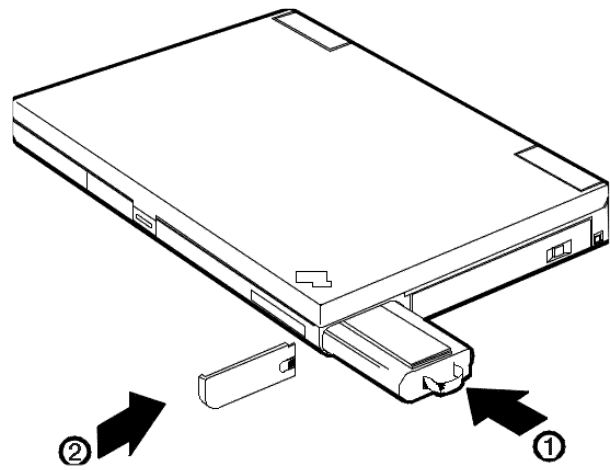





DANGER

The battery pack provided with your computer contains a small amount of harmful substances. To avoid possible injury:

- Keep the battery pack away from fire.
- Do not expose the battery pack to water or rain.
- Do not attempt to disassemble the battery pack.
- Avoid mechanical shocks to the battery.
- Always use battery packs recommended by IBM.
- Keep the battery pack away from children.

When disposing of the battery, comply with local ordinances or regulations or your company's safety standards.

- 3** Press the latch on the front of the computer, and open the liquid crystal display (LCD).
- 4** Connect the AC Adapter as shown.
(Connect , , and then .)
- 5** Push and release the power switch to turn on the computer.
- 6** After a single beep, a screen appears, confirming that the system is operating correctly.

If an error code and corresponding message shows on-screen, a problem might have occurred in the computer. See Chapter 8, "Solving Computer Problems".

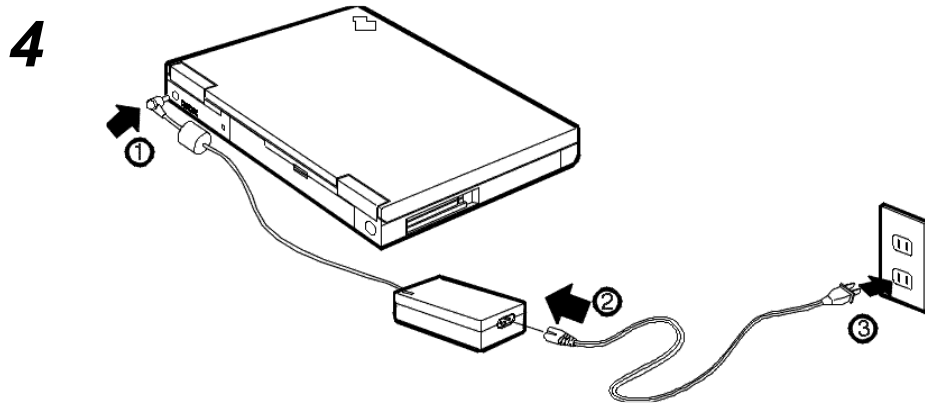
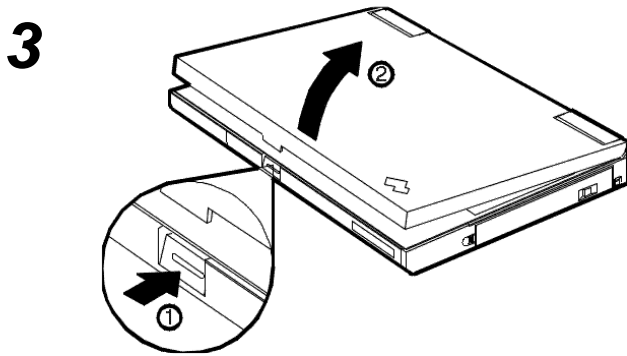

Getting Started

Congratulations! You have successfully completed the basic setup of your computer.

Important!

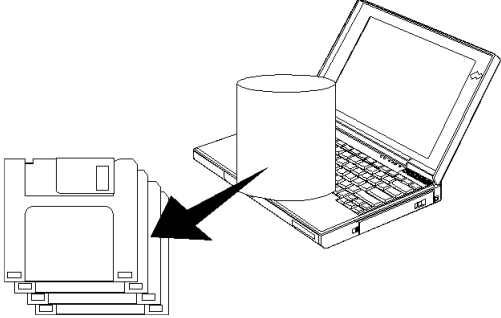

It is recommended that you make a backup copy of the files on the hard disk drive, in case you accidentally erase preinstalled software or intentionally modify the hard disk drive. You can use the backup copy to restore your computer to the way it was at the time when you made the backup copy.

In some countries, you can create the device driver diskettes you need to install all necessary software using the backup program. For more information, refer to Chapter 7, "Installing Software".













Chapter 2. Getting Familiar with Your Computer

This chapter provides general information for getting acquainted with your computer.

Locations	2-2
System Status Indicators	2-6
Providing Power	2-8
Operating the TrackPoint III Pointing Device	2-10
Cleaning the Cap.....	2-12
Using the Fn Key Function.....	2-13
Operating the Numeric Keypad.....	2-15
Keeping the Computer from Being Damaged.....	2-16
Carrying the Computer	2-18

Locations

Locations

-  To use the CD-ROM drive:
 Page 3-22.
-  To replace the battery:
 Page 4-5.
-  To use the TrackPoint III:
 Page 2-10.
-  To upgrade the hard disk drive:
 Page 6-2.
-  To use Fn functions:
 Page 2-13.
-  To install PC Cards:
 Page 6-4.

This section describes additional features of your computer.

Front View

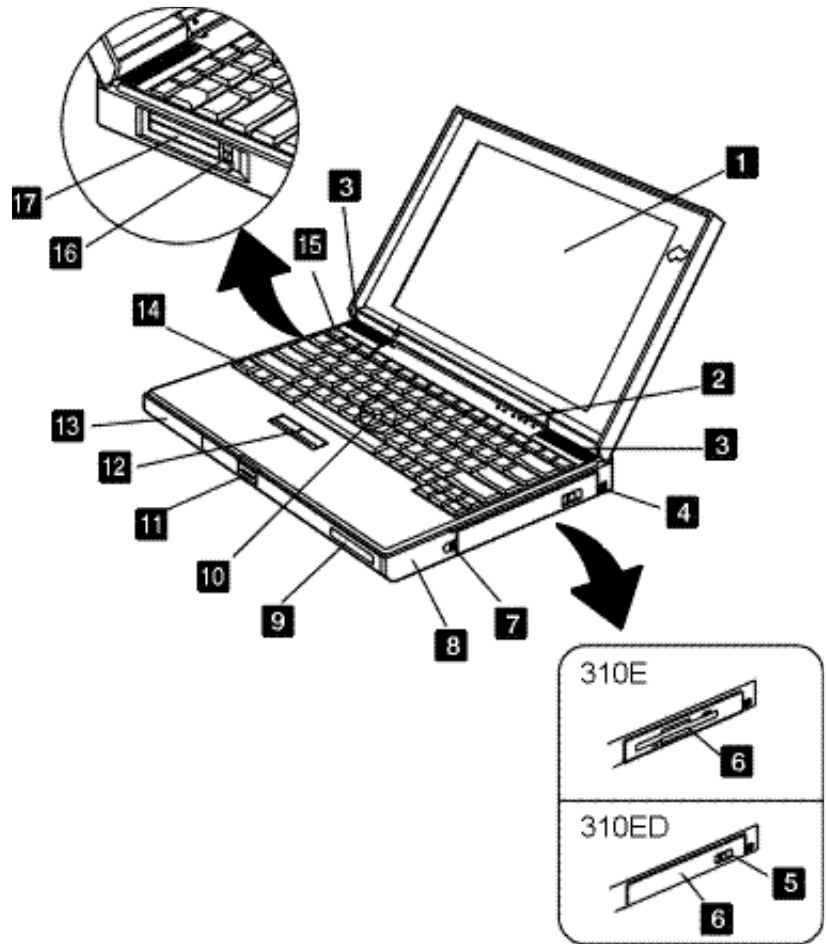

Front View

- 1 The **color LCD screen**, use either thin-film transistor (TFT) or dual-scan super-twisted nematic crystal (DSTN) technology (depending on the model) to display computer output in 800-by-600 resolution. High-resolution display modes can be used on the LCD or with an attached external display (See page 3-13.)
- 2 The **indicator panel** consists of the system status indicators and their related symbols. These indicators show the current status of the computer.
- 3 The **speakers** (left and right) provides sound for your application programs.
- 4 The **power switch** turns the computer on and off.
- 5  The **CD-ROM eject button** releases the CD-ROM tray for inserting, removing, or replacing a compact disc.
- 6 The **CD-ROM drive or diskette drive**.
- 7 The **battery cover release latch** releases the battery cover for installing and removing the battery pack.
- 8 The **battery bay** holds the battery pack. The battery pack allows you to operate the computer when ac power is not available.
- 9 **Personalization nameplate.** (See page 5-9.)
- 10 The **TrackPoint III** is a built-in pointing device that is as easy to use as a mouse without adding external devices to the system.
- 11 The **LCD release latch** releases the LCD screen so it can be opened.
- 12 The **click buttons** are used with the TrackPoint III.
- 13 The **hard disk drive bay** houses the hard disk drive. (See page 6-2.)
- 14 The **Fn key** is used with a function key or other keys to activate certain functions. (See page 2-13.)
- 15 The **function keys** can be used with or without the Fn key to activate various functions.
- 16 The **PC Card eject buttons** eject the PC Card from the upper or lower PCMCIA slots.
- 17 **PC Card slots.** (See page 3-18.)

Locations

2 To connect the AC Adapter:
☞ Page 1-8.

3 To secure your computer:
☞ Page 5-8.

6 To attach an external diskette drive:
☞ Page 3-21.

10 To attach a printer:
☞ Page 6-13.

11 To attach a display:
☞ Page 3-14.

12 To attach an external keyboard, mouse, or numeric keypad:
☞ Pages 6-11 to 6-12.

Rear View

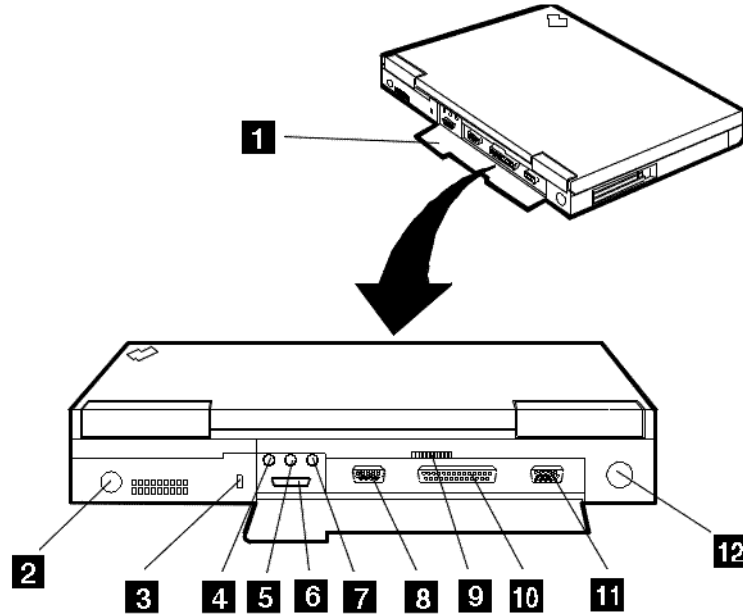

1 To install an optional memory module (DIMM):
☞ Page 6-8.

Bottom View

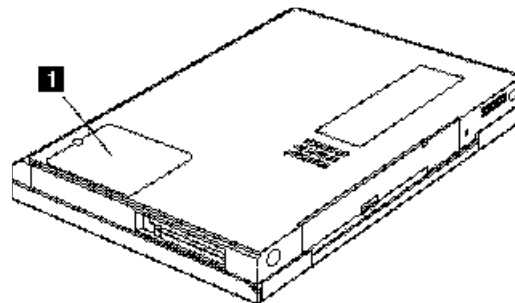

Rear View

- 1 The **rear door** covers the connectors on the rear of the computer.
 - 2 The **power jack** is where the AC Adapter cable is connected.
 - 3 The **security keyhole** is used when securing the ThinkPad with a Kensington MicroSaver Security System lock (hereafter called a Kensington lock) or compatible lock.
 - 4 The **microphone-in jack**, a 1/8-inch (3.5-mm) diameter jack, is where a stereo microphone is connected.
 - 5 The **line-in jack**, a 1/8-inch (3.5-mm) diameter jack, is where an external audio device is connected.
 - 6 The **external diskette drive connector** is where you connect the cable of the external diskette drive. (See page 3-21.)
 - 7 The **line-out/headphone jack**, a 1/8-inch (3.5-mm) diameter jack, is where you connect a stereo headphone or external speakers.
 - 8 The **serial connector** is where you connect a 9-pin, serial-device cable.
 - 9 The **fan** keeps the inside of the computer cool.
 - 10 The **parallel connector** is where you usually connect a parallel-printer signal cable. (See page 6-13.)
 - 11 The **external display connector** is where you attach an external monitor. (See page 3-14.)
 - 12 The **external input device connector** is where a mouse, an external numeric keypad, or the keyboard/mouse connector is plugged in. An external keyboard can also be connected through the keyboard/mouse connector.
-

Bottom View

- 1 The **memory door** covers the dual-inline memory module (DIMM) slots. Optional DIMM increases system memory capacity.

Caution

Do not use any memory cards other than the IBM ThinkPad 310 memory card.

System Status Indicators





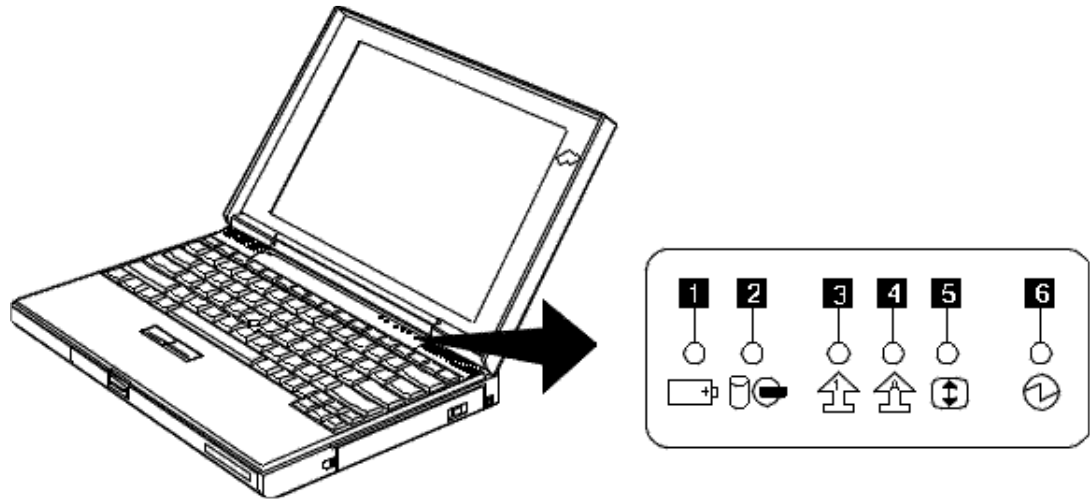

System Status Indicators

The system status indicators show the current status of your computer by their on or off states or colors (green and orange). Each indicator is identified with a symbol.

The following shows the location of each symbol and the meaning of each indicator.



System Status Indicators

Symbol	Color	Meaning
1 Battery 	Green	Enough battery power remains for operation.
	Orange	The battery pack is being charged.
	Blinking orange	The battery pack needs charging. When the lamp starts blinking orange, the computer beeps four times.
2 Hard disk or CD-ROM in use 	Orange	Appears when data is read from or written to the hard disk or read from the CD-ROM. Do not enter hibernation mode or turn off the computer when this indicator is on.
3 Numeric lock 	Green	Indicates that the numeric keypad on the keyboard is enabled. The keypad is enabled and disabled by pressing and holding the Shift key, and pressing the NumLk key. For details, see “Operating the Numeric Keypad” on page 2-15.
4 Caps lock 	Green	Indicates that the Caps Lock mode is enabled. All alphabetic characters (A-Z) are entered in capital letters without using the Shift key. The Caps Lock mode is enabled and disabled by pressing the Caps Lock key.
5 Scroll lock 	Green	Alternately turns on and off each time the ScrLk key is pressed. While this indicator is on, the Arrow keys are used as screen-scroll function keys. In this state, the cursor cannot be moved with the Arrow keys. Not all application programs support this function.
6 Power on 	Green	Indicates that the computer is operational. This indicator is on when the computer is on.

Providing Power

You can use your computer almost anywhere: at home, in the office, or on the road. Different power sources can be used for different conditions: the AC Adapter, or the battery pack. When you have access to an electrical outlet, you can use the AC Adapter for continuous power. Otherwise, you can use the battery pack.

AC Adapter

The AC Adapter is an alternating current (ac) to direct current (dc) converter that supplies power for the computer. The AC Adapter also charges the battery pack when it is installed in the computer.

Attention:

Always use the AC Adapter certified by IBM in the country where you will be using the computer. Operating the computer with an incorrect AC Adapter can cause damage to the battery pack and to the computer.

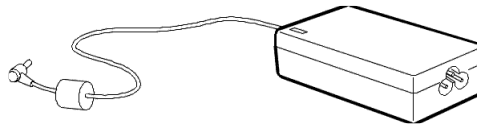

The input voltage is 100 — 240 V ac, 50/60 Hz. Refer to the label on your AC Adapter for the input voltage, and make sure you use the AC Adapter with the stated input voltage.



DANGER

Do not attempt to open the AC Adapter case. The AC Adapter is permanently sealed and cannot be repaired.

Battery Pack

The battery pack is an internal power source for the computer when no electrical outlets are available. The battery pack can be recharged with the AC Adapter.

The approximate operating time of the computer with a fully charged battery pack depends on the applications used, whether power management is used, the frequency of keystrokes, and the configuration of the system.

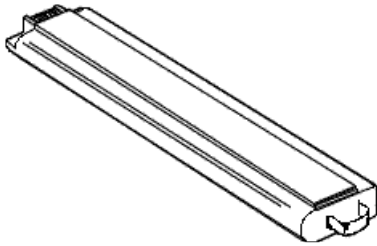

To ensure the longest possible battery life, in terms of both length of use per charge and number of charge and discharge cycles before wearing out, please observe these guidelines:

- Battery packs shipped from the factory are in an almost-discharged state, so you must charge them fully before use.
- When charging, always charge the battery pack fully. Even if you only need to run on battery power for a fraction of the battery's capacity, you should not try to give the battery a partial charge.
- Normal charging causes the battery pack to heat up slightly. Let it cool for 15 minutes before you use it.
- Immediately after the battery pack has been drained of power, it may be warm to the touch. This is normal. However it should be set aside to cool for 15 minutes before recharging.

Operating the TrackPoint III Pointing Device

Note:

No other software is required for the TrackPoint III; it works with the PS/2 mouse driver.

The keyboard contains a unique cursor-pointing device called TrackPoint III. Pointing, selecting, and dragging all become part of a single process, so you need not move your fingers from their normal typing position.

The TrackPoint III consists of a stick **1** on the keyboard and a pair of click buttons **2** in front of the keyboard. The motion of the cursor is controlled by pressure applied to the stick in any direction within the plane of the keyboard; the stick does not move. The speed at which the cursor moves corresponds to the amount of pressure on the stick. The click buttons are similar in function to those on other pointing devices; what they do depends on the software that is used.

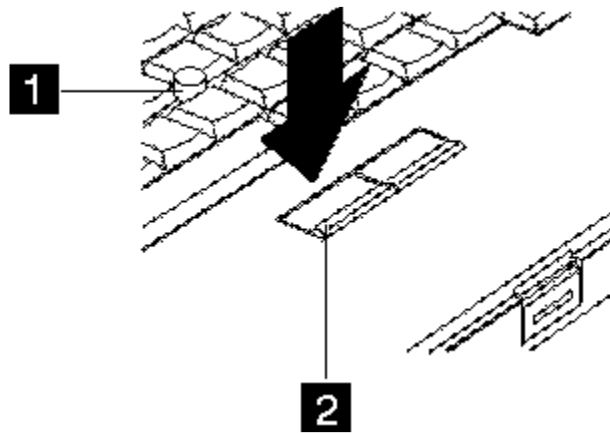

If you are new to the TrackPoint III, these instructions will help you get started.

Note:

Remember that the stick does not move.

Note:

The mouse pointer may drift. This is not a defect. Do not use the TrackPoint III until the pointer stops moving.

Note:

Either thumb can be used.

- 1** Place your hands in the typing position and press gently with either index finger in the direction in which you want the cursor to move.

Pressing the stick away from you moves the cursor up the screen; pressing it toward you moves the cursor down the screen.

- 2** Use the click buttons to select and drag as required by your software, in the same way as for any other pointing device.

Operating the TrackPoint III Pointing Device

Cleaning the Cap

The cap on the end of the TrackPoint III is removable. You can replace it with one of the spares shipped with your computer when the cap is worn out.



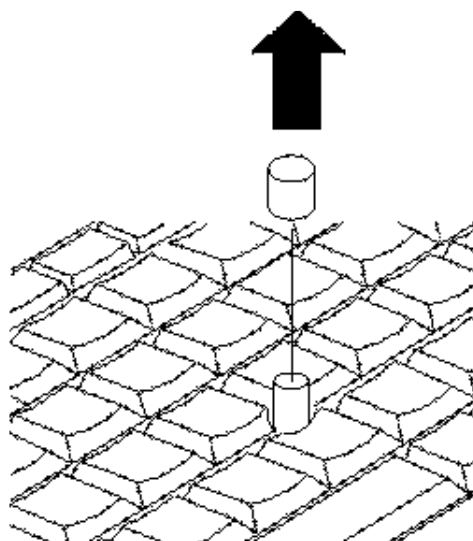





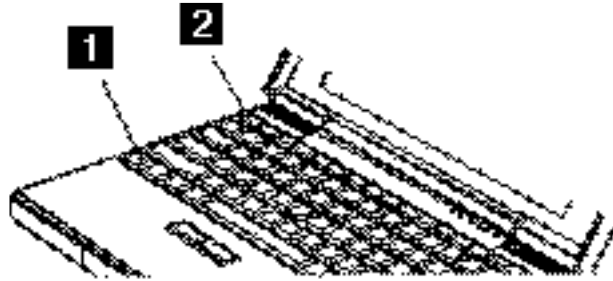

To maintain a smooth pointing operation, occasionally clean the cap with a soft cloth moistened with a nonalkaline detergent.















Using the Fn Key Function

The **Fn** key function allows you to change operational features instantly. When you use the following functions, press and hold the **Fn** key **1**; then press the appropriate key **2** (**Esc**, cursor left ← and right → keys, function keys **F1** to **F8**.)



Key Combination	Feature	Meaning
 + 	Close Hotkey Icon Esc	Closes the current pop-up icon.
 + 	Key Combination Help 	Displays the key combination help screen. Press Esc to exit.
 + 	Brightness / Contrast 	Displays the brightness and/or contrast pop-up icons; toggles between the brightness and contrast pop-up icons. Use the scale key combinations Fn+→ , Fn+← to adjust the brightness or contrast. Contrast adjustment is only available for DSTN models.
 + 	LCD/external monitor switching 	Displays the computer output in the following order when an external monitor is attached. Both → LCD only ← CRT only ←

Using the Fn Key Function

Key Combination	Feature	Meaning
	Fuel-Gauge display on or off 	Displays the fuel-gauge pop-up icon.
	Speaker volume 	Displays the speaker volume pop-up icon. Use the scale key combinations Fn+→ , Fn+← to adjust the volume. Note: To save the speaker volume level in the computer, use the volume control function of the operating system or the audio support software (Yamaha Station**) shipped with your computer.
	Power Management Settings and System Information 	Displays the Power Management Settings and System Information screens. The Power Management Settings screen contains items used for power management. See page C-13. The System Information screen shows information about your computer by listing a summary of the BIOS Utility settings. The Notebook Manager shows the same information in the Information Viewer tab. See page 3-4.
	Standby mode 	Places the computer in standby mode. For more information about this mode, see page 4-14.
	Hibernation mode 	Places the computer in hibernation mode. For more information about this mode, see page 4-15.
	Scale up	Increases the level of the current pop-up icon. Refer to Fn+F2 and Fn+F5 .
	Scale down	Decreases the level of the current pop-up icon. Refer to Fn+F2 and Fn+F5 .

Operating the Numeric Keypad

The keyboard has some keys that, when enabled, work as a 10-key numeric keypad.

To enable the numeric keypad, press and hold **Shift**, then press **NumLk**.

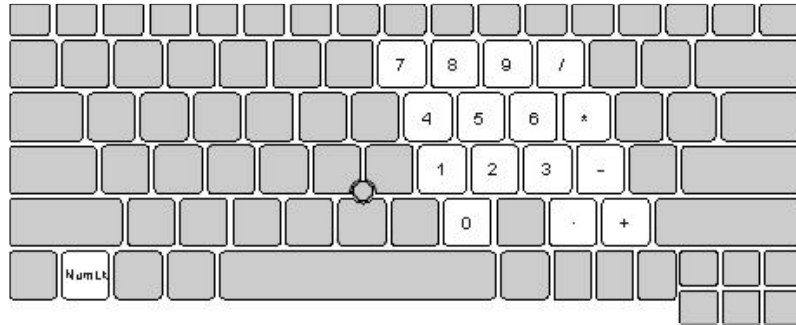

While in this mode, press and hold Shift to temporarily use the cursor and screen control keys.

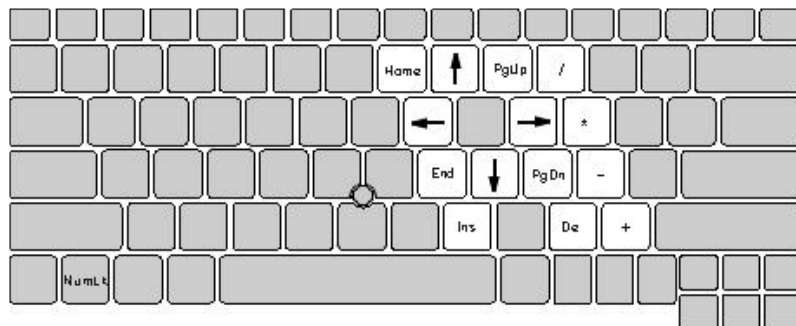

To disable the numeric keypad, press and hold **Shift**; then press **NumLk** again.

Keeping the Computer from Being Damaged

Your computer is a delicate device that requires careful handling. To keep it from being damaged, keep these precautions in mind:

- Do not place anything heavy on your computer.
- Do not scratch, twist, hit, or press the surface of the LCD.
- Keep the computer at least 130 mm (5 in.) away from any electrical appliance that generates a strong magnetic field (for example, magnets, motors, TVs, refrigerators, or large audio speakers).
- Use your computer when the temperature is from 10°C to 35°C (50°F to 95°F).
- Remove the battery pack and keep it in a cool place if you do not plan to use the computer for a long period of time.
- Do not disassemble the computer.
- Do not leave any objects (especially metal objects) in the computer.
- Do not pour liquids into the computer.
- Do not drop or apply shock to your computer.

The hard disk drive, CD-ROM drive, and diskette drive are very delicate devices that need careful handling. To avoid damage, do not press on, drop, or apply any shock to them.

- Do not press on the middle part of the CD-ROM drive or the diskette drive at any time.
- Do not touch the lens on the CD-ROM tray.
- Do not use benzene, thinners, or other cleaners to clean the lens on the CD-ROM tray. Use a CD-ROM cleaner kit.
- Do not place more than one diskette label on a diskette. Two or more labels can cause a label to tear apart inside the drive and cause damage to the diskette drive.
- Insert a diskette straight into the diskette drive. Inserting it at an angle can damage the front of the diskette drive.

Keeping the Computer from Being Damaged

Occasionally clean your computer as follows:

- Use a soft cloth moistened with a nonalkaline detergent to wipe the exterior of the computer.
- Gently wipe the LCD with a dry, soft cloth. Avoid using alcohol or detergent to clean the LCD.

Carrying the Computer

When carrying the computer, follow these instructions to prevent possible damage to your computer and data.

- 1** Remove any CD-ROM from the CD-ROM drive or any diskette from the diskette drive.
- 2** Turn off all attached devices.
- 3** Turn off the computer and close the LCD.
- 4** Unplug all external cables and cords connected to the computer.
- 5** Make sure all computer doors and covers are closed.

For Your Information

1. You should occasionally back up data from the hard disk to diskettes or tapes.
2. To use the AC Adapter outside your home country, you need an ac power cord that is certified for the country you are visiting. You can purchase one through IBM or an IBM authorized dealer in that country. For more information about power cords, see page D-5.
3. A carrying case is available from IBM or an IBM authorized dealer.

Chapter 3. Operating Your Computer

This section provides information about using your computer.

What Happens When Power Is Turned On?	3-2
Using Notebook Manager	3-3
Starting Notebook Manager	3-3
Information Viewer	3-4
POST	3-5
Boot Device	3-6
Password	3-7
Hotkey Icon	3-8
Power Saving	3-9
Display	3-11
IDE Adapter	3-12
Using the Computer LCD or the External Monitor	3-13
Display Output Type	3-13
Points to Consider When Using the DOS Screen on the LCD	3-14
Attaching a Monitor	3-14
Setting the Monitor Type and the Display Driver	3-15
Connecting an External Monitor to the Computer	3-16
Using SVGA Video Mode	3-16
Using PC Cards	3-18
About CardBus PC Cards	3-19
About Zoomed Video Port Cards	3-19
Audio Features	3-20
Using the External Diskette Drive	3-21
Using the CD-ROM Drive	3-22
Handling Compact Discs	3-23

What Happens When Power Is Turned On?

What Happens When Power Is Turned On?

You see one of the following prompts when the computer is turned on:

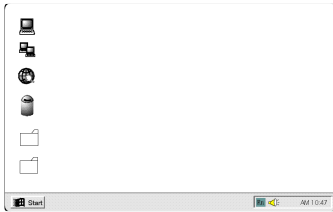

An operating system screen appears when the computer is operating correctly. The screen you see may differ depending on your operating system.

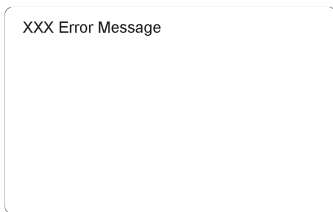

This screen indicates that a failure occurred during the power-on self-test (POST). See Chapter 8, "Solving Computer Problems" for the necessary actions.

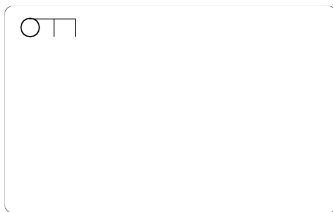

This icon appears when a Power-On password is set. To start the computer, enter the correct password.

Using Notebook Manager

Note:

Certain **Fn** key functions are disabled when you access the notebook manager, because these functions are also found in the notebook manager.

The computer has a built-in system setup program called Notebook Manager. The Windows 95-based Notebook Manager allows you to set passwords, the startup sequence of the drives and power management settings. It also shows current hardware configurations.

Starting Notebook Manager

To start the Notebook Manager:

- 1** Click on the Start button.
- 2** Select the Programs folder.
- 3** Select the Notebook Manager folder.
- 4** Select the Notebook Manager application to run the program.

Note:

Making changes to most settings in the Notebook Manager take effect the next time the computer restarts. If you make changes in the Hotkey Icon, Power Saving and Display screens, these changes take effect immediately.

Notebook Manager consists of eight sections:

- Information Viewer
- POST
- Boot Device
- Password
- Hotkey Icon
- Power Saving
- Display
- IDE Adapter

To select a section, click on the tab of the section you want to view.

Using Notebook Manager

Information Viewer

Infoviewer summarizes and lists information about the specifications and settings of the different components of your computer.

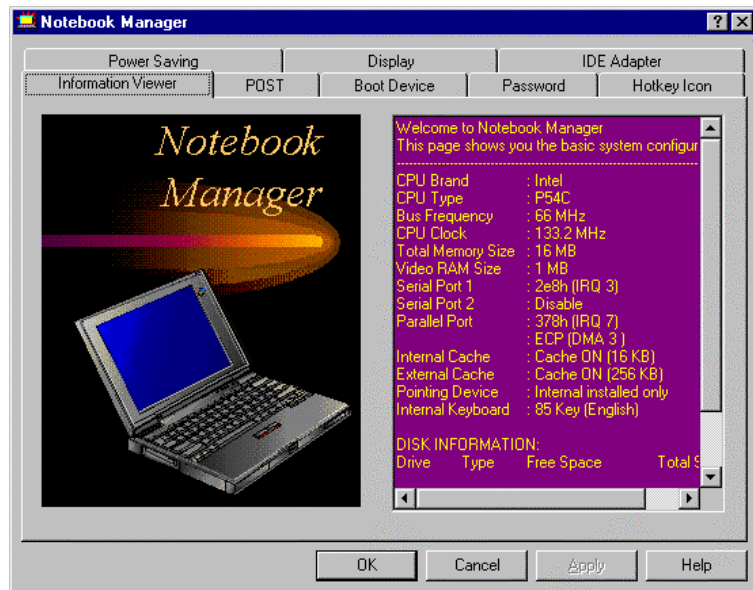

Note:
Items in this table may differ slightly from the ones onscreen.

Information Viewer Items

Item	Description
CPU Brand	Brand of the CPU.
CPU Type	Type of the CPU.
Bus Frequency	Bus frequency of the CPU.
CPU Clock	Clock speed of the CPU.
Total Memory Size	Total amount of main memory.
Video RAM Size	Total amount of video memory.
Serial Ports	Settings (I/O address and IRQ) of the serial port(s).

Item	Description
Parallel Port	Settings (I/O address and IRQ) of the parallel port.
Internal Cache	Total amount of internal cache (CPU cache) memory and if it is enabled or not.
External Cache	Total amount of external cache (L2 cache) memory and if it is enabled or not.
Pointing Device	Type of the pointing device detected.
Internal Keyboard	Type of the internal keyboard
Disk Information	Information on drive type, free size and total size by logical drive

POST

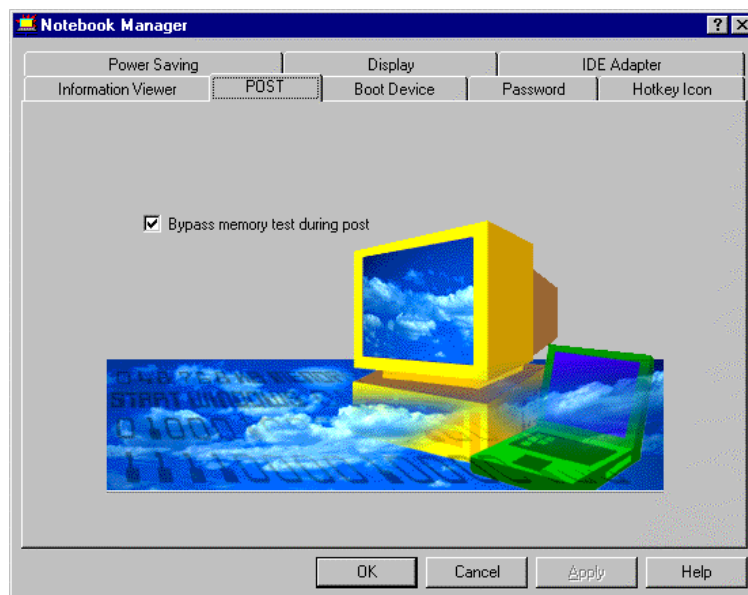

POST is used to define how you want your computer to boot up (startup). Enable *Bypass memory test during POST* to bypass the memory test to speed up booting. Then click on **Apply** to accept.

Boot Device

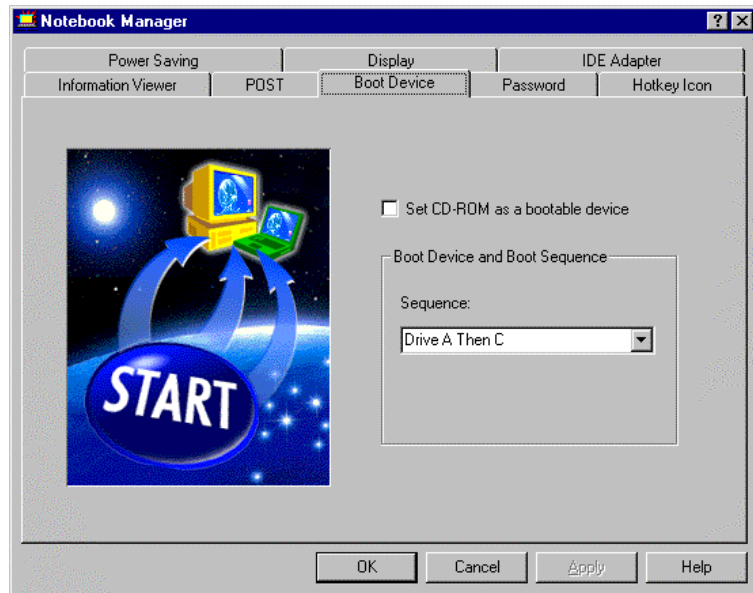

Boot Device is used to defines the boot sequence to follow when your computer boots up. The Boot Device screen displays the following items:

- *Set CD-ROM as a Bootable Device.* When enabled, the computer checks from the CD-ROM drive first for a bootable CD-ROM disc. If there is no bootable CD-ROM disc or no CD-ROM is present, the computer follows the selected Boot Sequence setting.
- *Boot Device and Boot Sequence.* This controls the startup sequence of the drives in your computer. The four settings are:

Item	Description
Drive A then C	The computer boots from the diskette drive. If no system diskette is found in the diskette drive, the computer boots from the hard disk drive. If the hard disk drive is not a system disk, an error message displays.
Drive A	The computer boots from the diskette drive. If no system diskette is present in the diskette drive, an error message displays.
Drive C	The computer boots from the hard disk drive. If the hard disk drive is not a system disk, an error message displays.
Drive C then A	The computer boots from the hard disk drive. If the hard disk drive is not a system disk, the computer boots from diskette drive. If no system disk is present in the diskette drive, an error message displays.

Click on the drop-down list box and select the desired sequence, then click on **Apply** to accept.

Password

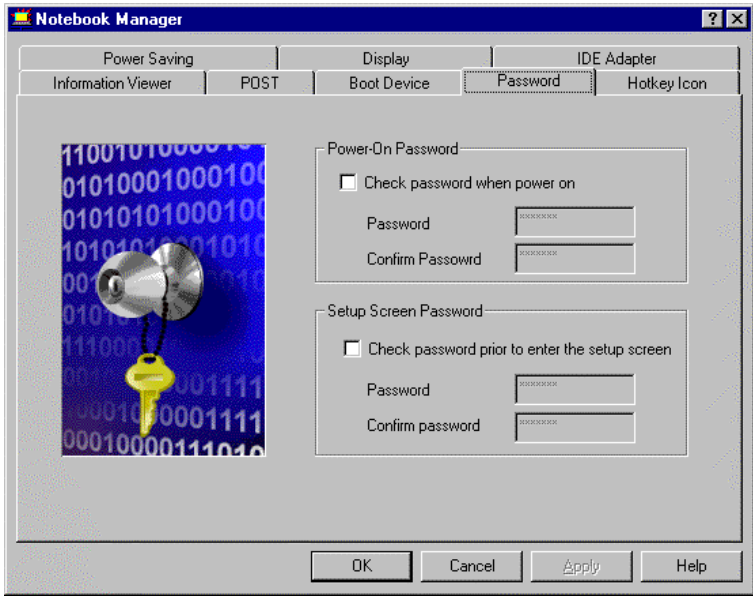

Using Notebook Manager

Password is used to set, modify or delete the password(s) for your computer. There are two passwords used in the system:

- *Power-On Password.* The power-on password prevents unauthorized access to your computer at system startup and at resume from hibernation mode.
- *Setup Screen Password.* The setup password prevents unauthorized access to the Notebook Manager and BIOS Utility.

For more information on passwords, see Chapter 5.

Hotkey Icon

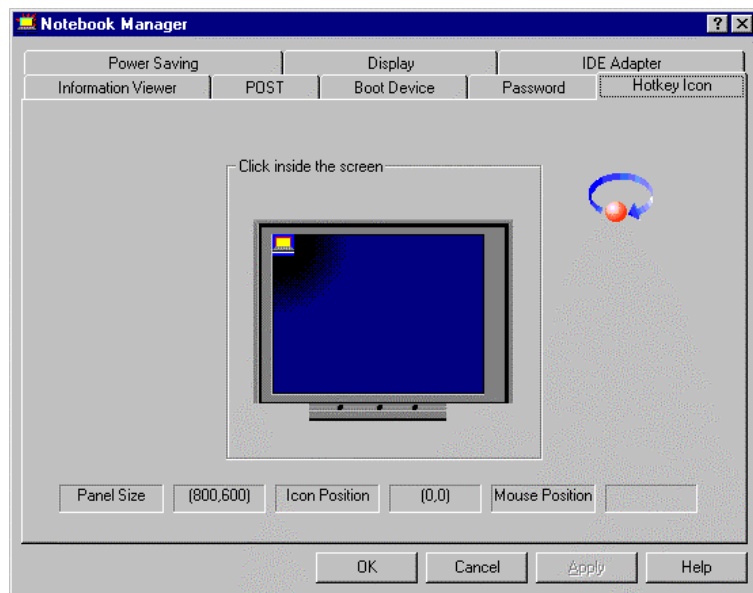

HotKey Icon is used to set the position where hotkey icons should pop-up.

Move your cursor inside the monitor to select the position where you want hotkey icons to pop-up, then double-click the right button to set. Click on **Apply** to accept.

Power Saving

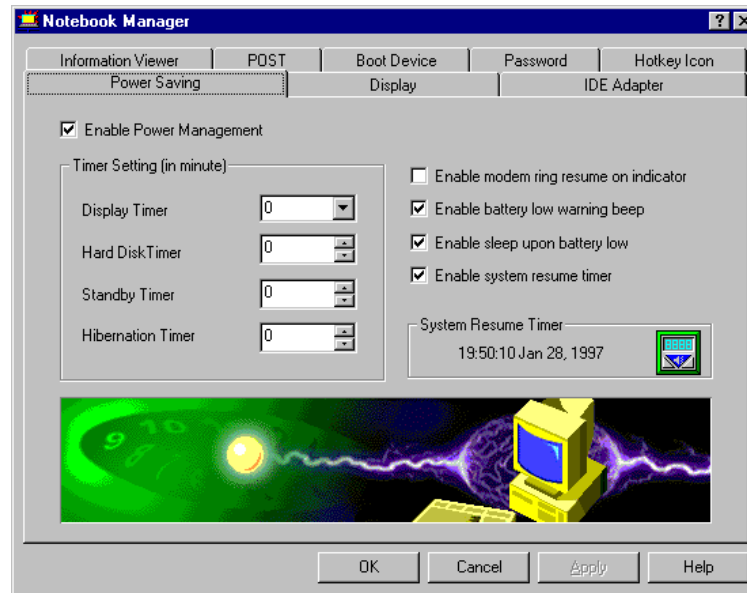

Power Saving is used to set various settings related to power management. This includes the power-saving time-outs, the power-saving mode to enter, and other special power-saving features:

- *Enable Power Management.* Select to enable power management based on the settings in this screen.
- *Timer Settings.* Sets the time-out values for four power-saving timers — display, hard disk, standby and hibernation.
- *Enable Modem Ring Resume Indicator.* Select to allow the computer to wake-up from standby mode when an incoming modem ring is detected.
- *Enable Battery Low Warning Beep.* Select to allow the computer to give off warning beeps when the computer runs low on battery.
- *Enable Sleep Upon Battery Low.* Select to allow the computer to enter standby or hibernation mode when the computer runs low on battery.

Using Notebook Manager

- *Enable System Resume Timer.* Select to allow the computer to wake-up from standby mode if the resume timer is set and matched.
- *System Resume Timer.* (When Enable System Resume Timer is selected) click to set the System Resume Timer.

Select the desired item by clicking on the checkbox of the desired item, then click on **Apply** to accept.

Setting the Power Management Timer Settings

To modify Timer Settings for each individual power management timer, use the spinner controls.

Setting the System Resume Timer

To set the alarm time, click on the System Resume Timer button, then set the desired date and time using the pop-up calendar and clock.

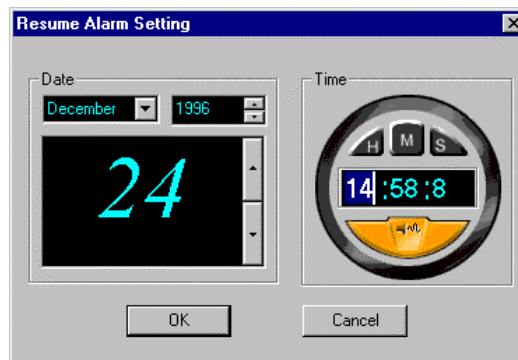

Display

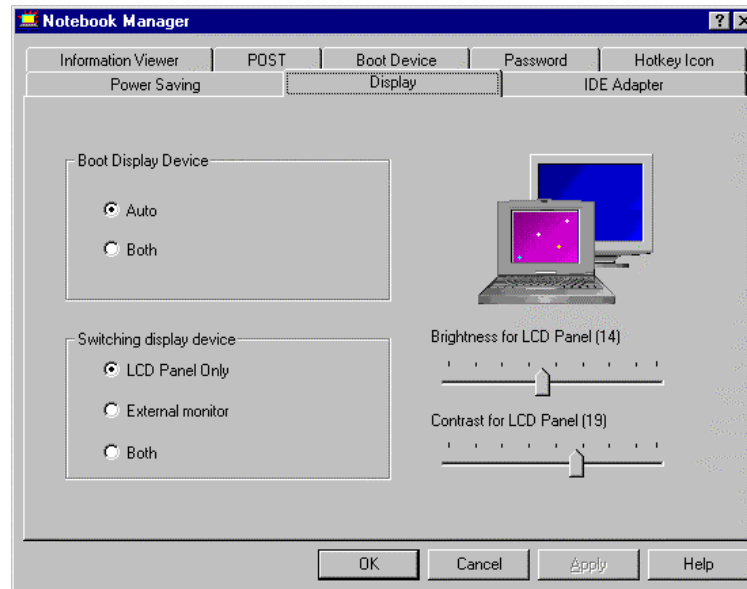

Display is used to control various settings related to display, such as the display device, and display brightness/contrast levels. The items in this screen include:

- *Boot Display Device.* Sets the default display device on boot-up.
- *Switching Display Device.* Sets the current display device.
- *Brightness for LCD Panel/Contrast for LCD Panel.* Click and drag to set the LCD screen brightness and contrast levels.

Note:

Make sure an external monitor is connected before External Monitor is selected.

Note:

TFT active-matrix LCDs have fixed and optimized contrast levels.

Select the desired item by clicking on the radio button of the desired item, then click on **Apply** to accept. To modify the brightness and/or contrast levels, click and hold the slider control and move to the right to increase, move to the left to decrease the setting. You can also click on the item, and use the cursor keys to set the desired level.

IDE Adapter

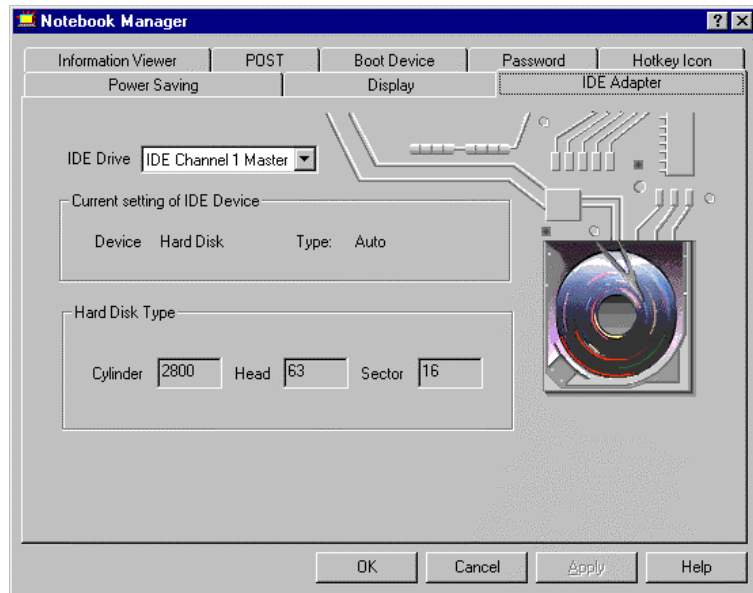

IDE Adapter shows information on the IDE drives (hard disk drive and/or CD-ROM drive) installed on your computer.

- *IDE Drive.* Selects the IDE drive you want to view information on.
- *Current Setting of IDE Device.* Shows the IDE device and type of the currently-selected IDE device.
- *Hard Disk Type.* Shows information on the hard disk drive.

Select the desired item to view by clicking on the drop-down list box of the desired item.

Using the Computer LCD or the External Monitor

This section provides information about using the computer display and an external monitor. It also provides tips to consider when using DOS applications.

The LCD in your computer displays computer output with SVGA (800-by-600 resolution). On some models, thin-film-transistor (*TFT*) technology is used, providing up to 65,536 colors. On some models, dual-scan super twisted nematic (*DSTN*) technology is used, providing up to 256 colors.

Display Output Type

To attach an external monitor:



Page 3-16

When you attach an external monitor that supports higher resolution than VGA mode, you can get a maximum of 1024x768 video resolution.

To display your computer output on an external monitor, you need to set the appropriate display output type (where to display the computer output). You can select one of the following display output types:

- *LCD*: The computer output is displayed only on the LCD of the computer.
- *CRT*: The computer output is displayed only on the attached external monitor.

If no external monitor is attached to the computer and the display output type is set to *CRT*, the output is displayed on the *LCD*.

- *Both*: The computer output is displayed on both the LCD and the external monitor.

Using the Computer LCD or the External Monitor

You can select where to display the computer output by using the following commands:

- *Using the **Fn** key function:* Press and hold the **Fn** key; then press **F3** key. The setting toggles sequentially between *LCD*, *CRT* and *Both*.
- *Using the Notebook Manager function:* Click on the **Display** tab; then select *LCD Panel Only*, *External monitor* or *Both* as the switching display device.

Points to Consider When Using the DOS Screen on the LCD

When you use a DOS application that supports only VGA mode (640-by-480 resolution) with your computer, the screen image might look slightly distorted or might appear smaller than the display size.

This is to maintain compatibility with DOS applications.

Attaching a Monitor

Note:

When installing an operating system, you must install the display driver before you can use an external monitor.

Your computer supports the following color depth and resolution on an attached monitor:

Color	Resolution
256 colors	640 by 480
	800 by 600
	1024 by 768
65,536	640 by 480
	800 by 600
16,777,216 colors	640 by 480

Attention:

When you select **Both**, do not attach an external monitor that supports only VGA mode (640-by-480 resolution). Otherwise, the external monitor screen will be scrambled and the output will not be displayed, or the screen might be damaged.

To attach an external monitor:

- 1** Change the display output type to CRT or Both. (See “Display Output Type” on page 3-13.)
- 2** Set your monitor type and display device driver. (See “Setting the Monitor Type and the Display Driver” on page 3-15.)
- 3** Attach the external monitor to the computer. (See “Connecting an External Monitor to the Computer” on page 3-16.)

Setting the Monitor Type and the Display Driver

Before attaching the external monitor to your computer, set the appropriate monitor type and device driver type as follows:

Note:

Refer to the specifications for your external monitor to determine its supported resolutions and refresh rates.



- 1** In the Control Panel, double-click on the **Display** icon.
- 2** Select the **Settings** tab.
- 3** Click on **Advanced Properties**.
- 4** Select the **Monitor** tab; then click on **Change...**
- 5** Change the **Manufacturers** and **Models** to the appropriate settings.
- 6** Click on **OK**.



- 1** In the Control Panel, double-click on the **ChipsCPL** icon.
- 2** Select item (your monitor) from the **Monitor Selection** list.
- 3** Click on **OK**.

Using the Computer LCD or the External Monitor

Connecting an External Monitor to the Computer

To attach an external monitor to the computer:

- 1 Turn off the computer.
- 2 Attach the external monitor to the external monitor connector and then to the electrical outlet.
- 3 Turn on the external monitor and the computer.

Using SVGA Video Mode

Note:

When installing an operating system, you must install the display driver supplied with the computer to use SVGA mode.

The IBM ThinkPad 310E/310ED models have an LCD screen that supports an SVGA video mode with 800-by-600 resolution. You can also display information in higher resolutions by attaching an external monitor to your computer that supports higher resolutions.

The table shows the various display modes available with your computer.

Display Modes	TFT (1 MB)	DSTN (1 MB)
Resolution and Color Depth (LCD only)		
640x480 (full screen)	16,777,216	65,536
800x600 (full screen)	65,536	256
1024x768 (virtual screen)	256	256
External Resolution and Color Depth (CRT only)		
640x480	16,777,216	16,777,216
800x600	65,536	65,536
1024x768	256	256
1280x1024	16	16

Using the Computer LCD or the External Monitor

Simultaneous Display (LCD/CRT)		
640x480	16,777,216 (LCD) / 16,777,216 (CRT)	65,536 (LCD) / 65,536 (CRT)
800x600	65,536 / 65,536	256 / 256
1024x768 (virtual screen)	256 / 256	256 / 256
1280x1024 (virtual screen)	16 / 16	16 / 16

Using PC Cards

Your computer has two slots that allow you to install 68-pin, 85.6 mm x 54.0 mm (credit-card-size) PC Cards. With a PC Card, you can send and receive faxes, communicate via a network, or store data.

The PC Card slots of the computer conform to the PCMCIA Standard release 2.01 or later that is defined as the hardware layer of the PC Card standard. Your computer also comes with a basic set of drivers:

- Socket Services
- Card Services

The PC Card slots operate at 5V or 3.3V and support the following:

- Type I, Type II, and Type III PC Cards.
- 16-bit PC Card (PCMCIA 2.0, 2.1 / JEIDA 4.1, 4.2).
- 32-bit PC Card (CardBus PC Card).
- Zoomed Video Port PC Cards (only lower slot).

Important!

Before using CardBus PC Cards or Zoomed Video port PC Cards, you must change **CardBus Support** to **Enabled** in the BIOS Utility. See Appendix C.

Note that the PC Card slots do not support 8-bit or 16-bit slave DMA PC Cards. Ask IBM or an IBM authorized dealer for more information about the different types of PC Cards.



Before you can use PC Cards under DOS and Windows, you first need to install the PC Card program. (See pages 7-8 and 7-12). Then refer to the documentation that came with your PC Card to use the card.

For more information about PC Cards, see Appendix B.

About CardBus PC Cards

Note:

CardBus PC Cards are supported by Windows 95 only.

A newly inserted CardBus PC Card might not be recognized correctly by Windows 95 (that is, Windows 95 might mistake it for a previously installed CardBus PC Card). If this happens, do the following



- 1** Open **My Computer**, **Control Panel** and then **System**.
- 2** Click on the **Device Manager** tab.
- 3** Select a device that is no longer being used. You can select more than one.
- 4** Remove the device (or devices).
- 5** Restart the system.

About Zoomed Video Port Cards

Note:

CardBus Support needs to be enabled in the BIOS Utility to use the ZV port. See page C-12.

Only the lower PC Card slot supports ZV PC Cards.

Support for ZV (Zoomed Video) port allows your computer to accept ZV PC Cards such as one with hardware MPEG capability. A ZV card should be inserted into the lower slot.

Audio Features

The built-in audio features let you record and playback sound from various sources.

These features include:

- A built-in sound chip on the system board, providing 16-bit stereo audio that supports Microsoft Windows 3.1, Windows 95, Microsoft Sound System, and most programs that use the Sound Blaster/Sound Blaster Pro standard.
- The ability to perform real-time recording.
- Scalable sampling rate (from 4 to 44.1 kHz) and compression ratio that give complete control of record time to required storage ratio.
- Digitally controlled volume with muting.
- Microphone line-in jack, line-in jack, and line-out/headphone jack for maximum flexibility.
- Built-in stereo speakers to enhance portability.

To adjust the volume of your internal speaker, speakers attached to the line-out port on the computer, follow these instructions:

- 1** Press the **Fn+F5** key combination to bring up the volume control icon.
- 2** Press the **Fn+→** and **Fn+←** key combinations to increase and decrease the volume level respectively.
- 3** Press the **Fn+Esc** key combination to close the icon and save the setting.

Using the External Diskette Drive

IBM ThinkPad 310ED models come with a built-in CD-ROM drive and an external diskette drive.

IBM ThinkPad 310E (those without a built-in CD-ROM drive) come with the diskette drive already installed internally.

To install the external diskette drive, simply plug the diskette drive cable into the diskette drive port, located on the rear panel of the computer. The ThinkPad automatically senses the presence of the drive and configures itself accordingly.

Power to the diskette drive is provided through this connecting cable. The diskette drive does not have its own internal power source. It draws its power from the ThinkPad.

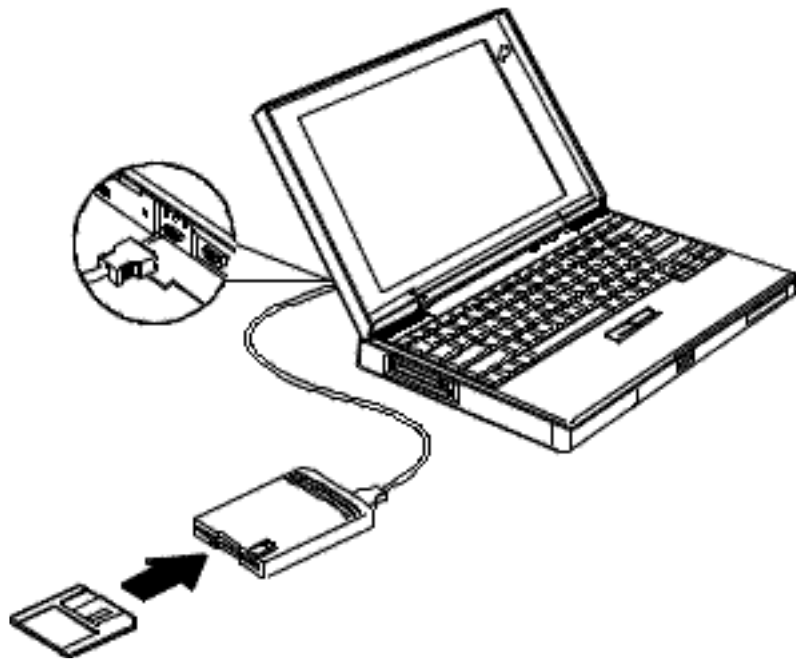

Using the CD-ROM Drive

IBM ThinkPad 310ED models come with a built-in CD-ROM drive, so you can use compact discs (CDs).

The following CDs are supported by the computer:

- Music CDs
- Photo CDs
- CD-ROM or CD-ROM XA discs

Attention:

Hold the CD by the edges. Do not touch the surface of the CD.

To use the CD-ROM drive, do the following:

- 1** Turn on the computer.
- 2** Push the CD-ROM eject button on the right side of the computer; then pull out the CD-ROM tray.
- 3** Carefully insert your CD-ROM onto the CD-ROM tray; then push the tray into the computer until it fully closes.

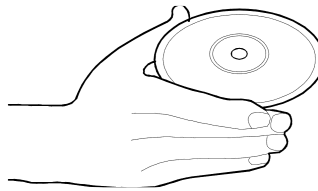

- 4** The way you access the data on the CD-ROM depends on what type of CD it is:
 - Music CDs can be played using the CD Player application program.
 - Data CDs can be read just like normal discs.
 - Photo CDs require specific application software.

Handling Compact Discs

Compact discs are high-density media that must be handled with care and kept clean to ensure that they remain readable. Keep in mind the following to maintain reliability:

Attention:

Wiping the compact disc in a circular direction can cause loss of data.

- Hold the compact disc by the edges. Do not touch the surface of the compact disc.
- To remove dust or fingerprints, wipe the compact disc from the center to the outside of the disc.
- Do not write on the surface.
- Do not store or place the compact disc in direct sunlight.
- Do not use benzene, thinner, or other cleaners to clean the compact disc. Use a CD-ROM cleaner kit.
- Do not flex or bend the compact disc.

Chapter 4. Using Battery Power

This chapter describes the battery-pack operations.

Charging the Battery Pack	4-2
Charging with the AC Adapter	4-2
Battery Pack Maintenance	4-4
Replacing the Battery Pack	4-5
Monitoring the Battery-Power Status	4-7
Using the Battery-Power Status Indicator	4-7
Low Battery Condition	4-8
Using the Fuel-Gauge Icon	4-8
Preserving Battery-Pack Life	4-9
Maximizing Battery-Powered Operation	4-9
Using Advanced Power Management	4-9
Decreasing LCD Brightness	4-11
Using the Battery Power-Management Function	4-12
Display Standby Mode	4-14
Hard Disk Standby Mode	4-14
Standby Mode	4-14
Hibernation Mode	4-15

Charging the Battery Pack

Note:

For more information on maintaining your battery packs, see page 4-4.

The battery pack can be charged with the AC Adapter. You must charge the battery pack in any of the following situations:

- A new battery pack was purchased.
- The battery status indicator (orange) is blinking, and the computer beeps four times.
- The battery status indicator (orange) blinks for less than 1 minute.

Charging with the AC Adapter

Note:

Battery packs shipped from the factory are in an almost-discharged state, so you must charge them fully before use.

The following table shows the approximate charging times for the battery pack:

Conditions	Charging Time
Operational charging	6 to 8 hours
Power-off charging	2 hours

If the battery pack is new or has not been used for a long period of time, it does not reach full charge with only one charging. This is normal. When used regularly (at least once per week) and properly (as described on page 4-4), the battery pack will work its way back up to full capacity within five or six charge and discharge cycles.

Charging the Battery Pack

The following procedure describes how to recharge the battery pack with the AC Adapter when the computer is turned off.

- 1** Turn off the computer; open the battery cover; and install the new or discharged battery pack into the computer.
- 2** Close the battery cover.
- 3** Connect the AC Adapter to the computer.

The system status indicators show the following:

Color	Meaning
Orange	The battery pack is being charged.
Green	The battery pack is fully charged.

Battery Pack Maintenance

Many users are familiar with the phenomenon known as *battery memory*, where after repeated partial charging and discharging the battery pack appears to lose some of all of its original capacity. The nickel/metal-hydride (NiMH) battery packs used by the ThinkPad are less susceptible to memory development than are the more common nickel/cadmium (NiCd) batteries. However, to ensure the longest possible battery life, in terms of both length of use per charge and number of charge and number of charge and discharge cycles before wearing out, please observe the following guidelines:

- Battery packs shipped from the factory are in an almost discharged state, so ***you must charge them fully before use.***
- When charging, always charge the battery pack fully. Even if you only need to run on battery power for a fraction of the battery's capacity, you should not try to give the battery a partial charge.
- Normal charging causes the battery pack to heat up slightly. Let it cool for 15 minutes before you use it.
- Immediately after the battery pack has been drained of power, it may be warm to the touch. This is normal. However, for longer battery life, it should be set aside to cool for 15 minutes before recharging.

Replacing the Battery Pack

When the AC Adapter is connected, you can replace the battery pack whenever it is low in power. Without the AC Adapter, the battery pack can be replaced when the computer power is off, or when the computer is in hibernation mode. To replace the battery pack during hibernation mode and without turning off the computer, follow these instructions.

Important!

To create the hibernation file:



Page 4-15

- If you are using PC Cards, either connect the AC Adapter or stop the PC Card application and remove the PC Card before doing the following.
- Make sure you have created the hibernation file before doing the following steps. Otherwise, you cannot enter hibernation mode. (See page 4-15.)

- 1** Enter hibernation mode by pressing the **Fn+F8** key combination.

Make sure the power-on indicator is off before you open the battery bay door.

- 2** Press the battery cover release latch (1) and slide out (2) the battery cover.

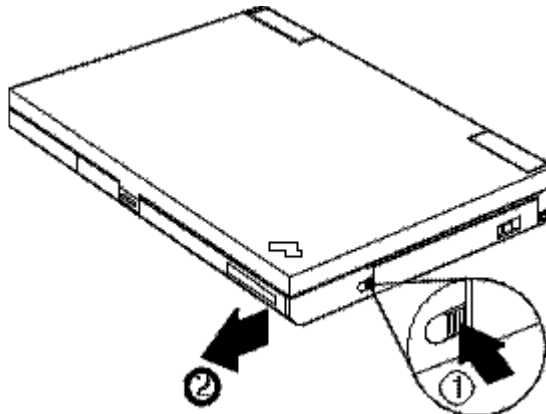

Replacing the Battery Pack

- 3 Locate the pull tab **1** of the battery; pull the tab to remove the battery out of the battery bay.

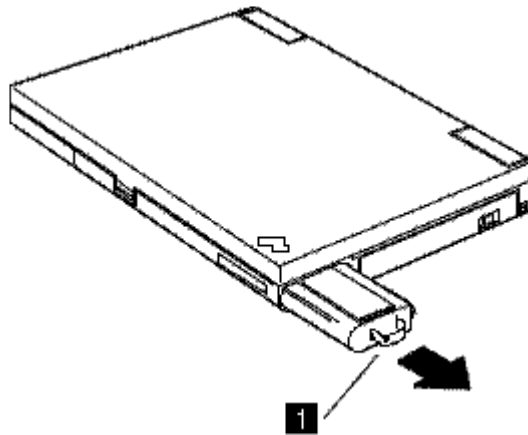

- 4 Insert the fully charged battery into the battery bay (with its connector side up) until you feel the contacts engage.
- 5 Replace the battery bay door.
- 6 Press the power switch.

The computer resumes normal operation from hibernation mode.

Monitoring the Battery-Power Status

The battery condition can be determined through the battery-power status indicator and the Fuel-Gauge icon.

Using the Battery-Power Status Indicator

The battery-power status indicator shows the current status of the battery pack. Observe the battery-power status indicator and compare it with the following status list to determine the battery condition:

Status	Condition	Action Required
Green	Fully charged or partially discharged	Continue your work.
Blinking Orange	Approximately 5 minutes of power left. The orange indicator blinks until power fails or this low-battery condition is remedied.	Take either of the following actions within 1 minute: <ul style="list-style-type: none"> • Connect the AC Adapter to the computer. • Replace the battery pack with a fully charged spare.
Off	The battery pack is not installed, the computer is turned off, or the computer is in hibernation mode.	If standby mode is caused by a low-battery condition, data in memory can be lost. Do either of the following immediately. <ul style="list-style-type: none"> • <i>To continue your work with the AC Adapter:</i> connect the AC Adapter to the computer and press the Fn key. • <i>To continue your work with a fully charged battery pack:</i> connect the AC Adapter to the computer, replace the battery pack with a fully charged one. Then disconnect the AC Adapter from the computer.

Monitoring the Battery-Power Status

Attention:

Do not leave the computer in this condition for an extended period of time. Data in memory will be lost.

For necessary actions:

 Page 4-7.

Low Battery Condition

When the battery pack is low in power, the battery-power status indicator turns amber and begins to blink. At this point, you should complete all disk access operations before the battery runs out of power.

The battery pack needs to be charged immediately. If corrective actions are not taken within 1 minute, the computer enters standby mode or hibernation mode.

Using the Fuel-Gauge Icon

The Fuel-Gauge icon is another way you can monitor the battery pack status. To bring up the Fuel-Gauge icon, press the **Fn+F4** key combination.



The Fuel-Gauge icon shows the current battery charge left in the battery pack. Press the **Fn+Esc** key combination to close the icon.

Preserving Battery-Pack Life

Attention:

Make sure the battery pack power is completely used before you recharge it. Recharging a battery pack that is not completely discharged can shorten battery life.

To preserve the life of the battery pack:

- Do not charge the battery pack until all of its power is used.
- Once you have started charging the battery pack, do not use it until it is fully charged.
- Discharge the battery pack occasionally.
- Turn off the computer whenever it is not in use.

Maximizing Battery-Powered Operation

To save battery power:

- Use Advanced Power Management (APM)
- Decrease the LCD brightness
- Use the Battery Power-Management function

Using Advanced Power Management

Note:

If you have purchase this computer with a preinstalled operating system, APM is already installed correctly.

The computer has power-management functions built in. No special power-management drivers have to be installed before you use the computer. However, the computer is able to conserve more power when Advanced Power Management (APM) is used.

APM allows you to reduce power consumption when your applications and devices are idle. Each operating system comes with its own APM.

Maximizing Battery-Powered Operation



If you are using DOS, you can verify if the computer has APM installed correctly by typing **POWER** at the command prompt and pressing **Enter**. If a screen similar to the following appears, APM is successfully installed.

```
Power Management Status
-----
Setting = ADV : REG
CPU : idle 32% of time.

AC Line Status : OFFLINE

Battery Status : High
```

If not, add the following line to your CONFIG.SYS file, using a text editor such as the DOS Editor.

```
DEVICE=C:\DOS\POWER.EXE
```



If you are using Windows, follow these instructions to check and install APM for Windows:

1. Start the system. Make sure that the current directory is Windows (usually C:\WINDOWS>).
2. Type **SETUP** at the command prompt and press **Enter**. The following screen appears:

```
Windows Setup
=====
If your computer or network appears on the Hardware Compatibility List
with an asterisk next to it, press F1 before continuing.

System Information
Computer:    MS-DOS** System
Display:     XXXXXXXX 800x600 256 small font
Mouse:       Microsoft, or IBM PS/2
```

Note:

If “MS-DOS System with APM” appears for the item “Computer:”, APM is already installed. Press F3 to exit the setup.

3. Using the Arrow keys (↑,↓), position the highlighted cursor on **MS-DOS System** and press **Enter**.
4. Position the highlighted cursor over **MS-DOS System with APM** and press **Enter**.
5. Verify that the item *Computer* has changed to **MS-DOS System with APM** on the screen. If not, return to step 3.

```
Windows Setup
*****
If your computer or network appears on the Hardware Compatibility List
with an asterisk next to it, press F1 before continuing.

System Information
Computer:    MS-DOS System with APM
Display:     XXXXXXXX 800x600 256 small font
Mouse:       Microsoft, or IBM PS/2
```

6. Press **Enter** to install APM.
7. Restart the system to make APM effective.

Decreasing LCD Brightness

Adjust the brightness of the LCD to the lowest level possible that allows you to comfortably view the screen. This is an effective way of conserving battery power.

To adjust the brightness, follow these steps:

- 1 Press the **Fn+F2** key combination to bring up the Contrast pop-up icon.
- 2 Pressing **Fn+F2** again brings up the Brightness pop-up icon. The **Fn+F2** key combination toggles between Brightness and Contrast controls.
- 3 Press the **Fn+←** key combination to decrease the brightness.
- 4 Press the **Fn+Esc** key combination to close the Brightness pop-up icon.

Note:

Contrast can be adjusted only for the DSTN models.

Maximizing Battery-Powered Operation

Using the Battery Power-Management Function

Note:

Sleep Manager needs to be installed to use Hibernation. If Sleep Manager is not yet installed on your computer, see page 7-8 and 7-19 for instructions on how to install Sleep Manager.

Your computer has built-in battery power-saving functions to save power when you use the battery pack or AC Adapter.

When resuming normal operation from one of the modes, use the **resume function** to return to where you were when you entered that mode. Because the operating system is already loaded, the resume function is faster than turning on the power.

The following are the two power-saving modes:

- **Standby mode (Fn+F7).** You can enter standby mode for short idle times, such as when you are taking a short break from work.
- **Hibernation mode (Fn+F8).** You can enter hibernation mode when you leave your office for the day.

It takes more time to return to normal operation from hibernation mode than to return from standby mode, but the computer does not use power.

The following figure shows the operations required when the computer moves from a power-off condition to operation mode, and vice versa.

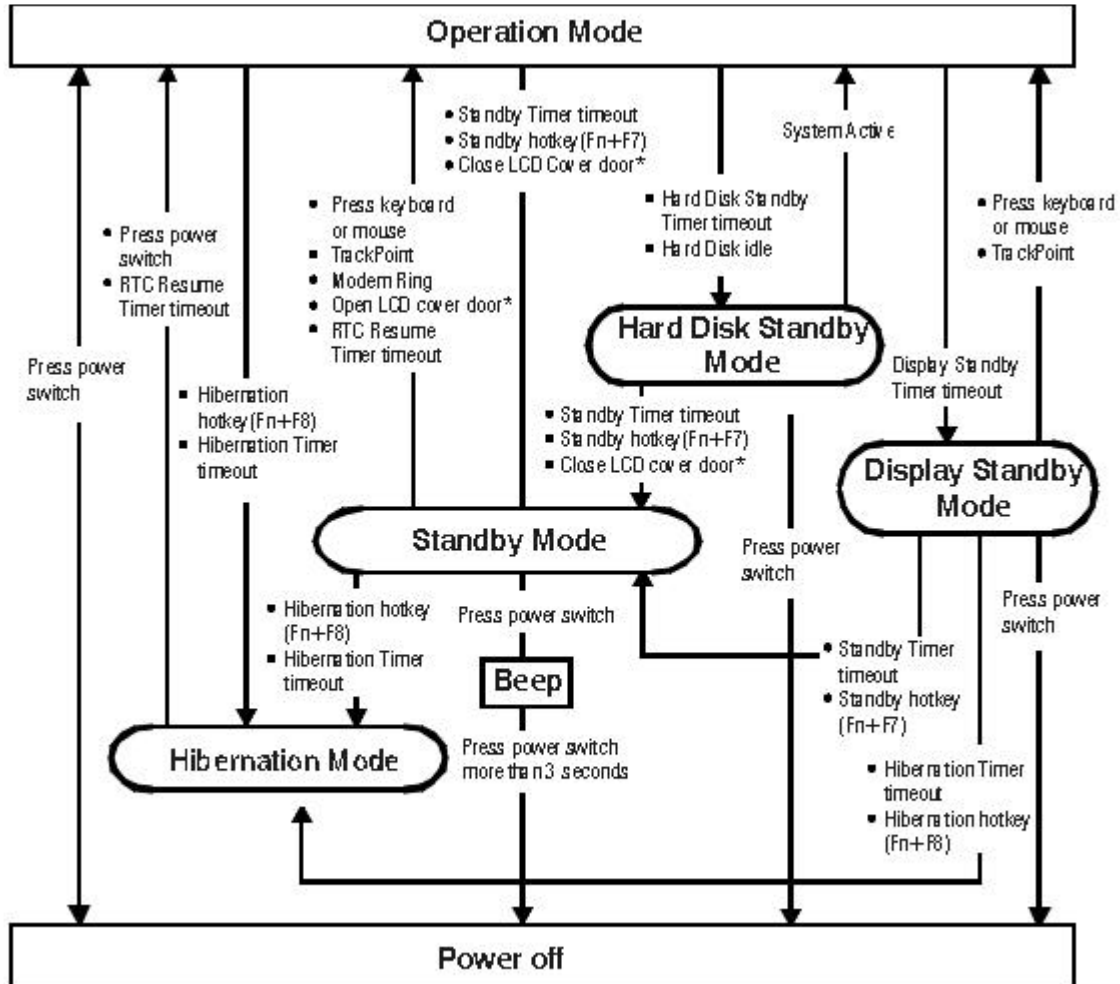

* Should you close LCD cover door to enter Standby mode, please open the LCD cover door to resume your computer.

Using Power Management

Display Standby Mode

In display standby mode, the computer shuts off the LCD backlight and turns off the CRT video as well, if there is no activity from the keyboard, TrackPoint III or external mouse within the period specified by the Display Standby Timer. To turn the display back on, press a key, move the TrackPoint or external mouse.

Hard Disk Standby Mode

In this mode, the hard disk drive spins down and enters a standby state if there are no disk read/write operations within the period specified by the Hard Disk Standby Timer. The hard disk drive automatically powers back on when accessed.

Standby Mode

In standby mode, the hard disk drive stops and the LCD turns off. The computer immediately resumes normal operation when you press any key or use any pointing device. Also, if a power-saving monitor (Energy Star monitor) is in use when the computer enters standby mode, the computer activates the monitor's low-power mode.

Points to Consider When Using Standby Mode

Consider the following before using standby mode:

- The computer enters standby mode if the LCD is closed.
- Pressing the power switch when the computer is in standby mode will not turn off the computer. To turn off the computer, you need to press and hold the power switch for more than 3 seconds.
- When entering standby mode or resuming normal operation with a PC Card, if the application or the computer does not operate, restart the application or the computer.
- When a PC Card is installed, the computer may not enter standby mode.

Hibernation Mode

Notes:

1. Before using hibernation, Sleep Manager (the hibernation utility) must be installed and run.
2. Using a particular PC card can disable hibernation mode.
3. With a base memory of 16MB, it takes approximately 20 seconds to enter hibernation mode and 36 seconds to resume normal operation. (The time to enter or exit hibernation mode depends on the computer memory size.)

In hibernation mode, all tasks are stopped and memory data and the current status of the computer are stored on the hard disk drive; then power is turned off. No battery power is used. When power is turned on again, the computer automatically restores the tasks and resumes normal operation. When the computer enters hibernation mode, you hear one short beep. A graphical message appears; then a short beep sounds again to inform you that the computer has entered hibernation mode.

Attention:

The hibernation file must not be created in a compressed data area of the hard disk.

Creating the Hibernation File

When installing an operating system or installing additional computer memory, you must create a hibernation file on the hard disk drive to use the hibernation mode. (You only need to create the hibernation file once after installing an operating system or additional memory.)

The Sleep Manager program, once installed, automatically creates and manages the hibernation file for you.

The size of the hibernation file will be greater than total memory. For example, if base memory is 16MB and you have installed an optional 16MB memory module (DIMM), the hibernation file is 33MB:

$$(16\text{MB} + 16\text{MB}) + 1\text{MB} = 33\text{MB}$$

The following describes how to create a hibernation file for your operating system.

Using Power Management



If you using Windows 95

- 1 Turn on the computer.
- 2 Click on the **Start** button.
- 3 Select the **Programs** folder.
- 4 Select **Sleep Manager** icon.
- 5 Click on the **Create** button.

Note:

To verify if the hibernation file is valid, you can rest your cursor on the Sleep Manager icon on the taskbar.

If the file is valid, the icon displays **Save-to-disk feature valid**. If the file is invalid, you need to create the hibernation file again.

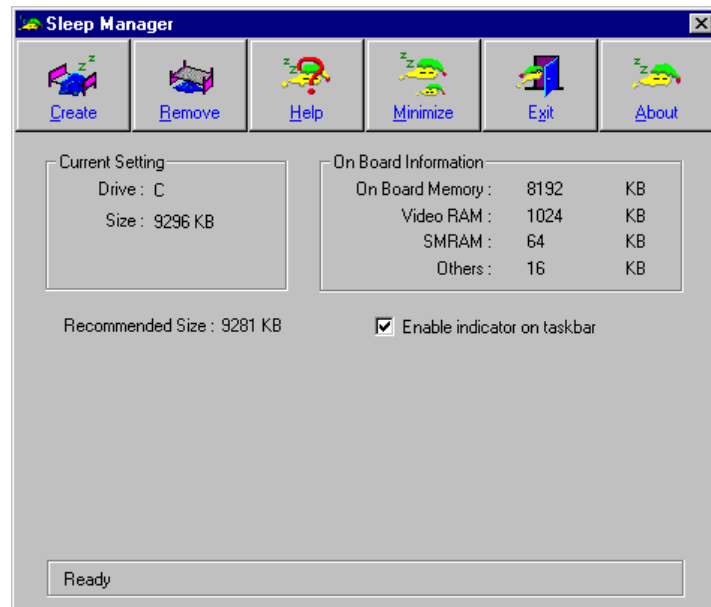

The computer can now enter hibernation mode.



If you are using DOS or Windows

Note:

Sleep Manager for DOS/Windows 3.11 is required. Refer to page 7-8 for instructions on how to install.

- 1** Turn on the computer.
- 2** Type **SLEPMGR /C** at the command prompt; then press **Enter**.

The hibernation file is created on drive C.

Points to Consider When Using Hibernation Mode

Consider the following before using hibernation mode:

- Do not turn off the computer while the hibernation file is being created.
- Create the hibernation file only on the hard disk drive installed in the computer. The hibernation file is read-only.
- The computer reserves some battery power when it is set to enter hibernation mode when a low-battery condition occurs. This can cause the battery operating time to be reduced.
- When entering hibernation mode or resuming normal operation with a PC Card, if the application or the computer does not operate, restart the application or the computer.
- When a PC Card is installed, the computer may not enter hibernation mode.

Note:

If the communication links are still not reestablished, remove and then reinstall the PC Card before restarting the system or application program.

Chapter 5. Protecting Your Computer

This chapter provides information about how to protect your computer and its internal devices.

Using the Power-On Password.....	5-2
Setting the Power-On Password	5-2
Changing the Power-On Password	5-3
Removing the Power-On Password	5-3
Entering the Power-On Password	5-3
Using the Setup Password	5-5
Setting the Setup Password.....	5-5
Changing the Setup Password.....	5-6
Removing a Setup Password.....	5-6
Entering the Setup Password.....	5-6
Using Locks	5-8
Using Locking Devices	5-8
Affixing a Nameplate	5-9

Using the Power-On Password

Note:

If the Setup password is set, you need to enter the Setup password to gain access to the Notebook Manager or BIOS Utility in order to set, change or delete the power-on password.

The Power-On password helps protect your computer from being used by unauthorized persons. If the Power-On password is set, the password prompt appears on the screen whenever you turn on the computer and reminds you to enter the password.

Setting the Power-On Password



If you are using DOS or Windows 3.11, the Power-On password can be set using the BIOS Utility. Refer to “Appendix C, BIOS Utility” for instructions.



If you are using Windows 95, do the following to set the Power-On password:

- 1** Start the Notebook Manager program.
- 2** Select the **Password** tab.
- 3** Click on the checkbox before the Power-On password.
- 4** Type a password into the **Password** text box and press **Enter**.

Note:

When you type a wrong key, use the Backspace key to erase it and then type the correct key.

You can use any combination of up to 7 characters. Use a combination of any letters or numbers (A to Z, 0 to 9) in uppercase (A) or lowercase (a). Uppercase and lowercase letters (for example, A and a) are treated the same.

- 5** Type your password again to verify it; then press **Enter**.
- 6** Click on **OK** to accept.

Do Not Forget Your Password!

Note the password and keep it in a safe place.

If you forget your password, ***you cannot reset it.*** You have to take the computer to an IBM authorized reseller or IBM marketing representative to have the password canceled. Proof of purchase is required, and an additional charge might be required for the service.

Changing the Power-On Password

To change the Power-On password, follow the same steps used in setting a password. The new password will be available the next time you turn on the computer.

Removing the Power-On Password

To delete the Power-On password, leave the Power-On password and confirm text boxes blank; then click on **OK**.

Entering the Power-On Password

Note:

If the return to normal operation is caused by a preset timer or an incoming call through the modem, the password prompt does not appear. To display the prompt, press any key or move your pointing device.

If the Power-On password is set, the password prompt reminds you to enter the password when:

- Turning on the computer.
- Returning to normal operation from hibernation mode.

When the password prompt appears, do the following:

- 1** Type your Power-On password.
 - Each time you press a key, the symbol ■ appears.
 - When typing your password, release each key quickly. If you hold a key down too long, the same letter can be entered repeatedly.

Using the Power-On Password

2 Press the **Enter** key.

- *When the password is entered correctly*, the computer starts normal operation.
- *When you enter the password incorrectly*, **X** appears. Enter the correct password.

If you fail to enter the correct password after three tries, you must turn the computer off, wait at least 5 seconds, and turn it on to try again.

Using the Setup Password

Note:

If the Setup password is set, you need to enter the Setup password to gain access to the Notebook Manager or BIOS Utility in order to change or delete the Setup password.

The Setup password helps you protect classified information. A setup password:

- Secures the system information stored in Notebook Manager and the BIOS Utility.
- Prohibits modification to the hardware.
- Stops the computer after a POST error to restrict access to the system information.

Setting the Setup Password



If you are using DOS or Windows 3.11, the Setup password can be set using the BIOS Utility. Refer to “Appendix C, BIOS Utility” for instructions.



If you are using Windows 95, do the following to set the Setup password:

- 1** Start the Notebook Manager program.
- 2** Select the **Password** tab.
- 3** Click on the checkbox before the Setup password.
- 4** Type a password into the **Password** text box and press **Enter**.

Note:

When you type a wrong key, use the Backspace key to erase it and then type the correct key.

You can use any combination of up to 7 characters. Use a combination of any letters or numbers (A to Z, 0 to 9) in uppercase (A) or lowercase (a). Uppercase and lowercase letters (for example, A and a) are treated the same.

- 5** Type your password again to verify it; then press **Enter**.
- 6** Click on **OK** to accept.

Using the Setup Password

Do Not Forget Your Password!

Note the password and keep it in a safe place.

If you forget your password, **you cannot reset it**. You have to take the computer to an IBM authorized reseller or IBM marketing representative to have the password canceled. Proof of purchase is required, and an additional charge might be required for the service.

Changing the Setup Password

To change the Setup password, follow the same steps used in setting a password. The new password will be available the next time you turn on the computer.

Removing a Setup Password

To delete the Setup password, leave the Setup password and confirm text boxes blank; then click on **OK**.

Entering the Setup Password

If the Setup password is set, the password prompt reminds you to enter the password when:

- Accessing the Notebook Manager.
- Accessing the BIOS Utility (pressing F2 during POST).

When the password prompt appears, do the following:

- 1** Type the Setup password.
 - Each time you press a key, the symbol ■ appears if you are accessing the BIOS Utility. If you are accessing the Notebook Manager, the symbol * appears.

- When typing your password, release each key quickly. If you hold a key down too long, the same letter can be entered repeatedly.

2 Press the **Enter** key.

- *When the password is entered correctly*, the computer starts normal operation.
- *When you enter the password incorrectly*, **X** appears. Enter the correct password.

If you fail to enter the correct password after three tries, the Notebook Manager exits or the computer freezes (if you are accessing the BIOS Utility). Run the Notebook Manager to try again.

Using Locks

Using Locks

Note:

You are responsible for the evaluation, selection, and implementation for the locking devices and security features. IBM makes no comments, judgments, or warranties about the functions, quality, or performance regarding locking devices and security features.

You can protect your computer by attaching locks or a chain, so it cannot be removed without your permission. You can use a lock, such as a Kensington lock, to protect your computer from being removed.

Using Locking Devices

To prevent the removal of your computer, you can purchase a Kensington lock or a compatible lock. Attach the lock to the keyhole on the rear of the computer; then secure the chain on the lock to a stationary object.

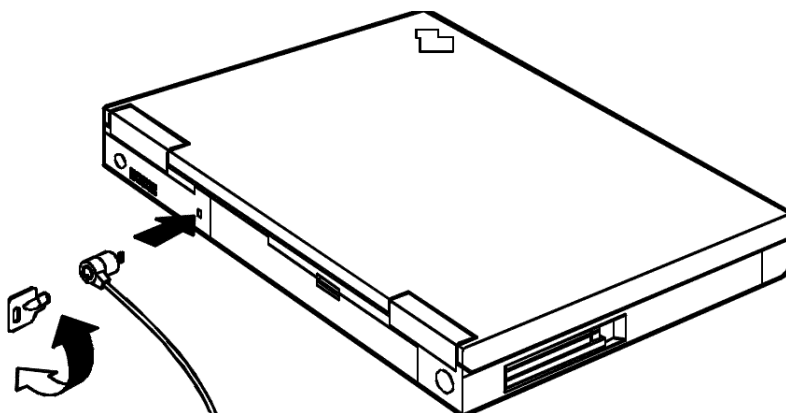

Affixing a Nameplate

On the front of the ThinkPad, a space is provided for a metal nameplate that can be custom engraved with any name, initials, or company name up to 20 characters in length. Among the various materials packaged with your computer, you will find a nameplate brochure card. To receive your nameplate, simply fill out this card and send it in. In a few weeks, the engraved nameplate will be delivered to you.

To affix the nameplate to your ThinkPad, peel off the paper backing to expose the adhesive layer, and press the nameplate firmly into place on the ThinkPad's front panel.

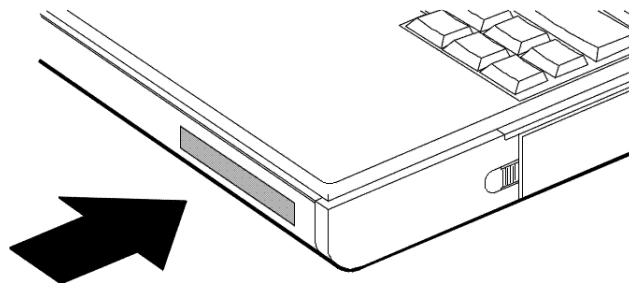

Chapter 6. Installing and Removing Options

This chapter provides information on how to install or remove external or internal devices and IBM options.

Upgrading the Hard Disk Drive	6-2
Installing PC Cards	6-4
Removing PC Cards	6-7
Increasing Memory Capacity	6-8
Installing a DIMM	6-8
Removing a DIMM	6-10
Attaching an External Numeric Keypad or a Mouse	6-11
Attaching an External Keyboard	6-12
Attaching a Printer	6-13

Note

For instructions on installing and removing the battery pack, see page 4-5.



Upgrading the Hard Disk Drive

The ThinkPad 310E/310ED offers you the option to upgrade your existing hard disk drive to a larger capacity drive. This section contains detailed instructions for removing and installing the hard disk drive.

To remove the existing hard disk drive from your computer, do the following:

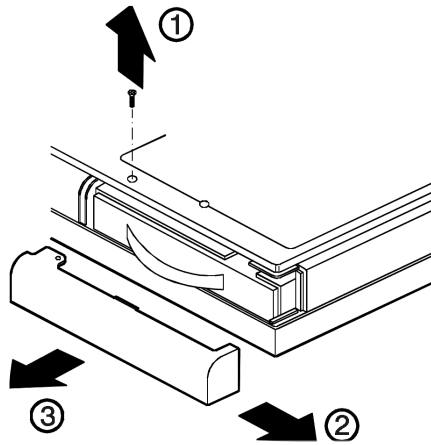
- 1** Turn off the computer.
- 2** Close the LCD.
- 3** Take out the battery pack, if it is installed.
- 4** Turn the computer over on its base.
- 5** Remove the screw  that holds the hard disk drive bay cover in place.



- 6** Slide out  and pull out  to remove the hard disk drive bay cover.

- 7** Pull the hard disk drive out of the hard disk drive bay using the pull tab.

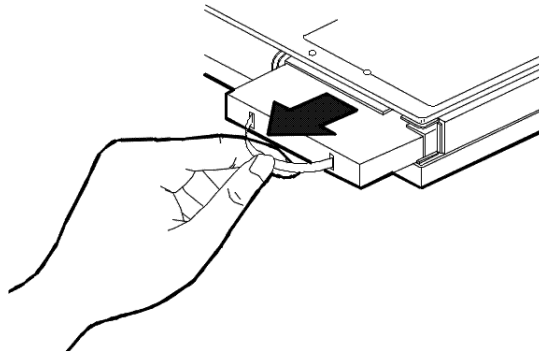

To install the new hard disk drive, do the following:

- 1** Slide the new drive into its bay until you feel the connectors engage.

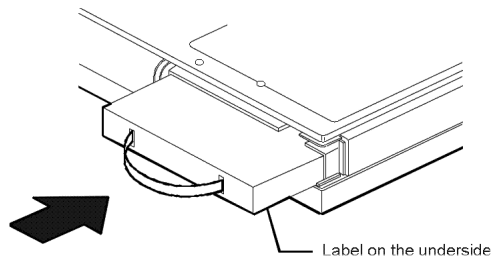

- 2** Reinstall the hard disk drive bay cover.
- 3** Reinstall the screw that holds the bay cover.
- 4** Turn on the computer.

Caution

The hard disk drive is not designed for frequent removal and insertion. This operation is limited to upgrading the hard disk drive capacity.

Installing PC Cards

Your computer has two slots that allow you to plug in credit-card-size PCMCIA cards (called PC cards) that support the PCMCIA Standard release 2.01 or later..

There are different types of PC Cards. Your ThinkPad 310E/310ED supports Type I, Type II, and Type III cards. The PCMCIA slots can be used for the following combinations:

- One or two Type I
- One or two Type II
- One Type I and one Type II
- One Type III

Before Installing PC Cards

Be sure to read "Using PC Cards" on page 3-18.

For information about the type of PC Cards to install, see Appendix B, "Advanced Information for PC Cards".

To install a PC Card in your computer, follow these steps:

- 1** Insert the PC Card into one of the available slots. There is a gentle click when the PC Card has been fully inserted.

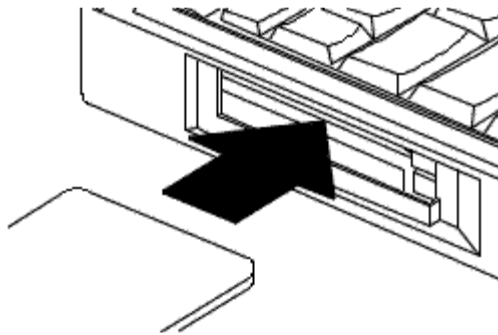

Installing PC Cards

Insert the PC Card with the long row of pin sockets facing the computer and the label on the PC Card facing up. If the PC Card will not fit into the slot, turn the card over. The PC Card can fit into the slot only when inserted the correct way. Do not try to force the card into the slot.

You can insert a Type I or Type II PC Card into either available slot. A Type III PC Card occupies both slots. However, when you insert a Type III card, aim its bottom ridges at the lower PC Card slot.

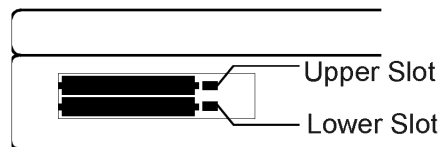

- 2** You can now attach the appropriate devices and cables to your installed PC Card.

To insert an additional Type I or Type II card when one is already installed, follow the same direction, placing the new card into the available slot.

Once you have installed the PC Card, Windows 95 recognizes that a card has been installed and beeps or displays the PC Card window on your screen. From the PC Card icon in the Control Panel, you can configure your PC Card by choosing various settings to be used each time you insert any PC Card or use this particular PC Card. For more information about configuring your PC Card, see "Using PC Cards" on page 3-18.

Installing PC Cards



Important!

The socket status of the lower slot is shown at the top of the socket status panel of Windows 95 as follows. (The status of the upper slot is at the bottom). Be careful when you remove a PC Card.

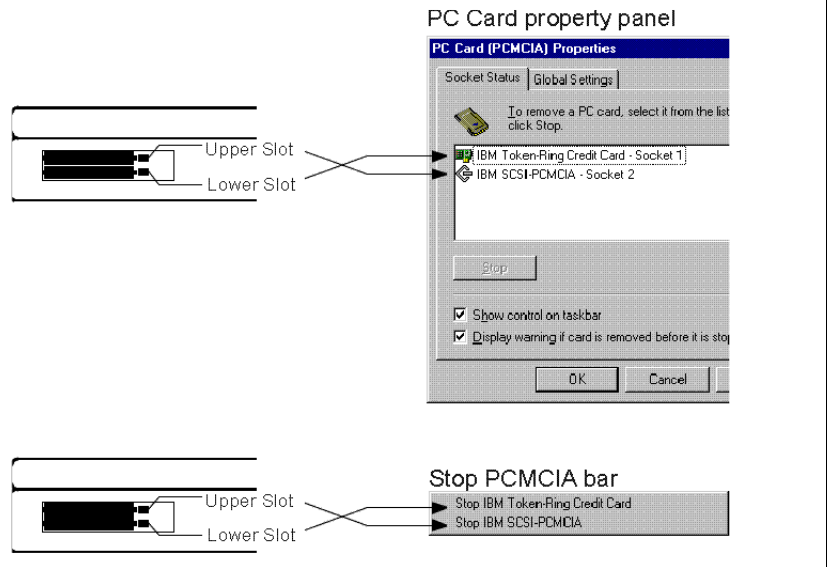



Note:

CardBus Support needs to be enabled in the BIOS Utility to use the ZV port. See page C-12.

Support for ZV (Zoomed Video) port allows your computer to accept PC Cards such as one with hardware MPEG capability. A ZV port PC Card should be inserted into the lower slot. For more information, see page 3-19.

Removing PC Cards

To remove a PC Card from your computer, follow these steps:

- 1** Detach any devices that are connected to your PC Card.
- 2** Pull out  the PC Card release button (if it has been folded into its recessed niche). When it is sticking out straight from the case, press it in gently .

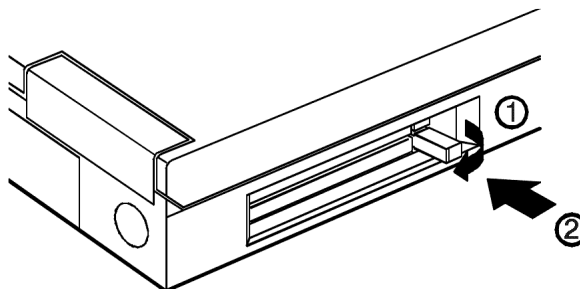

Increasing Memory Capacity

Increasing memory capacity is an effective way to make programs run faster. You can increase the amount of memory in your computer by installing a memory option, called dual inline memory module or DIMM, to increase your computer's memory.

Attention:

To avoid damaging the DIMM, do not touch the contact edge of the DIMM.

Important!

Changing memory while your computer is in hibernation mode may cause permanent damage to the equipment.

Installing a DIMM

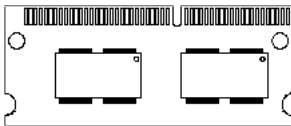

To install the new DIMM, do the following:

- 1** Turn the power off.
- 2** Disconnect all cables and other devices, including the AC adapter.
- 3** Take out the battery pack, if it is installed.
- 4** Turn the computer over on its base.
- 5** Remove the screw ① that holds the memory door in place. Then remove the memory door ②.

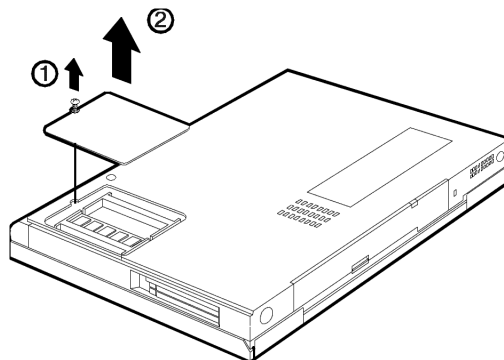

Increasing Memory Capacity

The following figure and table shows the possible memory combinations.

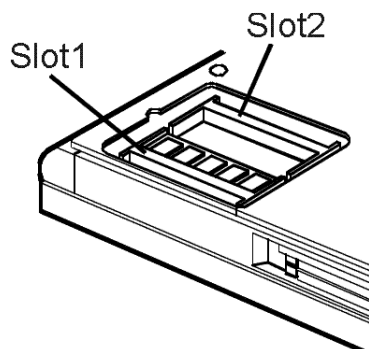

Slot 1	Slot 2
16MB (base)	None
16MB (base)	16MB (option)
16MB (base)	32MB (option)
32MB (option)	32MB (option)

Caution

Do not use any DIMMs other than the IBM ThinkPad 310 DIMMs.

- 6 Position the card at an angle ①, and push it into the socket firmly, aligning the notch in the slot. Then push the module down until it locks into place ②.

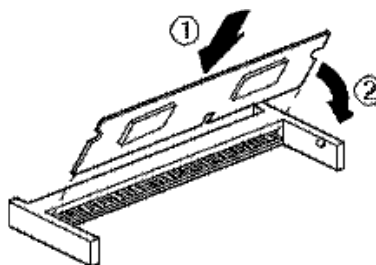

The DIMM should fit into the slot at a slight angle.

Increasing Memory Capacity

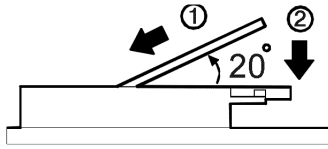

- 7** Reinstall the memory door.
- 8** Reinstall the memory door screw.

Removing a DIMM

To remove a DIMM, do the following

- 1** Turn the power off.
- 2** Disconnect all cables and other devices, including the AC adapter.
- 3** Take out the battery pack, if it is installed.
- 4** Turn the computer over on its base.
- 5** Remove the screw that holds the memory door in place. Then remove the memory door.
- 6** Locate the latches on either end of the DIMM, and pull them gently apart.

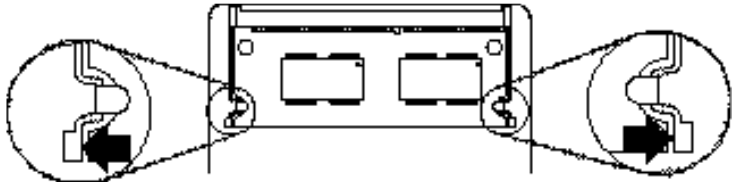

- 7** Lift the DIMM out of its socket.
- 8** Reinstall the memory door.
- 9** Reinstall the memory door screw.

Attaching an External Numeric Keypad or a Mouse

Attention:

When you connect a mouse other than an IBM PS/2 Miniature Mouse, turn off the computer.

An external numeric keypad or a mouse can be attached directly to the external input-device connector at the rear of the computer. You can use both the IBM PS/2 Miniature Mouse and TrackPoint III as the pointing device.

Note:

You can remove the keyboard cover and use it as a stand for the keypad.

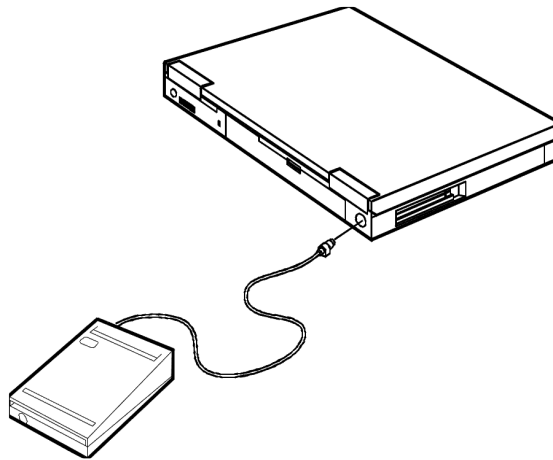

If you want to use the external numeric keypad and mouse at the same time, first connect the keypad cable to the computer; then connect the mouse cable **1** to the connector at the rear of the keypad.

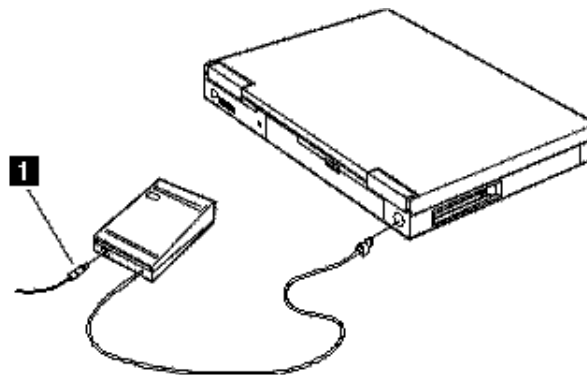

Attaching an External Keyboard

You can connect an external keyboard to your computer either directly through the external input-device connector or through the keyboard/mouse connector (available separately as an option).

Note:

The computer enters standby mode when the LCD is closed.

When the external keyboard is attached, the following keys are not available:

- Numeric keypad on the system keyboard
- External numeric keypad

You should use the numeric keypad on the external keyboard.

When you attach the external keyboard, turn off the computer and then attach the keyboard/mouse connector ① and the external keyboard ②.

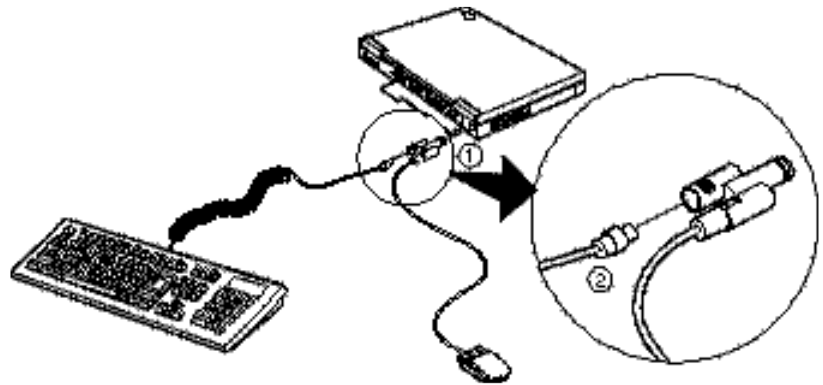

Attaching a Printer

Any parallel printer with the standard Centronics interface can be attached to the 25-pin, parallel connector at the rear of the computer.

- 1** Turn off the computer and attach the printer as shown.

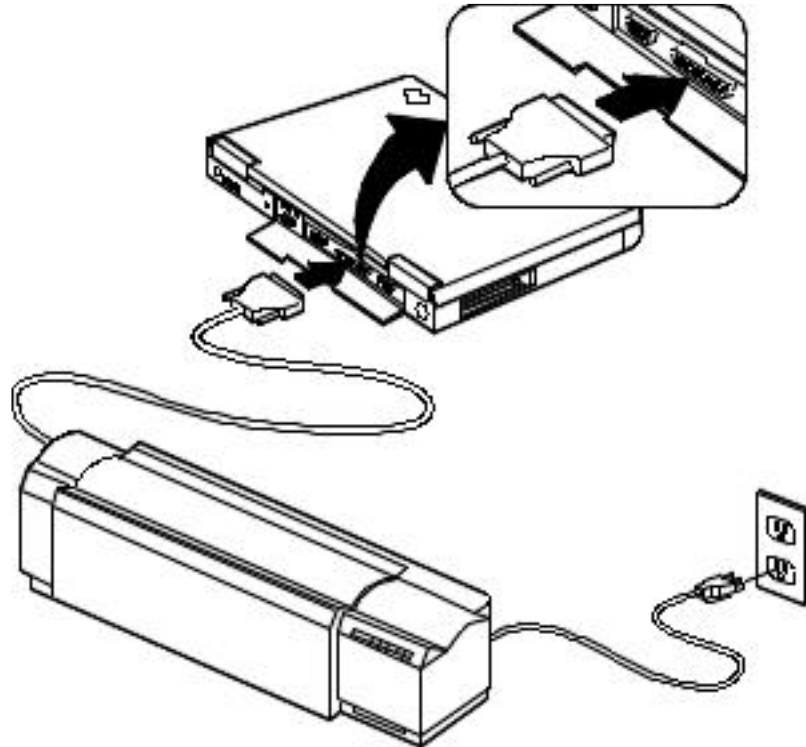

- 2** Turn on the computer and the printer.

Chapter 7. Installing Software

This chapter provides information about the software installed in your computer and the procedures for installing the necessary device drivers when reinstalling an operating system.

What You Need for Your Computer	7-2
Installing the Operating System and Device Drivers	7-3
Accessing Remote Software Services.....	7-4
Creating Installation Diskettes.....	7-5
Installing Software for DOS	7-6
Installing IBM PC DOS Version 7.0	7-7
Installing the CD-ROM Device Driver for DOS	7-7
Installing the Sleep Manager Program for DOS	7-7
Installing the Audio Device Driver for DOS.....	7-8
Installing the PC Card Driver for DOS	7-8
Installing Software for Windows 3.11	7-9
Installing Microsoft Windows 3.11.....	7-10
Installing the Display Driver for Windows 3.11	7-11
Installing the Display Driver.....	7-11
Selecting the Resolution.....	7-11
Installing the PC Card Program for DOS and Windows 3.11.....	7-12
Installing the Audio Support Software for Windows 3.11	7-13
Installing Software for Windows 95	7-14
Installing Microsoft Windows 95	7-15
Installing the Display Driver for Windows 95.....	7-15
Changing the Screen Parameters.....	7-16
Updating the PC Card Driver with Zoomed Video Support....	7-16
Installing the Audio Support Software for Windows 95	7-17
Installing the Audio Driver	7-17
Installing the Audio Software	7-17
Installing the Sleep Manager Program for Windows 95.....	7-18
Installing the Notebook Manager Program.....	7-18
Installing the SafeOFF Program	7-18
Installing the TDial Program	7-19

What You Need for Your Computer

What You Need for Your Computer

Your computer comes with the following software already installed:

- Operating system
- Display driver
- Audio support software
- Notebook Manager program
- Sleep Manager program
- SafeOFF program

Note:

Before reinstalling the operating system and device drivers, you need to create all installation diskettes using the Windows 95 Create System Disks tool. See page 7-5.

When reinstalling an operating system, you must install an operating system and the software listed above for your computer to operate as it did at the time of purchase.

Installing the Operating System and Device Drivers

The operating systems supported by your computer are:

- IBM PC DOS Version 7.0
- Microsoft Windows 3.11
- Microsoft Windows 95

Refer to the appropriate section to install your operating system and its device drivers:



- ***If you are installing DOS:*** go to “Installing Software for DOS” on page 7-6.



- ***If you are installing Windows 3.11:*** go to “Installing Software for Microsoft Windows 3.11” on page 7-9.



- ***If you are installing Windows 95:*** go to “Installing Software for Microsoft Windows 95” on page 7-14.

Accessing Remote Software Services

Before you install these softwares in your computer, you may need to get some update software from IBM as follows:

How to Get the Updated Software

IBM PC Company is providing the updated software through several channels so that you can obtain your software on your computer with the information described here:

- WWW server on the Internet:
<http://www.pc.ibm.com/support.html>
- FTP site:
<ftp://ftp.pc.ibm.com/pub/pccbbs/mobiles>
- CompuServe** ThinkPad Forum:
Join the CompuServe ThinkPad Forum (by entering at the command prompt GO THINKPAD) and download the necessary software from the library.
- IBM PC Company BBS (in the UK):
Phone: 01256-336655

If you cannot get the updated software from any of the preceding channels, contact your IBM representative for more information.

Creating Installation Diskettes

If you need to install your computer with DOS, Windows 3.11 or Windows 95, you need to create installation diskettes for the device drivers and some applications that came with your computer.

Note:

You can only create installation diskettes using the Create System Disks tool in Windows 95.

Prepare formatted diskettes for the installation diskettes you are going to create before proceeding.

To create installation diskettes:

- 1** Click on **Start**.
- 2** Select **Programs**; select **Accessories**; then select **System Tools**.
- 3** Select **Create System Disks**.
- 4** Select the item you want to create installation diskettes for.
- 5** Follow the instructions on the screen to complete the installation.

Repeat steps 4-5 to create additional installation diskettes.

Installing Software for DOS



This section describes the installation procedures for DOS Version 7.0 and its device drivers for your ThinkPad computer.

Important!

Before installing the operating system and device drivers, you need to create all installation diskettes using the Create System Disks program in Windows 95. See page 7-5.

The software shown in the following figure should be installed for your computer to work properly.

Page numbers:

- 1 Page 7-7.
- 2 Page 7-7.
- 3 Page 7-7.
- 4 Page 7-8.
- 5 Page 7-8.

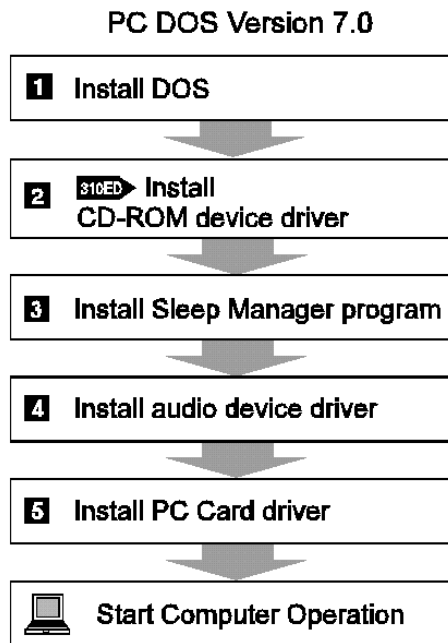

Installing IBM PC DOS Version 7.0

Follow the instructions in the operating-system documentation. If you are also installing Microsoft Windows 3.11, go to “Installing Microsoft Windows Version 3.11” on page 7-10. Otherwise, if you want to continue to install all device drivers, continue with either of the following:

- **310E** “Installing the IDE Driver for DOS”
- **310ED** “Installing the CD-ROM Device Driver for DOS”

Installing the CD-ROM Device Driver for DOS

310ED To install the CD-ROM device driver:

- 1** Start DOS.
- 2** Insert the CD-ROM Driver Diskette for DOS/Windows 3.11 into the diskette drive.
- 3** Type **A:** and press **Enter**.
- 4** Type **INSTALL** and press **Enter**.
- 5** Follow the instructions on the screen to complete the installation.

Installing the Sleep Manager Program for DOS

Note:

You need to install Sleep Manager for your computer to be able to enter hibernation mode. For more information on hibernation mode, see page 4-15.

To install the Sleep Manager program:

- 1** Insert the Sleep Manager Utility Diskette into the diskette drive.
- 2** Type **A:** and press **Enter**.
- 3** Type **INSTALL** and press **Enter**.
- 4** Follow the instructions on the screen to complete the installation.

Installing the Audio Device Driver for DOS

To install the audio device driver:

- 1** Insert the Audio Driver Diskette for DOS/Windows 3.11 into the diskette drive.
- 2** Type **A:** and press **Enter**.
- 3** Type **INSTALL -D** and press **Enter**.
- 4** Follow the instructions on the screen to complete the installation.

Installing the PC Card Driver for DOS

Note:

After installing the PC Card program, you may need to install drivers that come with your PC Card before you can use the PC Card.

You must install the PC Card driver before you can use PC Cards. To install the PC Card driver, do the following:

- 1** Insert the PC Card Program Diskette for DOS into the diskette drive.
- 2** Type **A:** and press **Enter**.
- 3** Type **INSTALL** and press **Enter**.

Installing Software for Windows 3.11



This section describes the installation procedures for Windows Version 3.11 and its device drivers for your ThinkPad.

Important!

Before installing the operating system and device drivers, you need to create all installation diskettes using the Create System Disks program in Windows 95. See page 7-5.

The software shown in the following figure should be installed for your computer to work properly.

Page numbers:

- 1** Page 7-7.
- 2** Page 7-10.
- 3** Page 7-11.
- 4** Page 7-12.
- 5** Page 7-13.

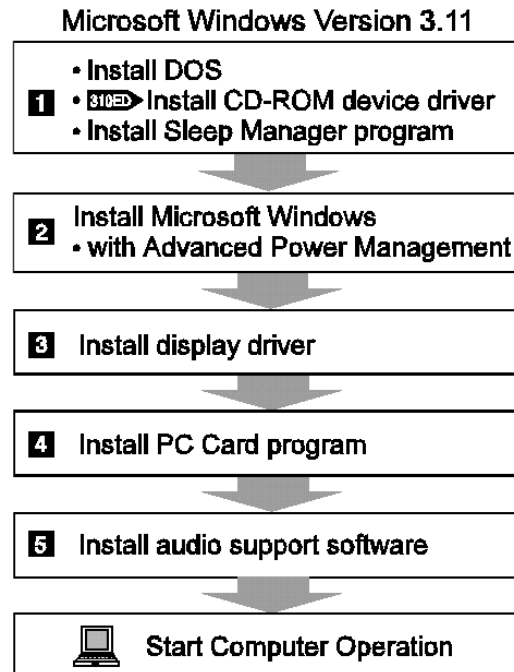

Installing Microsoft Windows 3.11

Windows 3.11 operates in a DOS environment. Install the following before installing Windows:

- DOS Version 7.0 (see your DOS manuals)
- **310ED** CD-ROM Device Driver for DOS (see page 7-7)
- Sleep Manager program for DOS (see page 7-7)

Important!

During installation, do the following for Windows to operate correctly:

- When the Windows Setup program asks you to select either **Express Setup** or **Custom Setup**, select **C** for Custom Setup.
- Install Windows Version 3.11 with the default VGA display driver that came with Windows. After you complete the installation of Windows, install the ThinkPad display driver.

To install Windows 3.11 with Advanced Power Management (APM):

- 1** Turn on the computer.
- 2** Start the installation as specified in the Windows manual.
- 3** When the Windows Setup program asks you to select **Express Setup** or **Custom Setup**, select **C** for Custom Setup.
- 4** Continue installing Windows 3.11 until the following screen appears.

Windows Setup
=====

Setup has determined that your system includes the following hardware and software components. If your computer or network appears on the Hardware Compatibility List with an asterisk, press F1 for Help.

Computer:	MS-DOS System
Display:	VGA
Mouse:	Microsoft, or IBM PS/2

5 Using the Up Arrow, highlight **MS-DOS System** and press **Enter**.

6 Select **MS-DOS System with APM** from the list and press **Enter**.

Verify that **Computer** has changed to **MS-DOS System with APM**. If the item has not changed, return to step 5.

Installing the Display Driver for Windows 3.11

Note:

The display driver should be installed right after you install Windows 3.11.

You must install the display driver to use the various screen resolutions and colors for the LCD and external monitor. (See page 3-16 for possible combinations of resolution and color.) The display driver also takes advantage of the computer's video capability.

Installing the Display Driver

- 1** Insert the Display Driver Diskette for Windows 3.11 into the diskette drive.
- 2** Go to the DOS command prompt **A:** and type **SETUP** to start the display driver setup program.
- 3** Select your language; for example, enter **A** for English setup.
- 4** Press any key; then press **Enter** to select **Windows Version 3.1 (6555X accelerated drivers)**.
- 5** Press **Enter** to select **All Resolutions**; then press **End**.
- 6** Enter your WINDOWS subdirectory and press **Enter** to begin installation.
- 7** Press any key and type **Y** to exit the setup program.

Selecting the Resolution

- 1** Start DOS and go to the WINDOWS subdirectory.
- 2** Type **SETUP** to start Windows setup program.

Installing Software for Windows 3.11

Note:

If you do not know what to choose, try the following: **256 Colors** for the Color palette, **800x600 pixels** for the Desktop area, and **Small Fonts** for the Font size.

3 Using the Up Arrow, highlight **Display** and press **Enter**.

4 Select the desired resolution from the menu and press **Enter**.

Verify that **Display** has changed to your desired resolution (an example is shown in the following screen). If the item has not changed, return to step 3.

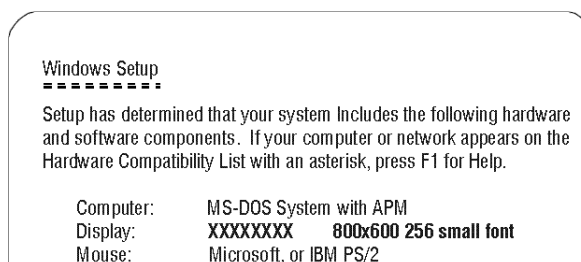

When you start Windows from the DOS prompt, do not close the LCD while the program is loading; if you do, the computer will stop running.

Installing the PC Card Program for DOS and Windows 3.11

Note:

After installing the PC Card program, you may need to install drivers that come with your PC Card before you can use the PC Card.

If you have already installed DOS, you need to install Windows 3.11 before installing the PC Card program.

You must install the PC Card program before you can use PC Cards. To install the PC Card program, do the following:

- 1** Start Windows.
- 2** Select **File...** from the Program Manager window; then select **Run...** from the pull-down menu.
- 3** Insert the PC Card Program Diskette for Windows 3.11 into the diskette drive.
- 4** Type **A:\INSTALL**; then press **Enter**.
- 5** Follow the instructions on the screen to complete the installation.

Installing the Audio Support Software for Windows 3.11

To install the audio support software (Yamaha Station) for Windows 3.11:

- 1** Start DOS.
- 2** Insert the Audio Driver Diskette for DOS/Windows 3.11 into the diskette drive.
- 3** Type **A:** and press **Enter**.
- 4** Type **INSTALL** and press **Enter**.
- 5** Follow the instructions on the screen to complete the installation.

Installing Software for Windows 95



This section describes the installation procedures for Windows 95 and its device drivers for your ThinkPad.

Important!

Before reinstalling the operating system and device drivers, you need to create all installation diskettes using the Create System Disks program in Windows 95. See page 7-5.

The software shown in the following figure is already installed at the time of purchase. When reinstalling Windows 95, install the software for your computer to work as it did.

Page numbers:

- 1 Page 7-15.
- 2 Page 7-15.
- 3 Page 7-16.
- 4 Page 7-17.
- 5 Page 7-18.
- 6 Page 7-18.
- 7 Page 7-18.
- 8 Page 7-19.

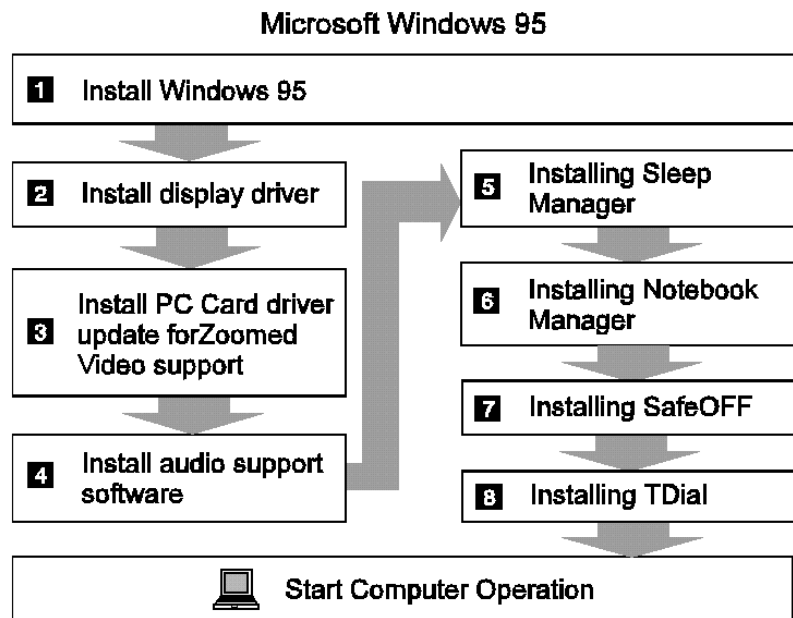

Installing Microsoft Windows 95

Install Windows 95 as described in its documentation.

While Installing Windows 95

During the installation of Windows 95, make sure of the following:

- On the Setup Options screen of the Windows 95 Setup Wizard, select **Custom**; then click on the **Next>** button.
- Follow the instructions on the screen to complete the installation for Windows 95.

For more details, refer to the Windows 95 documentation.

Installing the Display Driver for Windows 95

To install the display driver for Windows 95, do the following:

- 1** Select **My Computer**, **Control Panel**, and then **System**.
- 2** Click on the **Device Manager** tab.
- 3** Click on the + mark for Display adapters; then double-click on (a) **Standard PCI Graphics Adapter(VGA)** or (b) **Chips and Tech. 65550 PCI**.
- 4** Click on the **Driver** tab; then click on **Update Driver....**
- 5** Insert the Display Driver Diskette for Windows 95 into the diskette drive.
- 6** Click on **Yes(Recommended)**; then click on **Next>**.
- 7** Click on **Finish**; then click on **OK**.
- 8** Type **A:** in the *Copy files from:* dialog box and click **OK**.
- 9** Click on **Yes** to restart the computer.

Note:

If any version of the Display Driver is already installed, follow step (b).

You have completed the installation of the display driver.

Changing the Screen Parameters

Note:

If you do not know what to choose, try the following: **256 Colors** for the Color palette, **800x600 pixels** for the Desktop area, and **Small Fonts** for the Font size.

To change the screen parameters, do the following:

- 1** Select **My Computer**, **Control Panel**, and then **Display**.
- 2** Click on the **Settings** tab.
- 3** Select your screen parameters from the Color palette, Desktop area, and Font size; then click **OK**.
- 4** Follow the instructions on the screen.

Updating the PC Card Driver with Zoomed Video Support

To update the PC Card device driver, do the following:

- 1** Insert the Patch Utility Diskette for Windows 95 into the diskette drive.
- 2** Click on **Start**; then click on **Run...**
- 3** Type **A:\PCCARD\PCCARDUP** in the *Run...* dialog box and click **OK**.
- 4** Click on **Yes** to start updating the necessary files.
- 5** Click on **OK** to confirm when the update is complete.

Installing the Audio Support Software for Windows 95

Installing the Audio Driver

To install the audio driver, do the following:

- 1** Select **My Computer**, **Control Panel**, and then **System**.
- 2** Click on the **Device Manager** tab.
- 3** (a) Click on the + mark for Other Devices; then double-click on **OPL3-SA3 Sound Board**, or
(b) Click on the + mark for Sound, video and game controllers; then double-click on **YAMAHA OPL3-SAx Sound System**.
- 4** Click on the **Driver** tab; then click on **Update Driver....**
- 5** Insert the Audio Driver Diskette for Windows 95 into the diskette drive; click on **Yes(Recommended)**; then click on **Next>**.
- 6** Click on **Finish**; then click on **OK**.
- 7** Type **A:** in the *Copy files from:* dialog box and click **OK**.
- 8** Click on **Close**, then **OK** to restart the computer.

Note:

If any version of the Audio Support Software is already installed, follow step (b).

Installing the Audio Software

To install the audio software(Yamaha Station), do the following:

- 1** Insert the Audio Support Software Diskette into the diskette drive.
- 2** Click on **Start**; then click on **Run...**
- 3** Type **A:\WINSTALL** in the *Run...* dialog box and click **OK**.
- 4** Follow the instructions on the screen to complete the installation.

Installing the Sleep Manager Program for Windows 95

Note:

You need to install Sleep Manager for your computer to be able to enter hibernation mode. For more information on hibernation mode, see page 4-15.

To install the Sleep Manager, do the following:

- 1** Insert the Sleep Manager Utility Diskette into the diskette drive.
- 2** Click on **Start**; then click on **Run...**
- 3** Type **A:\SETUP** in the *Run...* dialog box and click **OK**.
- 4** Follow the instructions on the screen to complete the installation.

Installing the Notebook Manager Program

Note:

The Notebook Manager is a system setup program that allows you to set passwords, the startup sequence of drives and power management settings. See page 3-3 for more information.

To install Notebook Manager, do the following:

- 1** Insert the Notebook Manager Diskette for Windows 95 into the diskette drive.
- 2** Click on **Start**; then click on **Run...**
- 3** Type **A:\SETUP** in the *Run...* dialog box and click **OK**.
- 4** Follow the instructions on the screen to complete the installation.

Installing the SafeOFF Program

The SafeOFF provides protection from accidental power off. If you accidentally press the power switch, a dialog box pops up for confirmation. To install SafeOFF, do the following:

- 1** Insert the SafeOFF Utility Diskette for Windows 95 into the diskette drive.
- 2** Click on **Start**; then click on **Run...**
- 3** Type **A:\SETUP** in the *Run...* dialog box and click **OK**.

- 4** Follow the instructions on the screen to complete the installation.

Installing the TDial Program

The TDial program allows your computer to output sound when you are making a call. This program also allows your computer in standby mode to detect an incoming modem ring and wake up. To install the TDial program, do the following:

- 1** Insert the Patch Utility Diskette for Windows 95 into the diskette drive.
- 2** Click on **Start**; then click on **Run...**
- 3** Type **A:\TDIAL\SETUP** in the *Run...* dialog box and click **OK**.
- 4** Click on **Yes** to install the TDial program.
- 5** Remove the Patch Utility Diskette for Windows 95 from the diskette drive and click on **Yes** to restart the computer.

Chapter 8. Solving Computer Problems

Computer problems can be caused by software, hardware, or both. You can diagnose and solve many problems with the assistance of the built-in self-tests. If a hardware problem is detected by the self-tests, an error message is displayed.

You can then identify the problem for the service representative. Make a note of all error codes and give them to the service representative when you call for service. Troubleshooting charts and other information will help you determine what corrective action to take.

Important

Use this chapter to test and diagnose only IBM products. Using the charts on non-IBM products can cause misleading error information or incorrect computer responses. When testing non-IBM products, refer to the instructions supplied with those products.

Frequently Asked Questions and Problems.....	8-2
Troubleshooting Charts.....	8-6
POST Error Codes	8-6
Runtime Error Codes.....	8-9
Getting Service.....	8-10
Recording your Computer Problem.....	8-11
Listing Installed Options	8-12
Recording Identification Numbers.....	8-12
How to Receive Customer Support and Service	8-13
Getting Help by Telephone.....	8-13
ThinkPad EasyServ.....	8-14
Online Housecall	8-14
Getting Information by Fax.....	8-15
Using Electronic Support Services	8-15
Purchasing Additional Services	8-16
Enhanced PC Support Line	8-16
Network and Server Support Line.....	8-17
Ordering Support Line Services	8-17
Warranty and Repair Services	8-18
Obtaining IBM Operating System Updates	8-19
Ordering Publications.....	8-19
About Your Warranty.....	8-19

Frequently Asked Questions and Problems

This section provides:

- Common problems and their corresponding actions.
- Frequently asked questions and their answers.

Questions	Actions
I pressed the power switch but the notebook does not start or boot-up.	<p>Look at the status indicator on the display panel.</p> <ul style="list-style-type: none">• If the indicator is not lit, no power is being applied to the notebook. Check the following:<ul style="list-style-type: none">– If you are running on battery power, it may be low and unable to power the notebook. Connect the AC adapter to recharge the battery pack.– Make sure the AC adapter is plugged in properly to the notebook and to the power outlet.• If the indicator is lit, check the following:<ul style="list-style-type: none">– If the indicator flashes, the notebook is in standby mode. Press any key or move the TrackPoint III to resume.– Is a non-bootable (non-system) diskette in the diskette drive? Remove or replace it with a system diskette and press Ctrl+Alt+Del to restart the system.– The operating system files may be damaged or missing. Insert the startup disk you created during Windows 95 setup into the diskette drive and press Ctrl+Alt+Del to restart the system. This will diagnose your system and make necessary fixes.

Questions	Actions
Nothing appears on the screen.	<p>The notebook's power management system automatically blanks the screen to save power. Just press any key to turn the display back on.</p> <p>If pressing a key does not turn the display back on, two things might be the cause:</p> <ul style="list-style-type: none">• The contrast and/or brightness level might be too low. Press Fn+F2 to bring up the contrast/brightness pop-up icon. Then press Fn+→ to increase the contrast/brightness level.• The display device might be set to an external monitor. Press the display toggle hot key Fn+F3 to toggle the display back to the notebook. <p>Note that if you close the LCD display cover, the computer enters standby mode.</p>
The keyboard does not respond.	<p>Try attaching an external keyboard to the external input-device connector on the rear of the notebook. If it works, contact your dealer or an authorized service center as the internal keyboard cable may be loose.</p>
The serial mouse does not work.	<p>Do the following:</p> <ul style="list-style-type: none">• Make sure that the serial cable is plugged securely into the serial port.• The serial mouse is not a Plug and Play device. You need to use the <i>Add New Hardware</i> tool in Windows 95 to detect and enable the serial mouse.• Press Fn+F6 to enter the BIOS Utility, then press PgDn to see the System Information Reference screen. Check if the serial port is enabled. <p>If the serial port is disabled, turn off the computer and press F2 during POST, then access <i>System Security</i>. Change the <i>Serial Port 1</i> base address parameter setting. See page C-9.</p>

Frequently Asked Questions and Problems

Questions	Actions
The printer does not work.	<p>Do the following:</p> <ul style="list-style-type: none">• Make sure that the printer is connected to a power outlet and it is turned on.• Make sure the printer cable is connected securely to the notebook's parallel port and the corresponding port on the printer.• Press Fn+F6 to enter the BIOS Utility, then press PgDn to see the System Information Reference screen. Check if the parallel port is enabled. <p>If the parallel port is disabled, turn off the computer and press F2 while the ThinkPad logo is being displayed after power-on, then access <i>System Security</i>. Change the <i>Parallel Port</i> base address parameter setting. See page C-9.</p>
No audio comes out from the notebook.	<p>Check the following:</p> <ul style="list-style-type: none">• The volume may be muted. In Windows 95, look at the volume control icon on the taskbar. If it is crossed-out, click on the icon and de-select the <i>Mute</i> option.• The volume level may be too low. Press Fn+F5 to bring up the volume control pop-up icon. Press Fn+→ to increase the volume.• If headphones, earphones or external speakers are connected to the line-out port on the notebook's rear panel, the internal speakers automatically turn off.
The image is not full-screen.	<p>Make sure the resolution is set to 800x600. Right-click on your Windows 95 desktop and select Properties to bring up the Display Properties dialog box. Then click on the Settings tab to make sure the resolution is set to 800x600.</p> <p>640x480 resolution is not full-screen on notebook or on an external monitor.</p>

Frequently Asked Questions and Problems

Questions	Actions
The PC Card does not work.	<p>Check the following:</p> <ul style="list-style-type: none">• Make sure that the PC Card is connected to a PC Card slot.• Make sure that PhoenixCard Manager is installed and works correctly in DOS/Windows 3.11.• Press F2 while the ThinkPad logo is being displayed after power-on to enter the BIOS Utility. Select “System Security” and toggle the “CardBus Support” parameter.• Locate the diagnostics section of the manual that comes with your PC Card and test the PC Card according to these instructions.

Troubleshooting Charts

POST Error Codes

POST error codes display on the screen if results during the POST (Power On Self Test) routines show an error. The computer performs POST while the ThinkPad logo is being displayed on the screen.

Error Codes	Action
010	There is a memory error at MMMM:SSSS:OOOOh (R:xxxxh, W:xxxxh). Have the computer serviced.
011	There is a problem with the system management memory. Have the computer serviced.
013	The computer is loading the SMI (System Management Interface) Handler with APM.
015	The computer battery is critically-low. Connect the AC Adapter to the computer and charge the battery pack, or replace the battery pack with a fully-charged one.
020, 021, 022	Verify that nothing is put on the system keyboard or the external keyboard. Turn off the computer and all attached devices. Turn on the computer first; then turn on the attached devices. If there is still a problem, do the following: <ul style="list-style-type: none">• If the computer has no external keyboard connected, have the computer serviced.• If the computer has an external keyboard connected, do the following:<ul style="list-style-type: none">– Turn off the computer and disconnect the external keyboard; then turn on the computer. If no error occurred, your external keyboard might be damaged. Have the external keyboard serviced.– If you are using the keyboard/mouse connector, verify that it is correctly connected to the computer and that the external keyboard is connected to the correct side of the keyboard/mouse connector (see page 6-13). If the preceding items are correct, disconnect the keyboard/mouse connector from the computer and verify that the operation of the system keyboard is correct. If the system keyboard works correctly, have the keyboard/mouse connector of the external keyboard serviced.

Error Codes	Action
030, 031	<p>Try using the TrackPoint III. If the TrackPoint III does not work, turn off the computer and all attached devices. Turn on the computer first; then turn on the attached devices.</p> <p>If there is still a problem, do the following:</p> <ul style="list-style-type: none"> • If the computer has no external mouse connected, have the computer serviced. • If the computer has an external mouse connected, do the following: <ul style="list-style-type: none"> – Verify that the mouse or pointing-device cable is securely connected to the computer. – If you are using the keyboard/mouse connector, verify that it is correctly connected to the computer and that the external mouse is connected to the correct side of the keyboard/mouse connector (see page 6-13). – If you are using a serial mouse, you need to load a serial mouse driver. <p>If there is still a problem, have the computer serviced.</p>
040	There is a problem with the diskette drive. Have the computer serviced.
045	There is a CPU clock mismatch error. Enter the BIOS Utility, then exit the BIOS Utility. If the problem persists, have the computer serviced.
047, 048	<p>The diskette drive is disabled or write-protected. Do the following:</p> <ol style="list-style-type: none"> 1. Turn off the computer. 2. During POST, press F2 to enter the BIOS Utility. 3. Go to the <i>System Security</i> screen. 4. Change the <i>Diskette Drive</i> control setting to Normal. 5. Exit the BIOS Utility and save the changes.
050	<p>Incorrect connection of the hard disk drive can cause this error codes to appear. This may result in the computer being unable to find the startup drive.</p> <p>Try reconnecting the hard disk drive (see pages 6-2 to 6-3). If the same screen message appears, have the computer serviced.</p>

Troubleshooting Charts

Error Codes	Action
056	<p>There is a problem with the hard disk drive auto-detect function. Do the following:</p> <ul style="list-style-type: none">• Incorrect connection of the hard disk drive can cause this error codes to appear.<ul style="list-style-type: none">– Turn off the computer and try reconnecting the hard disk drive (see pages 6-2 to 6-3). Then turn on the computer.• Verify the Auto-detect setting of the hard disk drive.<ul style="list-style-type: none">– Reboot the computer and press F2 during POST to enter the BIOS Utility.– Access the <i>Basic System Settings</i> screen and set the <i>Hard Disk Drive</i> parameter to <i>Auto</i>.– Exit BIOS Utility and save the changes. <p>If the same screen message appears, have the computer serviced.</p>
054, 055	<p>The hard disk drive is disabled or write-protected. Do the following:</p> <ol style="list-style-type: none">1. Turn off the computer.2. During POST, press F2 to enter the BIOS Utility.3. Go to the <i>System Security</i> screen.4. Change the <i>Hard Disk Drive</i> control setting to <i>Normal</i>.5. Exit the BIOS Utility and save the changes.
070	<p>There is a problem with the real-time clock. Have the computer serviced.</p>
071, 072	<p>There is a problem with the CMOS. Have the computer serviced.</p>
081	<p>There is a system resource conflict. Do the following:</p> <ol style="list-style-type: none">1. Turn off the computer.2. During POST, press F2 to enter the BIOS Utility.3. Go to the <i>System Security</i> screen and make sure no I/O addresses are shared by two devices.4. Exit the BIOS Utility and save the changes. <p>If the problem persists, have the computer serviced.</p>

Error Codes	Action
082	<p>There is an IRQ (interrupt request) conflict. Do the following:</p> <ol style="list-style-type: none"> 1. Turn off the computer. 2. During POST, press F2 to enter the BIOS Utility. 3. Go to the <i>System Security</i> screen and make sure no IRQs are shared by two devices. 4. Exit the BIOS Utility and save the changes. <p>If the problem persists, have the computer serviced.</p>
246	<p>There is a device configuration error. Enter the BIOS Utility and verify the problem, then exit the BIOS Utility. If the problem persists, have the computer serviced.</p>

Runtime Error Codes

Runtime error codes display on the screen while the computer is being used.

Error Codes	Action
102	<p>There is a problem with I/O parity. Have the computer serviced.</p>
103	<p>There is an NMI (Non-Maskable Interrupt) problem with the computer. Press Esc to turn off NMI or any other key to reboot the computer.</p> <p>If the problem persists, have the computer serviced.</p>
104	<p>You need to reboot your computer. Insert a bootable diskette into the diskette drive and press Enter to reboot.</p>

Getting Service

Getting Service

If you need further assistance, call your IBM authorized reseller or IBM marketing representative.

When requesting service, describe the error message or problem to the service representative. Error messages can help identify what service action is required and help the service representative provide quick and efficient service.

Important

During the warranty period, you may be responsible for repair costs if the product damage was due to misuse, accident, modification, unsuitable physical or operating environment, or improper maintenance by you.

For your convenience, write the service phone numbers here:

Recording your Computer Problem

Use this sheet for your problem reporting.

- Computer information:

Machine type: _____

Serial number: _____

Date of purchase: __/__/__

- A kind of problem:

Continuous problem Intermittent problem

- Error code:

- Operating systems and their version if available:

DOS Version _____

Windows 3.1

Windows 95

- Used application programs at the time of the problem:

- Problem symptom:

Describe the problem more specifically.

Reproducibility:

Yes No

Describe how to reproduce it:

Getting Service

Listing Installed Options

When requesting repair service, you might need to know which options you have in your system. Check or write the names of your options below.

- | | |
|---|---------------------------------------|
| <input type="checkbox"/> DIMM (16MB or 32MB) | <input type="checkbox"/> Battery pack |
| <input type="checkbox"/> _____MB Hard Disk Drive | <input type="checkbox"/> PC Cards |
| <input type="checkbox"/> Internal CD-ROM Drive or
Diskette Drive | _____
_____ |

Recording Identification Numbers

The following information is needed when requesting repair services:

IBM Product Name	<input type="checkbox"/> IBM ThinkPad 310E <input type="checkbox"/> IBM ThinkPad 310ED
Machine Type	_____
Serial Number	_____

The machine type and serial number **1** are located on the bottom of the computer.

- The machine type has a prefix of **Type**.
- The serial number has a prefix of **S/N**.

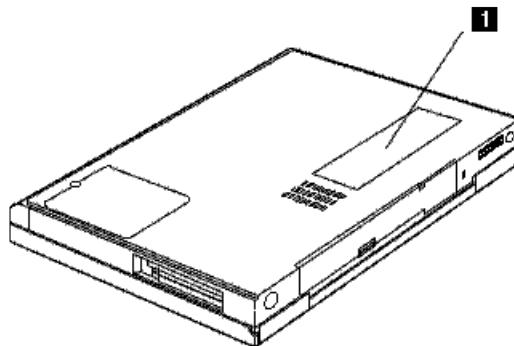

How to Receive Customer Support and Service

Purchasing an IBM PC hardware product entitles you to help and support during the warranty period. If you need additional support and services, a wide variety of extended solutions that address almost any need are available for purchase.

Getting Help by Telephone

During the warranty period, you can get help and information by telephone, at no additional charge, through the IBM PC Support Line. Expert technical-support representatives are available to assist you with questions you might have on the following:

- Setting up your computer
- Installing and setting up IBM options purchased from IBM or an IBM reseller
- Using the 30-day support for the preloaded operating system
- Arranging for service

Please have the following information ready when you call:

- Serial number of your computer and your proof of purchase
- Description of the problem
- Exact wording of any error messages
- Hardware and software configuration information for your system

If possible, be at your computer when you call.

- In the U.S. and Puerto Rico, call 1-800-772-2227.
- In Canada, call 1-800-565-3344.

These services are available 24 hours a day, 7 days a week. Your technical-support representative can also fax or mail additional technical or product information to you, such as:

- Sales information
- Product brochures
- Locations of IBM resellers
- Services available through IBM

ThinkPad EasyServ

ThinkPad EasyServ is a courier repair service for IBM mobile products wherein your ThinkPad computer will be picked up, sent to IBM for repair, and then returned to the location of your choice. This service is available at no additional charge during the warranty period. Most repairs should be made the same day the system is received at the IBM repair location.

You can arrange this service by calling the PC Support Line for service. Telephone problem determination will be performed in the event the issue may be resolved over the telephone. If the problem cannot be resolved over the telephone, a support representative can arrange for ThinkPad EasyServ.

You should keep your original ThinkPad shipping materials to send the computer to the repair location. If the original shipping carton is not available, the courier will deliver a shipping carton and return to pick up the system for delivery to IBM. This service is available only in the U.S. and Canada.

Online Housecall

Online Housecall is a remote communication tool, that allows an IBM technical-support representative to access your PC by modem. Many problems can be diagnosed remotely and corrected quickly and easily. To use this tool, a modem and a remote access application program are required. There may be a charge for this service.

For more information about configuring your PC for Online Housecall in the U.S. or Canada:

- In the U.S., call 1-800-722-2227.
- In Canada, call 1-800-565-3344.

Getting Information by Fax

In the U.S. and Canada, if you have a touch-tone telephone and access to a fax machine, you can receive by fax free marketing and technical information on many topics, including hardware, operating systems, and local area networks (LANs). You can call the IBM PC Company Automated Fax System 24 hours a day, 7 days a week. Follow the recorded instructions, and the requested information will be sent to your fax machine.

To access the IBM PC Company Automated Fax System, do the following.

- In the U.S., call 1-800-426-3395.
- In Canada, call 1-800-465-3299.

Using Electronic Support Services

If you have a modem, you can access public electronic bulletin boards and public messaging areas, electronic conferences, and searchable databases available in several of the most popular online information services.

Bulletin boards and online services contain information on many topics, such as:

- PC user groups
- PC questions and answers
- Solving problems
- Technical information
- Hardware and software configurations
- Networking

The IBM PC Company Bulletin Board System (BBS) can be reached 24 hours a day, 7 days a week. Modem speeds of up to 14,400 baud are supported. Long distance telephone charges may apply.

Customer Support and Service

To access the PC Company BBS:

- In the U.S., call 1-919-517-0001.
- In Canada, call the center closes to you:
 - Markham: call 905-316-4255.
 - Montreal: call 514-938-3022.
 - Toronto: call 416-492-1823.
 - Vancouver: call 604-664-6466.

Commercial online services that contain information about IBM products include:

- CompuServe**
Use the following GO word: ThinkPad.
- PRODIGY**
Use the **Jump** command; type IBM and select **PC Product Support**.
- America Online**
Use the **Go to** keyword **IBM**.

Purchasing Additional Services

During and after the warranty period, you can purchase additional services, such as support for IBM and non-IBM hardware, operating systems, and application programs; network setup and configuration; upgraded or extended hardware repair services; and custom installations. Service availability and name might vary by country.

Enhanced PC Support Line

Enhanced PC Support is available for desktop and mobile IBM computer that are not connected to a network. Technical support is provided for IBM computers and IBM or non-IBM options, operating systems, and application programs on the Supported Products list.

This service includes technical support for:

- Installing and configuring your out-of-warranty IBM computer
- Installing and configuring your non-IBM options in IBM computers

- Using the preloaded operating system
- Using selected application software and games
- Tuning performance
- Installing device drivers remotely
- Setting up and using multimedia devices
- Identifying system problems
- Interpreting documentation

You can purchase this service for a single incident or multiple incidents. For more information about purchasing Enhanced PC Support, see “Ordering Support Line Services” on page 8-17.

Network and Server Support Line

Network and Server Support includes all the features of the Enhanced PC Support Line and is available for simple or complex networks made up of IBM workstations and servers using major network operating systems. In addition, many popular non-IBM adapters and network interface cards are supported.

This service includes technical support for:

- Installing and configuring client workstations and servers
- Identifying system problems and correcting problems on the client or the server
- Using IBM and non-IBM network operating systems
- Interpreting documentation

You can purchase this service for a single incident or for multiple incidents. For more information about purchasing Network and Server Support, see “Ordering Support Line Services”.

Ordering Support Line Services

Enhanced PC Support Line and Network and Server Support Line services are available for products on the Supported Products list. To receive a Supported Products list:

- In the U.S.,
 - Call 1-800-772-2227.
 - Select the automated fax system option.

Customer Support and Service

- Select the service for which you would like a Supported Products list:
 - For Enhanced PC Support Line, select document 11682.
 - For Network and Server Support Line, select document 11683.
- In Canada, contact IBM Direct at 1-800-465-7999, or:
 - Call 1-800-465-3299.
- In all other countries, contact your IBM reseller or IBM marketing representative.

For more information or to purchase these services:

- In the U.S., call 1-800-772-2227.
- In Canada, call 1-800-465-7999.
- In all other countries, contact your IBM reseller or IBM marketing representative.

Warranty and Repair Services

You can upgrade your ThinkPad EasyServ/Customer Carry-in warranty service or extend the service beyond the warranty period.

Warranty upgrades in the U.S. include:

- Overnight service option

Your warranty provides ThinkPad EasyServ/Carry-in repair

You can also extend your warranty. Warranty and Repair Services offers a ThinkPad EasyServ Maintenance Agreement.

For more information about warranty upgrades and extensions:

- In the U.S., call 1-800-426-7697.
- In Canada, call 1-800-465-7999.
- In all other countries, contact your IBM reseller or IBM marketing representative.

Obtaining IBM Operating System Updates

IBM provides update diskettes, called ServicePaks or corrective service diskettes (CSDs), to customers who report a DOS problem for which there is or will be a corrective program.

You can obtain update diskettes from the following sources:

- IBM PC Company BBS
- IBM Software Solutions Center. In the U.S. or Canada, call 1-800-992-4777.
- IBM authorized reseller or IBM marketing representative.

Ordering Publications

Additional publications are available for purchase from IBM. For a list of publications available in your country:

- In the U.S. and Puerto Rico, call IBM PC Books at 1-800-426-7282.
- In Canada, call 1-800-465-1234.
- In all other countries, contact your IBM reseller or IBM marketing representative.

About Your Warranty

During the warranty period, you may be responsible for repair costs if the product damage was due to misuse, accident, modification, unsuitable physical or operating environment, or improper maintenance.

For complete details about the product warranty, see Appendix E.

Appendix A. Avoiding Hardware Conflicts

This appendix describes how to avoid system resource conflicts by listing the default and optional hardware settings.

Avoiding System Resource Conflicts

When a new option such as an adapter card is installed, the computer might not operate correctly because of conflicting settings for IRQ (interrupt) levels, I/O addresses, DMA channels, and memory addresses.

To avoid these resource conflicts, you must know the hardware requirements, such as IRQ level and I/O addresses, for each option and program as shown in their manuals.

Notes:

For resolving system resource conflicts with PC Cards, see Appendix B.

Then you must check the current resource allocations for the computer, and select the available resource values by using the BIOS Utility. See Appendix C.



To check if there is a resource conflict in Windows 95, do the following:

- 1** Select **My Computer**, **Control Panel**, and then **System**.
- 2** Click on the **Device Manager** tab.

Check the list for devices with resource conflicts. A ! symbol shows in front of these devices. If there are devices with resource conflicts, double-click on the device and click on the **Resource** tab.

Read the **Conflicting device list** for any resource conflicts. If there is a resource conflict, re-assign the device to an available and valid resource (see page A-2).

- 3** Close the **System** window.

List of System Resources

List of System Resources

The following table summarizes the available system resources for the computer. Values in parentheses are alternative values that are selectable in the BIOS Utility or application programs. The default values are highlighted.

System Resources	IRQ	I/O Address (Hex)	Memory Address (Hex)	DMA Channel
Timer	0	0040-0043 and 0048-004B	None	None
Keyboard	1	0060 and 0064	None	None
Serial Port	4	03F8-03FF	None	None
	3	02F8-02FF		
	4	03E8-03EF		
	3	02E8-02EF		
	Disabled	Disabled		
Parallel Port	7	03BC-03BE	None	None
	7	0378-037F		
	5	0278-027F		
	Disabled	Disabled		
Diskette Controller	6	03F0-03F7	None	2
Video Controller	None	03B4, 03B4-03B5, 03C0-03CF, 03D0-03DF	0A0000-0BFFFF and 0C0000-0CBFFF	None
Audio Controller Device (Sound Blaster)	5, 7, 9, 10 or 11	0220-022F or 0240-024F	None	0, 1 or 3
Audio Controller Device (FM Synthesizer)	None	0100-0101 or 0370-0371	None	None
Audio Controller Device (Windows Sound System)	None	0530-0537 or 0E80-0E87	None	None

List of System Resources

System Resources	IRQ	I/O Address (Hex)	Memory Address (Hex)	DMA Channel
Hard Disk Drive	14	01F0-01F7 and 03F6, F000-F007	None	None
CD-ROM Drive	15 ¹	0170-0177 and 0376, F008-F00F	None	None
PCMCIA Controller (CardBus)	10 and 11	None	None	None
PCMCIA Controller (PC Card 16)	10 or 11	03E0-03E1	None	None
PC Card	(Depends on the type of PC Card)	(Depends on the type of PC Card)	(Depends on the type of PC Card)	None
Note: 1. The IRQ for CD-ROM is fixed at 15.				

Appendix B. Advanced Information for PC Cards

This appendix describes advanced information related to using PC Cards in DOS and Windows 3.11.

Important!

If you are using a PC Card for the first time, you need to install the client driver provided by the PC Card vendor that is included with the PC Card you purchased. Your computer should be installed with PhoenixCard Manager before you install the client driver for PhoenixCard Manager to correctly identify the PC Card.

A PC Card which is not compatible with Phoenix's PCMCIA driver will not run on your computer.

Phoenix Card Manager

The PhoenixCard Manager includes programs and utilities that help you manage and configure your PC Cards for use with your computer. These include the following:

- PCMS Setup For Windows

Enables you to add features that you originally did not select when you first installed PhoenixCard Manager and diagnose PC Cards.

- EPD Utility

Automatically loaded on Windows startup, the Event Processor Daemon (EPD) runs in the background and monitors all events related to the PC Card sockets in your computer such as card insertions/extractions, card configuration success/failures, card event-action associations, and programs launched. EPD records these events in the Event Log, which you can easily access, review and print.

- PCMRman For DOS

This DOS-based utility allows you to review and allocate resources, such as IRQ, I/O ranges, Memory ranges and DMA channels. The PCM install program automatically installs an icon for PCMRMAN.EXE in the CardAgent group window.

- CardAgent Utility

In most cases, the CardAgent Utility automatically configures any PCMCIA-compliant card. All you have to do is merely insert the card into the socket in your computer. When a card cannot be automatically configured, the CardAgent Utility enables you to allocate resources to make the card functional.

PCMSetup For Windows

PCMSetup is a utility that enables you to:

- Configure your computer to optimize its performance.
- Customize the CardAgent software to maximize its functionality.
- Select PC Card options that you did not originally select when you first installed PCM.

Adding Options

If you want to add support for PC Cards that you originally did not specify when you first installed PCM, do the following:

- 1** Click on **Options** or press **Alt-O**.
- 2** Enable the options (described below) that you need by clicking on the appropriate checkbox.
 - *Flash*. Enable this option if you plan to use flash cards.
 - *ATA*. Enable this option if you plan to use ATA cards.

When the option is enabled, an “**X**” appears in the box. When you disable the option, the box is empty.

Specifying a Fax/Modem Communications Port

To specify a communications port for your fax/modem card, do the following:

- 1** Double-click on **PCMSetup For Windows** in the PhoenixCard Manager program group.
- 2** Click on **Defaults** or press **Alt-D**.

- 3 Click on **Modem Port**. The Modem Communications Port dialog box appears.

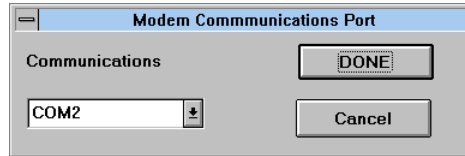

- 4 Click on the down arrow to open the drop down menu, and select the appropriate COM Port (1, 2, 3 or 4). Make sure there are no conflicts with other devices on your computer that are using a communications port.
- 5 Click on **DONE** when you have specified the default communications port, or click on **Cancel** to exit without saving the communications port specification.

When a port assignment error occurs, an error message “Invalid port entered. Please try again, or press CANCEL.” appears. Please try another port.

Specifying the Flash File System Path

To specify the complete path to the directory that contains your Flash File System files, do the following:

- 1 Double-click on **PCMS_{etup} For Windows** in the PhoenixCard Manager program group.
- 2 Click on **Defaults** or press **Alt-D**.
- 3 Click on **Flash Path**. The Flash File System Path dialog box appears.

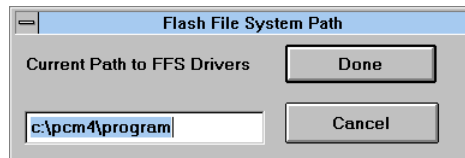

- 4** Type in the complete path to the directory that contains the Flash File System drivers for your Flash card.
- 5** When you have entered the Flash File System path, click on **Done**, or click on **Cancel** to exit without saving the FFS path designation.

When a path designation error occurs, an error message “Invalid path entered. Please try again, or press CANCEL.” appears. Please set the correct path.

Setting Advanced Options

The Advanced menu contains options that are intended for experienced and advanced computer users. The default settings should suffice for most systems and users. However, there may be occasions when you must change these settings to resolve conflicts. To activate the Advanced dialog box, use your mouse to click on Advanced, or press **Alt-A**.

The Advanced dialog box allows you to specify values for the following resources:

IRQ

Note:

PCM automatically detects the Socket Controller installed in your computer. For each controller that PCM supports, there is a corresponding default IRQ.

You have the option of specifying an IRQ, with a value ranging from 0 to 15. Be sure that you do not assign two devices to the same IRQ, or an error will result.

Refer to your computer’s documentation to determine the IRQ you should specify for your computer.

CIS Address

This option allows you to store a PC Card’s CIS, which stands for Card Information Structure, at a specific location in memory.

The default CIS address should suffice for most PC cards. However, if the card you are using requires a specific address (see your card manufacturer’s accompanying documentation), then you must enter the address in this field.

Card Settling Time

The default value should suffice for most PCMCIA-compliant cards. However, if the manufacturer of the card you are using suggests a different value, enter that value here.

ATA and Flash Card Options

Additionally, you can optimize your use of ATA and FLASH cards when you specify these values:

- Memory Base
- Window Size
- Spin Down Time
- Partitions
- Erase Queues

The default ATA and Flash settings should suffice for most computers and users. However, there may be occasions when you must change these options.

Event Processor Daemon (EPD) Utility

The Event Processor Daemon (EPD) is the central control for the Phoenix Card Agent. It runs in the background along with your other Windows programs and monitors all aspects of your PC Card sockets. It is responsible for ensuring that every attempt is made to successfully configure your PC Cards, and in the event of a failure, it along with other Phoenix Card Manager components, help you to diagnose the failure and apply countermeasures in an effort to make your PC Card operative.

Normally, the EPD does not interact directly with you, the user; instead, if you need to view, control, modify, analyze, or otherwise understand your PC Card sockets, use the CardAgent Utility described on page B-10.

PCMRman For DOS

PCMRman allows you to modify the available resources of your computer. You can modify the settings for available reserved memory addresses, I/O, IRQ and DMA settings. Conflicting settings for these items can cause your computer to operate improperly. For this reason, great care should be taken before modifying any of the current settings.

Displaying Resources

Follow these steps to display resource usage:

- 1** Press **Alt-D** to pull down the Display menu.
- 2** Press **↑** and **↓** to choose the desired resource information to display; then press **Enter**.

Modifying Resources

Follow these steps to modify resource settings:

- 1** Press **Alt-M** to pull down the Modify menu.
- 2** Press **↑** and **↓** to choose the desired resource information to modify; then press **Enter**.
- 3** Modify the resource:
 - for Memory Ranges, IRQ Number and DMA Channels
Press **↑** and **↓** to choose the desired memory range, IRQ number or DMA channel to modify; then press **Space** to change the setting (None, Included or Excluded) and press **Enter** to accept.

- for I/O Ranges

Type in the Start Range for the selected I/O address and then press **Tab**; type in the End Range and press **Enter** to accept. The Start and End ranges should be within the selected I/O address range.

- 4** Press **Alt-F** to pull down the File menu.
- 5** Press **↑** and **↓** to choose Save Configuration; then press **Enter**.
- 6** When a dialog box “Save Configuration To INI File?” appears, press **↓** to choose Yes; then press **Enter**.

CardAgent Utility

The CardAgent Utility enables you to easily use and configure PC Cards that conform to the PCMCIA specification. The CardAgent Utility allows you to:

- View the Client Driver List
- View the Event Log
- Run Diagnostics
- Edit Associations
- Edit the PC Card List

Viewing the Client Driver List

The Client Driver List shows all the PC Card drivers currently registered with Card Services and loaded on your computer. To view this list, do the following:

1 Click on **View** to pull down the View menu.

2 Select **Client Driver List...**

To view more information on a client driver, click on the desired client driver; then click on **More Info...** Refer to the table below which shows the required driver for the corresponding PC Card function:

PC Card Function	Required PC Card Driver
Memory, FLASH, SRAM	PCMMTD
LAN, FAX, Modem	PCMSCD
ATA	PCMATA

If you are trying to use a function for which the required driver has not registered with the Card Services, you need to install the client driver provided by the PC Card vendor that is included with the PC Card in order to add the necessary driver to your CONFIG.SYS file.

Viewing the Event Log

Clicking on the **Event Log** button in the CardAgent main window opens the Event Log Viewer window. The Event Log contains information about all events related to the PC Card slots in your computer including card insertions/extractions, card configuration success/failures, card event-action associations, and programs launched. The information in the Event Log is listed in chronological order, with each message identified by a three-letter acronym to indicate its origin as follows:

- AGT - CardAgent
- EPD - Event Processor Daemon
- STP - PCMSetup
- EPS - Install Program

You can customize the Event Log to specify the type of information displayed. Card Agent saves the Event Log as a text file, PCM.LOG, in the directory into which you installed CardAgent. You can use the Event Log (or review, print out PCM.LOG) to assist you in diagnosing problems that you may experience with your PC cards.

When you have finished reviewing the Event Log, click on **OK** to return to the CardAgent main window.

Performing PC Card Diagnostics

CardAgent provides you with a number of tools to diagnose the cause of any errors you may encounter. Some of these tools are for reference, and you should need to contact Technical Support personnel for assistance.

When you click on **Diagnostics** from the CardAgent main window, CardAgent displays a dialog box in which you can select the following options for generating reports to review or print:

- *Report of Log.* When you enable this option, CardAgent generates a summary of the Event Log, and saves that report as REPORT.TXT in the directory into which you installed CardAgent.
- *CIS Dump of Socket n.* CIS refers to Card Information Structures. There are 2 CIS Dump of Socket options that you can enable. When you enable this option, CardAgent generates a text file of the CIS of the PC card that is inserted in the corresponding socket or slot, and saves that file as CISDUMP.TXT in the directory into which you installed CardAgent.

Click on the radio button of the desired diagnostic option; then click on **OK** to accept and return to the CardAgent main window.

Configuring PC Cards

Attention:

If you are using a PC Card for the first time, you need to install the client driver provided by the PC Card vendor that is included with the PC Card.

When configuring cards, you have the option of resolving resource conflicts automatically or manually. If you choose the automatic option, CardAgent does all the work for you. If you select the manual option, CardAgent launches its user interface when you insert a card that it is unable to configure due to resource conflicts.

CardAgent provides you with the tools you need to use PC Cards without any difficulty. If you have used a card previously and you need to add or edit a configuration, click on the **Configurations** button in the CardAgent main window.

In most cases, CardAgent will automatically configure any PCMCIA-compliant card, and all you have to do is (1) install the client driver of the PC Card, and (2) insert the PC Card into the PC Card slot in your computer. When a card cannot be automatically configured, CardAgent enables you to allocate resources to make the card functional. If you insert a card and it does not immediately function properly, the cause may be either one of the following:

- CardAgent does not recognize the card
- CardAgent cannot automatically configure the card.

In either case, you will have to edit the card's configuration. The Edit Configuration window allows you to assign values for the following resources:

- Configuration Registers
- DMA
- I/O Window
- IRQ
- Memory Window
- Voltage

CardAgent Utility

In most cases, the default values displayed in the Edit Configuration window should suffice. However, some cards require specific values for these resources. Check the documentation that accompanies your card to determine the required values that you must enter.

After you have entered the necessary values (or have accepted the displayed defaults), click on **Validate**. If CardAgent validates the current configuration values, it displays a message indicating that the configuration was successful.

After the card has been configured, click on the **Configuration Loaded** checkbox.

Click on **Save** to write the configuration data to the PCM.INI file. When the data has been written to PCM.INI, CardAgent closes the Edit Configuration window and returns to the main window.

If CardAgent is unable to validate the configuration, or cannot successfully configure a card, the cause for the failure is usually a resource conflict. You will have to take extra steps to resolve resource conflicts.

Resolving PC Card Conflicts

If CardAgent cannot successfully configure a card due to resource conflicts, do the following:

- 1** Go to the MS-DOS prompt.
- 2** Move to the directory into which you installed CardAgent. (The default path is C:\PCM4\PROGRAM\.)
- 3** Type **PCMRMAN /MAP** at the prompt.

PCMRMAN.EXE, CardAgent's resource management utility, displays all resources, including DMA channels, I/O ranges, memory ranges, and IRQs, that are either Available, Unavailable, or In Use by another PC card.

- 4** When you have determined the availability of resources, return to the Edit Configuration window within CardAgent.

- 5** Enter the necessary values, validate the configuration values, and save the configuration as you would normally do when you are configuring cards.
- 6** If the card that you are trying to configure requires (per the card manufacturer's instructions) resources that are in use by another PCMCIA card or application, then you must remove that card from the slot, or close the application in question, and retry configuring the card.

Understanding Event-Triggered Associations

To setup or modify an association with a PC Card do the following:

- 1** Insert into a socket the card for which you want to create or modify an association.
- 2** From the CardAgent main window, click on the appropriate slot number that contains the card you just inserted, and then click on the **Associations** button.
- 3** If you want to modify an existing association, highlight that association from the resulting Association list and click on **Edit Info**.
- 4** If you want to create a new association, click on **New**.
- 5** For the associated Event, click on the down arrow to the right of the Event field and highlight the appropriate event in the subsequent pull down menu. These are the events that you can choose:
 - Card Insertion
 - Card Insertion Failure
 - Card Extraction
 - Power Management Suspend
 - Power Management Resume
 - Time Triggered

Note:

If you specify Time-Triggered as the event, the only available action is Launching a Program.

- 6** For the associated Action, click on the down arrow to the right of the Action field and highlight the appropriate action in the subsequent pull down menu. These are the actions that you can choose:
 - Launch A Program
 - Terminate A Program
 - Display A Message Box
 - Send A Windows Message
- 7** After you select the action and provide the required information for the subsequent fields that correspond the selected action, make sure the **Association Enabled** is checked, and then click on **Save**. Or, if you decide not to complete this association, click on **Cancel**.

When you click on Save or Cancel, CardAgent returns to the Event Triggered Associations list window. To complete the association, click on **OK**, after which CardAgent writes the new association to the PCM.INI file and returns to the CardAgent main window.

Appendix C. BIOS Utility

Your computer has a BIOS Utility that allows you to configure the computer and its hardware settings. This appendix tells how to use the BIOS Utility and describes each parameter item in the setup screens.

Note

The computer is also bundled with a Windows 95-based computer management utility similar in function with the BIOS Utility called the Notebook Manager. See page 3-3 for details.

When to Use the BIOS Utility

When to Use the BIOS Utility

The computer is already correctly configured for you. If you make any changes to the computer or you receive an Equipment Configuration Error message (error code 246) after you turn on the computer, you need to run BIOS Utility.

The BIOS Utility has the following functions:

- Change the system date or time
- Set the power-saving modes and timers
- Set, change, or remove a system password
- Change the system boot drive or display device
- Add or remove serial and parallel devices
- Set the video display features
- Change CardBus support mode

Entering the BIOS Utility

Note:

If the Setup password is set, you need to enter the Setup password to gain access to the BIOS Utility.

Press **F2** while the ThinkPad logo is being displayed after power-on to enter the BIOS Utility. When the power-on password is set, press **F2** within three seconds after you input your password and hit the **Enter** key to enter the BIOS Utility. The main screen displays.

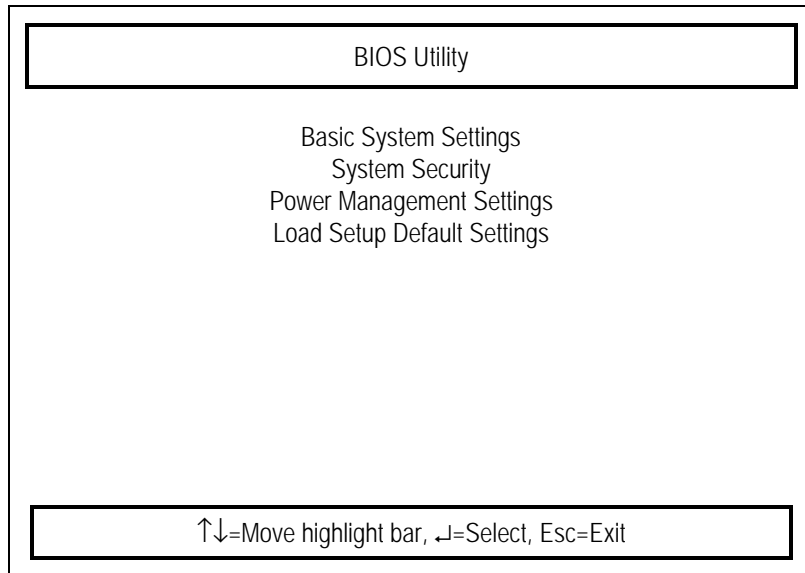

There are four main menu items:

- Basic System Settings
- System Security
- Power Management Settings
- Load Setup Default Settings

Entering the BIOS Utility

Using the BIOS Utility

- From the main menu screen, press \uparrow or \downarrow to move from one menu item to another and press **Enter** to enter the selected menu.
- Parameters displayed in low brightness (grayed-out) are not user-configurable. The computer detects and sets the values for these parameters.
- Press \uparrow or \downarrow to move from one parameter to another. Press \leftarrow or \rightarrow to change parameter settings. You have to change some settings when you add a component to the computer.
- Most of the parameters are self-explanatory.
- To exit a main menu item, press **Esc**.

Exiting the BIOS Utility

When you press **Esc** to exit the BIOS Utility from the main menu screen, the following prompt appears:

Do you want to save CMOS data?

[Yes] [No]

Select **Yes** to save the changes you made to the configuration values or **No** to abandon the changes and retain the current values.

Basic System Settings

Date

The computer displays the current date in Mmm DD, YYYY format. For example, Jan 01, 1997.

Time

The computer displays the current time in HH:MM:SS 24-hour format. For example, 18:25:00.

Diskette A

Diskette B

The default setting for Diskette A is 1.44 MB 3.5-inch and this setting applies to both an internal and external diskette drive configuration.

Hard Disk Drive

The default setting for Hard Disk is Auto. With this setting, the BIOS automatically detects your drive parameters. You can also opt to key in your drive parameters by setting this parameter to User. To determine your drive parameters, look at the data on the label pasted on your hard disk drive (or supplied in vendor documentation) and type in the parameters. Be sure to set the correct drive parameters; otherwise an error message appears when you boot up the computer. Setting this parameter to Auto is recommended.

Memory Test

Your computer can test main memory for errors when you turn it on. The default setting, Disabled, allows the computer to bypass the memory test and speed up the self-test procedure.

Basic System Settings

Boot Display

Note:

If the computer resolution is set at 640x480, the image on the computer LCD and external monitor will not be full-screen. For full-screen image, set-up the computer LCD at 800x600 resolution.

If you connect an external monitor, you can switch display between the LCD and the external display. This parameter determines which display device the computer uses on boot-up. The following table describes the settings.

Setting	Description
Auto (default)	If an external display is present, the computer uses the external display; otherwise, the LCD is the display device.
Both	The computer uses the external display and LCD simultaneously.

System Security

In the Disk Drive Control menu, you can set the following parameters.

Diskette Drive

This parameter allows you to enable or disable the read/write functions of the diskette drive. The following table summarizes the available options.

Setting	Description
Normal (default)	Diskette drive functions normally.
Write Protect All Sectors	Disables the diskette drive write function. This option is for operating systems that access the diskette drive 100 percent via BIOS only.
Write Protect Boot Sector	Disables the write function on a diskette's boot sector. This option is for operating systems that access the diskette drive 100 percent via BIOS only.
Disabled	Disables the diskette drive.

Hard Disk Drive

This parameter allows you to enable or disable the read/write functions of the hard disk drive. The following table summarizes the available options.

Setting	Description
Normal (default)	Hard disk drive functions normally.
Write Protect All Sectors	Disables the hard disk drive write function. This option is for operating systems that access the hard disk 100 percent via BIOS only.
Write Protect Boot Sector	Disables the write function on the hard disk's boot sector. This option is for operating systems that access the hard disk 100 percent via BIOS only.

System Security

Disabled	Disables the hard disk drive.
----------	-------------------------------

System Boot Drive

This parameter determines which drive the computer boots from when you turn it on. The following table lists the possible settings.

Setting	Description
Drive A Then C (default)	Computer boots from diskette drive A. If there is no system disk in drive A, the computer boots from hard disk C. If the hard disk is a non-system disk, an error message appears.
Drive A	Computer boots from diskette drive A. If no diskette is present or if the diskette in diskette drive A is a non-system disk, an error message appears.
Drive C	Computer boots from hard disk C. If hard disk C is not a system disk, an error message appears.
Drive C Then A	Computer boots from hard disk C. If hard disk C is not a system disk, the computer boots from diskette drive A. If no diskette is present or if the diskette in diskette drive A is a non-system disk, an error message appears.

CD-ROM Bootable

When enabled, the computer checks the CD-ROM drive first and boots from there, if possible, before checking the System Boot Drive control setting. The default setting is Disabled.

There are two image types/formats for CD-ROMs -- diskette drive and hard disk:

Image Type	Upon Boot-up...
Diskette Drive	CD-ROM drive becomes drive A and the diskette drive becomes drive B. The hard disk drive remains drive C.
Hard Disk	CD-ROM drive becomes drive C and the hard disk drive becomes drive D. The diskette drive remains drive A.

The On Board Communication Ports menu allows you to change the following parameters.

Serial Port 1 Base Address

Note:

The serial port base address is expressed in hexadecimal format.

The serial port can accommodate a modem, serial mouse, serial printer, or other serial devices. The default setting for the serial port base address is 3F8h(IRQ 4).

Other options include:

- 2F8h(IRQ 3)
- 3E8h(IRQ 4)
- 2E8h(IRQ 3)
- Disabled

Caution

Make sure the serial port base address does not conflict with the address used by a PCMCIA card, if one is installed.

Parallel Port Base Address

Note:

The parallel port base address is expressed in hexadecimal format.

The parallel port can accommodate a parallel printer or other parallel devices. The default setting for the parallel port base address is 3BCh(IRQ 7). The other options for this parameter are:

- 278h(IRQ 5)
- 378h(IRQ 7)
- Disabled

Parallel Port Operation Mode

The parallel port supports four operation modes:

- Standard and Unidirectional
- Standard and Bidirectional
- Enhanced Parallel Port(EPP)
- Extended Capabilities Port(ECP)

System Security

EPP or Enhanced Parallel Port is a parallel port interface that greatly improves performance for bi-directional block-mode data transfers. EPP provides greater throughput by supporting faster transfer times and a mechanism that allows the host to address peripheral device registers directly. ECP or Extended Capabilities Port supports a 16-byte FIFO (first in, first out) which can be accessed by PIO cycles. ECP boosts I/O bandwidth to meet the demands of high-performance peripherals.

The default setting is Standard and Bidirectional.

If you set EPP as the parallel port operation mode, 3BCh is not available as the parallel port base address; otherwise, I/O conflicts may occur.

Setup Password Power On Password

Two passwords are implemented in this computer. The Setup Password prevents unauthorized access to the BIOS Utility. The Power On Password prevents unauthorized access to the computer during boot-up and resume from hibernation.

Setting a Password

- 1** To set a password, select the desired password (Setup or Power On) to set or edit, and press ← or →. The password prompt appears as follows:



You can use any combination of up to 7 characters. Use a combination of any letters or numbers (A to Z, 0 to 9) in uppercase (A) or lowercase (a). Uppercase and lowercase letters (for example, A and a) are treated the same.

The password does not appear on the screen when you type them. You can erase a character by using the backspace key. To cancel the operation, press **Esc**.

2 After typing your password, press **Enter**.

Another prompt appears asking you to retype your password to verify your first entry.

3 After typing your password again, press **Enter**.

After setting a password, the computer sets this parameter to Enabled.

Removing a Password

To remove a password, select the desired password (Setup and Power On) to remove and press ← or → to set it to None.

How the Password Works

- If the Power On Password is set, the next time you boot the computer or resume from hibernation mode, the password prompt appears. Key in the Power On password.
- If the Setup Password is set, the password prompt appears when you access the BIOS Utility (pressing F2 while the ThinkPad logo is being displayed). Key in the Setup password.

In either case, you have three chances to type in the correct password. If the password you entered is incorrect, an “X” appears. If you do not successfully enter the correct password, the following message appears after three tries:

Incorrect password specified. System disabled.

The computer freezes up and disables all devices. You must turn off the computer and turn it on again to retry.

Do Not Forget Your Password!

Note the password and keep it in a safe place.

If you forget your password, **you cannot reset it**. You have to take the computer to an IBM authorized reseller or IBM marketing representative to have the password canceled. Proof of purchase is required, and an additional charge might be required for the

service.

CardBus Support

When you use CardBus PC Cards or ZV port PC Cards, this parameter needs to be set to **Enabled**. To use PCMCIA R2.0 or R2.1 PC Cards with 16-bit Windows 3.11/DOS applications, this parameter must be set to **Disabled**. The default setting is **Disabled**.

Important!

Microsoft Windows 95 does not guarantee that all DOS/Windows 3.11 applications will run under Windows 95. Before you attempt to run a DOS/Windows 3.11 application under Windows 95, you need to contact technical support personnel for the application to confirm if it works under Windows 95.

Power Management Settings

Besides accessing this screen from POST (while the ThinkPad logo is displayed) using F2, you can also press **Fn+F6** during runtime to access this section of the BIOS Utility.

Power Management Mode

Note:

You cannot disable this parameter in the BIOS Utility if APM is installed under DOS, Windows or Windows 95. To disable APM, type Power Off under DOS, or disable the Power icon in the Windows Control Panel.

To disable power management timers, set the desired timer to Off.

When enabled, all the power management timers take effect unless specifically disabled by the user. Select Disabled to turn off all the timers. The default setting is Enabled.

Display Standby Timer

The computer shuts off the LCD backlight and turns off the CRT video as well, if there is no activity from the keyboard, TrackPoint III or external PS/2 mouse within the period specified by this timer. To turn the display back on, press a key, move TrackPoint III or move the mouse.

The valid values for this timer range from 1 to 60 minutes with default set at 5.

Hard Disk Standby Timer

The hard disk drive enters standby mode if there are no disk read/write operations within the period specified by this timer. The hard disk returns to normal mode once the computer accesses it.

The valid values for this timer range from 1 to 20 minutes with default set at 10.

Power Management Settings

Note:

Auto-insert notification needs to be disabled for the computer to enter standby or hibernation mode. To check, click on Start, Settings, then Control Panel. Double-click on System and click on the Device Manager tab. Double-click on CDROM, then double-click on the CD-ROM device. Click on the Settings tab and make sure the auto insert notification item is not checked. Click on **OK** to accept.

System Standby Timer

This parameter enables you to set a timeout period for the computer to enter standby mode. The valid values for this timer range from 1 to 60 minutes with default set at Off.

System Hibernation Timer

This parameter enables you to set a timeout period for the computer to enter hibernation mode. The valid values for this timer range from 1 to 90 minutes with default set at Off.

Note:

When the computer is in hibernation mode, it cannot resume when this parameter is enabled.

System Resume Timer Mode

When enabled, the computer resumes from standby mode at the specified Resume Date and Resume Time parameter settings.

System Resume Date

System Resume Time

The System Resume Date and System Resume Time parameters let you set the date and time for the resume operation. The date field format is MM/DD/YYYY. The time field takes the same format as the System Time parameter in the Basic System Settings screen.

Setting a resume date and time that is not valid automatically disables these fields. A successful resume occurring from a date and time match automatically disables these fields.

Modem Ring Resume On Indicator

Note:

When the computer is in hibernation mode, it cannot resume from a modem ring.

When enabled, the computer wakes up from standby mode and returns to normal mode when a PCMCIA modem detects a ringing tone. The default setting is Enabled.

Battery-low Warning Beep

This parameter allows you to enable or disable the warning beep generated by the computer when a battery-low condition occurs. The default setting is Enabled.

Sleep Upon Battery-low

Note:

Make sure Sleep Manager is installed and the hibernation file is present and valid; otherwise, the computer enters standby mode upon battery-low. For more information on *Creating the Hibernation File*, see page 4-15.

This parameter enables the computer to enter standby or hibernation mode when a battery-low condition takes place. The default setting is Enabled.

Load Setup Default Settings

Load Setup Default Settings

Selecting this option allows you to load all the default settings. The default settings are intended to provide high performance. Even if you change these settings, you can load the default settings again by selecting this option.

When you select this option, the following prompt appears:

Do you want to load default settings? [Yes] [No]
--

Select **Yes** to load the default settings or **No** to abort the operation.

Appendix D. Features and Specifications

This appendix describes the features and specifications for the IBM ThinkPad 310E or 310ED computer.

Microprocessor

- Intel Pentium processor with MMX technology
- 256KB external cache memory

Memory

- Built-in: 16MB RAM
- Optional: 16MB, 32MB EDO DIMM (for ThinkPad 310)

Storage devices

- 2.5-inch hard disk drive (upgradeable)
- **310E** 3.5-inch diskette drive
- **310ED** 3.5-inch external diskette drive (for CD-ROM models)
- **310ED** 5.25-inch CD-ROM (for CD-ROM models)

Display

The SVGA color LCD display uses either TFT or DSTN technology (depending on the model) and supports:

- DSTN color LCD
 - Up to 256 colors
 - Up to 800-by-600 resolution on the LCD
 - Up to 1024-by-768 resolution on the external monitor
 - Brightness control and contrast control (using hot keys)
 - 1 MB built-in VRAM
- TFT color LCD
 - Up to 65,536 colors
 - Up to 800-by-600 resolution on the LCD
 - Up to 1024-by-768 resolution on the external monitor
 - Brightness control (using hot key)
 - 1 MB built-in VRAM

Features and Specifications

Keyboard

- 85-key, 86-key, or 89-key
- TrackPoint III
- Fn key functions
- Embedded numeric keypad

Audio

- Compatible with Sound Blaster Pro

External interface

- DC-in jack for AC Adapter
- Serial connector (EIA-RS232D)
- Parallel connector (Centronics)
- External input-device connector
- External monitor connector
- External diskette drive connector
- Audio line-in jack
- Audio line-out/headphone jack
- Microphone jack
- Two PCMCIA slots (accept two Type I or Type II PC Cards, or one Type III PC Card)

Specifications

Size

- Width: 298 mm (11.73 in.)
- Depth: 227 mm (8.94 in.)
- Height: 50 mm (1.97 in.)

Weight

Total system weight varies, depending on the LCD and hard disk drive installed.

- **310E** For models with an internal diskette drive:
 - 3.0 kg (6.6 lb)
- **310ED** For models with a built-in CD-ROM:
 - 3.2 kg (7.1 lb)

Environment

- Temperature
 - Operating: 10°C to 35°C (50°F to 95°F)
 - Nonoperating: -20°C to 60°C (-4°F to 140°F)
- Relative Humidity:
 - Operating 20% to 80% (noncondensing)
- Altitude: -61 m (-200 ft) to 3048 m (10,000 ft)

Heat output

- Approximately 153.5 British thermal units (BTUs) per hour (45.0 watts)

Electrical (AC Adapter)

Sine-wave input, at 50 to 60 Hz, is required

- 100-240 V ac

Diskette Standards

To get the best performance from your diskette drives, use high-quality diskettes (such as IBM diskettes) that meet or exceed the following standards:

1 MB, 3.5-inch, unformatted diskette:

- ANSI (American National Standard Institute) X3. 137
- ISO (International Standards Organization) 8860
- ECMA (European Computer Manufacturers' Association) 100

2 MB, 3.5-inch, unformatted diskette:

- ANSI X3. 171
- ISO 9529
- ECMA 125

IBM Power Cords

IBM power cords for a specific country are usually available only in that country.

Note

The grounded adapter (for 3-pin power cords) is required for full MPRII compliance.

IBM Power Cord Part Number	Used in These Countries
3 -pin Power Cords	
76H3514	Argentina, Australia, Papua New Guinea, New Zealand, Paraguay, Uruguay
76H3516	Bahamas, Barbados, Bermuda, Bolivia, Canada, Cayman Islands, Colombia, Costa Rica, Dominican Republic, Ecuador, El Salvador, Guatemala, Guyana, Haiti, Honduras, Jamaica, Korea (South), Mexico, Netherlands, Antilles, Nicaragua, Panama, Peru, Philippines, Saudi Arabia, Suriname, Taiwan, Trinidad (West Indies), United States of America, Venezuela
76H3518	Austria, Belgium, Bulgaria, Czech Republic, Egypt, Finland, France, Germany, Greece, Hungary, Iceland, Indonesia, Netherlands, Norway, Poland, Portugal, Romania, Slovakia, Spain, Sweden, Turkey, former Yugoslavia
76H3520	Denmark
76H3522	Bangladesh, Pakistan, South Africa, Sri Lanka
76H4866	Thailand
76H3524	Abu Dhabi, Albania, Antigua, Bahrain, Brunei, Dubai, Fiji, Hong Kong, India, Ireland, Kenya, Kuwait, Macao, Malaysia, Nigeria, Oman, People's Republic of China, Qatar, Singapore, United Kingdom
76H3528	Switzerland
76H3530	Chile, Italy
76H3532	Israel
2 -pin Power Cords	
13H5273	Japan (2-pin)

IBM Power Cords

Attention:

If a 3-pin power cord came with your computer, you must follow the following safety notice.



Electrical current from power, telephone, and communication cable is hazardous. To avoid shock, hazard, connect and disconnect cables as shown below when installing, moving or opening the covers of this product or attached devices. The 3-pin power cord must be used with a properly grounded outlet.

Note: In the U.K., by law:

- The telephone line cable must be connected after the power cord.
- The power cord must be disconnected after the telephone line cable.

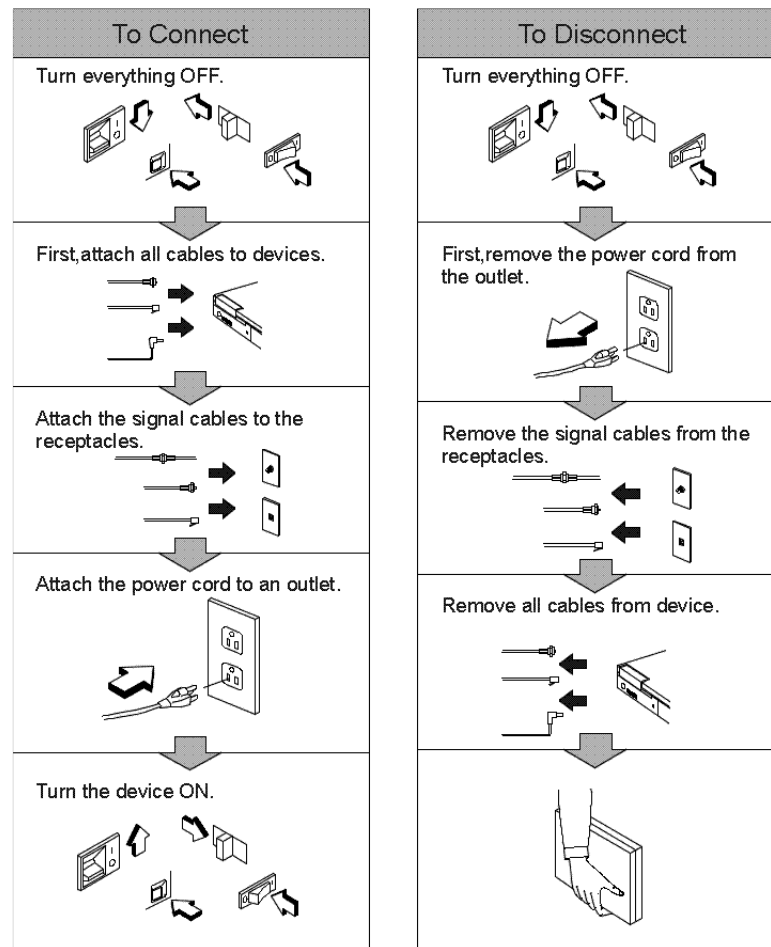

Appendix E. Product Warranties and Notices

International Business Machines Corporation

Armonk, New York 10504

Statement of Limited Warranty

The warranties provided by IBM in this Statement of Limited Warranty apply only to Machines you originally purchase for your use, and not for resale, from IBM or an IBM authorized reseller. The term "Machine" means an IBM machine, its features conversions, upgrades, elements, or accessories, or any combination of them. Machines are subject to these terms only if purchased in the United States or Puerto Rico, or Canada, and located in the country of purchase. If you have any questions, contact IBM or your reseller.

Machine: IBM ThinkPad 310E or 310ED and the Battery Pack

Warranty Period*: One Year

**Elements and accessories are warranted for three months. Contact your place of purchase for warranty service information.*

Production Status

Each Machine is manufactured from new parts, or new and serviceable used parts (which perform like new parts). In some cases, the Machine may not be new and may have been previously installed. Regardless of the Machine's production status, IBM's warranty terms apply.

The IBM Warranty

IBM warrants that each Machine 1) is free from defects in materials and workmanship and 2) conforms to IBM's Official Published Specifications. IBM calculates the expiration of the warranty period from the Machine's Date of installation. The date on your receipt is the Date of Installation, unless IBM or your reseller informs you otherwise.

During the warranty period, IBM or your reseller will provide warranty service under the type of service designated for the Machine and will manage and install engineering changes that apply to the Machine. IBM or your reseller will specify the type of service.

For a feature, conversion, or upgrade, IBM or your reseller may require that the Machine on which it is installed be 1) the designated, serial-numbered Machine and 2) at an engineering-change level compatible with the feature, conversion, or upgrade. Some of these transactions (called "Net-Priced" transactions) may include additional parts and associated replacement parts that are provided on an exchange basis. All removed parts become the property of IBM and must be returned to IBM.

Replacement parts assume the remaining warranty of the parts they replace.

If a Machine does not function as warranted during the warranty period, IBM or your reseller will repair or replace it (with a Machine that is at least functionally equivalent) without charge. If IBM or your reseller is unable to do so, you may return it to your place of purchase and your money will be refunded.

If you transfer a Machine to another user, warranty service is available to that user for the remainder of the warranty period. You should give your proof of purchase and this Statement to that user.

Product Warranties

Warranty Service

To obtain warranty service for the Machine, you should contact your reseller or call IBM. In the United States, call IBM at 1-800-772-2227. In Canada, call IBM at 1-800-565-3344. You may be required to present proof of purchase.

Depending on the Machine, the service may be 1) a "Repair" service at your location (called "On-site") or at one of IBM's or a reseller's service locations (called "Carry-in") or 2) an "Exchange" service, either On-site or Carry-in.

When a type of service involves the exchange of a Machine or part, the item IBM or your reseller replaces becomes its property and the replacement becomes yours. The replacement may not be new, but will be in good working order and at least functionally equivalent to the item replaced.

It is your responsibility to:

1. obtain authorization from the owner (for example, your lessor) to have IBM or your reseller service a Machine that you do not own
2. where applicable, before service is provided —
 - a) follow the problem determination, problem analysis, and service request procedures that IBM or your reseller provide,
 - b) secure all programs, data, and funds contained in a Machine,
 - c) inform IBM or your reseller of changes in a Machine's location, and
 - d) for a Machine with exchange service, remove all features, parts, options, alterations, and attachments not under warranty service. Also, the Machine must be free of any legal obligations or restrictions that prevent its exchange; and
3. be responsible for loss of, or damage to, a Machine in transit when you are responsible for the transportation charges.

Extent of Warranty

IBM does not warrant uninterrupted or error-free operation of a Machine.

Unless IBM specifies otherwise, IBM provides non-IBM machines on an "AS IS" basis. However, non-IBM manufacturers may provide their own warranties to you.

Misuse, accident, modification, unsuitable physical or operating environment, improper maintenance by you, removal of product labels or parts identification labels, or failure caused by a product for which IBM is not responsible may void the warranties.

THESE WARRANTIES REPLACE ALL OTHER WARRANTIES, EXPRESS OR IMPLIED, INCLUDING, BUT NOT LIMITED TO, THE IMPLIED WARRANTIES OF MERCHANTABILITY AND FITNESS FOR A PARTICULAR PURPOSE. HOWEVER, SOME LAWS DO NOT ALLOW THE EXCLUSION OF IMPLIED WARRANTIES. IF THESE LAWS APPLY, THEN ALL EXPRESS AND IMPLIED WARRANTIES ARE LIMITED IN DURATION TO THE WARRANTY PERIOD. NO WARRANTIES APPLY AFTER THAT PERIOD.

In Canada, warranties include both warranties and conditions.

Some jurisdictions do not allow limitations on how long an implied warranty lasts, so the above limitation may not apply to you.

Limitation of Liability

Circumstances may arise where, because of a default on IBM's part (including fundamental breach) or other liability (including negligence and misrepresentation), you are entitled to recover damages from IBM. In each such instance, regardless of the basis on which you are entitled to claim damages, IBM is liable only for:

1. bodily injury (including death), and damage to real property and tangible personal property; and
2. the amount of any other actual loss or damage, up to the greater of \$100,000 or the charge for the Machine that is the subject of the claim.

Under no circumstances is IBM liable for any of the following:

1. third-party claims against you for losses or damages (other than those under the first item listed above);
2. loss of, or damage to, your records or data; or
3. economic consequential damages (including lost profits or savings) or incidental damages, even if IBM is informed of their possibility.

Some jurisdictions do not allow the exclusion or limitation of incidental or consequential damages, so the above limitation or exclusion may not apply to you.

This warranty gives you specific legal rights and you may also have other rights which vary from jurisdiction to jurisdiction.

Notices

Notices

References in this publication to IBM products, programs, or services do not imply that IBM intends to make these available in all countries in which IBM operates. Any reference to an IBM product, program, or service is not intended to state or imply that only IBM's product, program, or service may be used. Any functionally equivalent product, program, or service that does not infringe any of IBM's intellectual property rights may be used instead of the IBM product, program, or service. Evaluation and verification of operation in conjunction with other products, except those expressly designated by IBM, are the user's responsibility.

IBM may have patents or pending patent applications covering subject matter in this document. The furnishing of this document does not give you any license to these patents. You can send license inquiries, in writing, to:

IBM Director of Licensing
IBM Corporation
500 Columbus Avenue
Thornwood, NY 10594
U.S.A.

Trademarks

The following terms are trademarks of the IBM Corporation in the United States or other countries or both:

AT	IBM	ThinkPad
HelpWare	PS/2	TrackPoint III

Windows is a trademark of Microsoft Corporation.

Other company, product, and service names, which may be denoted by a double asterisk (**), may be trademarks or service marks of others.

Electronic Emission Notices

Federal Communications Commission (FCC) Statement

Note: This equipment has been tested and found to comply with the limits for a Class B digital device, pursuant to Part 15 of the FCC Rules. These limits are designed to provide reasonable protection against harmful interference in a residential installation. This equipment generates, uses, and can radiate radio frequency energy and, if not installed and used in accordance with the instructions, may cause harmful interference to radio communications. However, there is no guarantee that interference will not occur in a particular installation. If this equipment does cause harmful interference to radio or television reception, which can be determined by turning the equipment off and on, the user is encouraged to try to correct the interference by one or more of the following measures:

- Reorient or relocate the receiving antenna.
- Increase the separation between the equipment and receiver.
- Connect the equipment into an outlet on a circuit different from that to which the receiver is connected.
- Consult an IBM authorized dealer or service representative for help

Properly shielded and grounded cables and connectors must be used in order to meet FCC emission limits. Proper cables and connectors are available from IBM authorized dealers. IBM is not responsible for any radio or television interference caused by using other than recommended cables and connectors or by unauthorized changes or modifications to this equipment.

Unauthorized changes or modifications could void the user's authority to operate the equipment. This device complies with Part 15 of the FCC Rules. Operation is subject to the following two conditions: (1) this device may not cause harmful interference, and (2) this device must accept any interference received, including interference that may cause undesired operation.

Electronic Emission Notices

Canadian Department of Communications Compliance Statement

This equipment does not exceed Class B limits per radio noise emissions for digital apparatus, set out in the Radio Interference Regulation of the Canadian Department of Communications.

Avis de conformité aux normes du ministère des Communications du Canada

Cet équipement ne dépasse pas les limites de Classe B d'émission de bruits radioélectriques pour les appareils numériques, telles que prescrites par le Règlement sur le brouillage radioélectrique établi par le ministère des Communications du Canada.

European Community Directive Conformance Statement

This product is in conformity with the protection requirements of EC Council Directive 89/336/EEC on the approximation of the laws of the Member States relating to electromagnetic compatibility.

IBM cannot accept responsibility for any failure to satisfy the protection requirements resulting from a non-recommended modification of the product, including the fitting of non-IBM option cards.

A declaration of Conformity with the requirements of the Directive has been signed by IBM Japan, Ltd. 1623-14, Shimotsuruma, Yamato-shi, Kanagawa-ken, 242, Japan.

This product satisfies the Class B limits of EN 55022.

Energy Star Logo Statement

As an Energy Star Partner, IBM has determined that this product meets Energy Star guidelines for energy efficiency.

This glossary includes terms and definitions from the IBM Dictionary of Computing (New York; McGraw-Hill, 1994).

ac (AC). Alternating current.

ac power. Power that is supplied to the computer through an electrical outlet.

Advanced Power Management (APM). A facility consisting of one or more layers of software that support power management in computers with power manageable hardware. The APM software interface allows applications, operating systems, device drivers, and the APM BIOS to work together to reduce power consumption, without reducing system performance.

ANSI. American National Standards Institute.

APM. Advanced Power Management.

application program. A program that performs specific tasks on your computer, such as word processing or creating spreadsheets.

ASCII. American National Standard Code for Information Interchange.

ATA PC Card. A PC Card with an AT attachment hard disk drive interface such as a storage device PC Card.

AUTOEXEC.BAT. A file that contains a startup procedure of DOS. Each time you start your system, DOS performs the commands that are stored in this file.

backup copy. A copy, usually of a file or group of files, that is kept in case the original file or files are unintentionally changed or destroyed.

batch. A process method in which a program or programs records with little or no operator action.

BIOS (Basic Input/Output System). Microcode that contains such basic hardware operations as interactions with diskette drives, hard disk drives, and the keyboard.

bitmap graphics. (1) A form of graphics in which all points on the display are directly addressable, (2) In multimedia applications, a form of graphics in an area of computer memory or storage that can be displayed as an image.

boot. To prepare a computer system for operation by loading an operating system.

bus. A facility for transferring data between several devices located between two end points, only one device being able to transmit at a given moment.

cache memory. A special memory, smaller and faster than main memory, that is used to hold a copy of instructions and data in main memory that is likely to be needed next by the processor, and that have been obtained automatically from main memory.

CD. Compact disc.

CD-I. Compact disc-interactive.

CD-ROM. Compact disc read-only memory.

combination keys. Keys that have specific functions when you hold them down at the same time.

CONFIG.SYS. A file that contains a group of commands to load installable device drivers and reserve space in system memory for information processing. This file is referred to by DOS during system startup.

configuration. (1) The manner in which hardware and software of an information processing system are organized and interconnected, (2) The physical and logical arrangement of devices and programs that make up a data processing system, (3) The devices and programs that make up a system, subsystem, or network.

CRT. Cathode ray tube display.

device driver. A file that contains the code needed to attach and use a device. The operating system loads device drivers for screens, keyboards, printers, diskette drives, hard disk drives, and auxiliary devices. The user can replace these or add other devices by coding and loading a device driver.

DIMM. Dual inline memory module.

directory. A type of file containing the names and controlling information for other files or other directories.

DMA. Direct memory access. The transfer of data between memory and input/output units without processor intervention.

double-click. To press and release a mouse button twice within a time frame defined by the user, without moving the pointer off the choice.

Glossary

DRAM. Dynamic random access memory.

DSTN. Dual-scan, super-twisted nematic.

EDO. Enhanced Data Output or Extended Data Out. A type of DRAM that offers faster access to data in memory.

EGA. Enhanced graphics adapter.

EIA. Electronics Industries Association.

EIA-232D. An EIA interface standard that defines the physical, electronic, and functional characteristics of an interface line that connects a communication device and associated workstation. It uses a 25-pin connector and an unbalanced line voltage.

EMS. Expanded memory specification.

fax. Facsimile machine or transmitted document.

FDD. Floppy disk drive.

fixed disk. In personal computing, *fixed disk* is synonymous with *hard disk*.

flash memory. A rewritable storage that is used to contain BIOS instructions and POST routines.

folder. A file used to store and organize documents.

fuel gauge. An indicator on the screen that constantly shows the current power status of the battery pack.

HDD. Hard disk drive.

HHR. Half-horizontal resolution.

hibernation mode. One of the power-saving methods that stores data and applications running in the computer's memory on the hard disk. During hibernation, the computer is automatically turned off to save power. When power is turned on again, the computer immediately restores the same data and applications as when hibernation mode started, without restarting the operating system.

high-performance mode. A method of increasing the access time of video memories for DSTN LCDs, to produce high-quality video on an external monitor (CRT).

high-resolution mode. Video resolutions that are greater than 640 x 480 pels.

icon. A graphic symbol, displayed on a screen, that a user can point to with a pointing device such as a mouse to select a particular function or software application.

IRQ. Interrupt request.

ISA. Industry standard architecture.

ISO. International Organization for Standardization.

JEIDA. Japan Electronics Industry Development Association.

kilobyte (KB). 1024 (2¹⁰) bytes.

LAN. Local area network.

LCD. Liquid crystal display.

LPT1 or LPT2. The name you can assign a parallel port to specify its address. See also *parallel port*.

mAh. Milliampere hours.

megabyte (MB). 1024 kilobytes. About 1 million bytes.

memory. Often referred to as random-access memory (RAM), measured in kilobytes (KB) or megabytes (MB) of information.

MHz. Megahertz.

microcode. One or more microinstructions used in a product as an alternative to hard-wired circuitry to implement functions of a processor or other system component.

MIDI. Musical Instrument Digital Interface.

modem. A device that connects your computer to a telephone line, allowing it to communicate with another computer at another location.

parallel port. A port used to attach such devices as dot-matrix printers and input/output units; it transmits data 1 byte at a time.

parity check. A redundancy check by which a recalculated parity bit is compared with the pre-given parity bit.

password. A series of letters or numbers that you designated to restrict access to your computer.

PC Card. A card that is based on the PCMCIA standard.

pel. Picture element.

picture element. In computer graphics, the smallest element of a display surface that can be independently assigned color and intensity.

pixel. Picture element.

pointing device. An instrument, such as a mouse, TrackPoint III, or joystick, that is used to move a pointer on the screen.

pop-up menu. On the display screen, a menu that emerges in an upward direction from a particular point or line on a display screen.

POST. Power-on self-test.

prompt. A visual or audible message sent by a program to request the user's response.

pull-down menu. On the display screen, a menu that emerges in a downward direction from a particular point or line at or near the top of the screen.

reboot. To restart all operations of the computer as if the power were just turned on.

resume. To begin computer operations again from standby mode.

serial port. A port used to attach such devices as display devices, letter-quality printers, modems, plotters, and such pointing devices as light pens and mice; it transmits data 1 bit at a time.

standby mode. A kind of suspend mode where only a part of the system components use power.

STN. Super-twisted nematic.

SVGA. Super video graphics adapter, a video mode that produces up to 1024-by-768 resolution.

TFT. Thin-film transistor.

TSRs. Terminate-and-stay-resident programs. Memory-resident programs that are loaded into memory and stay there so you can conveniently access them whenever you need to.

vertical expansion. A video display technique in character-display mode to fit video images on the whole LCD screen by adjusting the number of character dots vertically.

VESA. Video Electronics Standards Association.

VGA. Video graphics adapter, a video mode that produces up to 640-by-480 resolution.

XMS. Extended memory specification.

A

- AC Adapter
 - input rating, 2-8
 - power source, 2-8
 - using, 2-8
- Advanced Power Management (APM), 4-9
 - Windows, installing, 4-10
- America Online service, 8-16
- assistance, 8-10
- audio features, 3-20

B

- backup
 - creating installation diskettes, 7-5
- battery pack
 - charging, 4-2
 - maintaining, 4-4
 - maximizing battery-powered operation, 4-9
 - monitoring battery power using fuel-gauge, 4-8
 - monitoring battery power using status indicator, 4-7
 - preserving battery-pack life, 4-9
 - replacing, 4-5
- BIOS Utility, C-1
 - basic system settings, C-5
 - load setup default settings, C-16
 - power management settings, C-13
 - system security, C-7
 - using, C-4
- brightness and contrast
 - Fn key function, 2-13
- bulletin boards, 8-15

C

- carrying the computer, 2-18
- card services, 3-19
- CD-ROM drive
 - handling CDs, 3-23
 - using, 3-22
- certificate of authenticity for Windows 95, 1-5
- cleaning the computer, 2-17
- cleaning the TrackPoint cap, 2-12
- CompuServe, 8-16
- corrective service diskettes (CSDs), 8-19

D

- damage to the computer, preventing, 2-16
- device drivers, audio
 - for DOS, installing, 7-8
 - for Windows 3.11, installing, 7-13
 - for Windows 95, installing, 7-17
- device drivers, audio software
 - for Windows 95, installing, 7-17
- device drivers, CD-ROM
 - for DOS and Windows 3.11, installing, 7-10
 - for DOS, installing, 7-6
- device drivers, display
 - for Windows 3.11, installing, 7-11
 - for Windows 95, installing, 7-15
- device drivers, Notebook Manager
 - for Windows 95, installing, 7-18
- device drivers, PC Card
 - for DOS and Windows 3.11, installing, 7-12
- device drivers, PC Card update
 - for Windows 95, installing, 7-16
- device drivers, SafeOFF
 - for Windows 95, installing, 7-18
- device drivers, Sleep Manager
 - for DOS, installing, 7-7
 - for Windows 95, installing, 7-18
- device drivers, TDial
 - for Windows 95, installing, 7-19
- DIMM adapter, 6-8
- DIMM installation, 6-8
- diskette standards, D-4
- diskette drive
 - installing an external, 3-21
- display
 - adjusting brightness, 4-11
 - switching, using Fn key, 2-13
 - output type, 3-13
 - using, 3-13
- display standby mode, 4-14
- DOS Version 7.0, installing, 7-6
- DMA channel, system resource, A-2

Index

E

- electronic support, 8-15
- ergonomics information, ix
- error codes
 - POST, 8-6
 - runtime, 8-9
- external diskette drive, 1-5
- external keyboard
 - attaching, 6-12
- external monitor
 - attaching, 3-16
- external mouse
 - attaching, 6-11
- external numeric keypad
 - attaching, 6-11

F

- FAQ, 8-2
- fee services, 8-14
- Fn key function, 2-13
- fuel-gauge
 - Fn key function, 2-14
 - using, 4-8

H

- handling precautions, 2-16
- hardware resource conflicts, A-1
- help, 8-13
- hard disk standby mode, 4-14
- hibernation
 - file, creating, 4-15
- hibernation mode
 - defined, 4-15
 - Fn key function, 2-13
 - points to consider, 4-17

I

- information notices, vii
- I/O address, system resource, A-2
- IRQ, system resource, A-2

L

- locations
 - bottom view, 2-5
 - front view, 2-3
 - rear view, 2-5
- locking devices, 5-8
- low battery condition, 4-8

M

- memory
 - increasing capacity, 6-8
 - memory address, system resource, A-2
- mouse
 - using with TrackPoint III, 6-11

N

- nameplate, 5-9
- network and server support services, 8-17
- Notebook Manager, 3-3
 - boot device, 3-6
 - display, 3-11
 - hotkey icon, 3-8
 - IDE adapter, 3-12
 - information viewer, 3-4
 - password, 3-7
 - POST, 3-5
 - power saving, 3-9
 - startup, changing, 3-6
- numeric keypad, operating, 2-15

O

- Online Housecall, 8-14
- online information services, 8-15
- operating systems
 - IBM PC DOS Version 7.0, installing, 7-6
 - Windows 3.11, installing, 7-9
 - Windows 95, installing, 7-15

P

- password
 - power-on password, 5-2
 - setup password, 5-5
 - using BIOS utility, C-10
- PC Cards (PCMCIA)
 - installing, 6-4
 - removing, 6-7
- power cords, D-5
- power-on password
 - changing, 5-3
 - entering, 5-3
 - removing, 5-3
 - setting, 5-2
- printer
 - attaching, 6-13
- problems, 8-2
 - audio, 8-4
 - display, 8-3, 8-4
 - general, 8-2
 - keyboard, 8-3
 - PC Card, 8-5
 - printer, 8-4
 - serial mouse, 8-3
- PRODIGY online service, 8-16
- publications, ordering, 8-19

R

- recording identification numbers, 8-12
- recording your computer problem, 8-11
- repair services, 8-18

S

- safety notice, xi
- sales information, 8-13
- screen messages
 - password prompt, 3-2
 - power-on self-test (POST) error, 3-2
- security
 - locks, 5-8
 - passwords, 5-2
- serial number, 8-12
- Service, 8-13
- Service Pack, 8-19
- setup password
 - changing, 5-6
 - entering, 5-6
 - removing, 5-6
 - setting, 5-5
- Sleep Manager, 4-15

- software, 7-2
- standby mode
 - defined, 4-14
 - Fn key function, 2-13
 - points to consider, 4-14
- startup, changing
 - using BIOS utility, C-8
- support line services
 - ordering, 8-17
- system resource list, A-2
- system status indicators, 2-6
 - battery, 2-7
 - caps lock, 2-7
 - hard disk or CD-ROM in use, 2-7
 - location, 2-6
 - numeric lock, 2-7
 - power on, 2-7
 - scroll lock, 2-7

T

- technical support, 8-16
 - remote, 8-14
- telephone assistance, 8-13
- time and date, setting, C-5
- TrackPoint III
 - using, 2-10
- troubleshooting charts, 8-6

U

- updates
 - operating system, 8-19
- upgrading the hard disk drive, 6-2

W

- warranty
 - extensions and upgrades, 8-18
- Windows 3.11, installing, 7-9
- Windows 95, installing, 7-15

Z

- Zoomed Video port function, 3-20